

# N-Channel CICLON NexFET™ Power MOSFETs CSD16410Q5A



## Features

- Ultra Low Qg & Qgd
- Low Thermal Resistance
- Avalanche Rated
- Pb Free Terminal Plating
- RoHS Compliant
- Halogen Free



QFN 5mm x 6mm Plastic Package

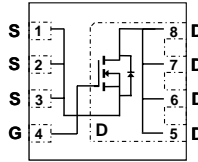

Top View

## Product Summary

$V_{DS}$	25	V
$Q_g$	3.9	nC
$Q_{gd}$	1.1	nC
$R_{DS(on)}$	$V_{GS}=4.5V$	9.6 m $\Omega$
	$V_{GS}=10V$	6.8 m $\Omega$
$V_{th}$	1.9	V

## Maximum Values ( $T_A = 25^\circ C$ unless otherwise stated)

Symbol	Parameter	Value	Units
$V_{DS}$	Drain to Source Voltage	25	V
$V_{GS}$	Gate to Source Voltage	+16 / -12	V
$I_D$	Continuous Drain Current, $T_C = 25^\circ C$	59	A
	Continuous Drain Current <sup>1</sup>	16	A
$I_{DM}$	Pulsed Drain Current, $T_A = 25^\circ C^2$	158	A
$P_D$	Power Dissipation <sup>1</sup>	3.0	W
$T_J, T_{STG}$	Operating Junction and Storage Temperature Range	-55 to 150	$^\circ C$
$E_{AS}$	Avalanche Energy, single pulse $I_D=18A, L = 0.1mH, R_G = 25\Omega$	16	mJ

1.  $R_{\theta JA} = 42^\circ C/W$  on 1in<sup>2</sup> Cu (2 oz.) on 0.060" thick FR4 PCB.
2. Pulse width  $\leq 300 \mu s$ , duty cycle  $\leq 2\%$

## $R_{DS(on)}$ vs. $V_{GS}$

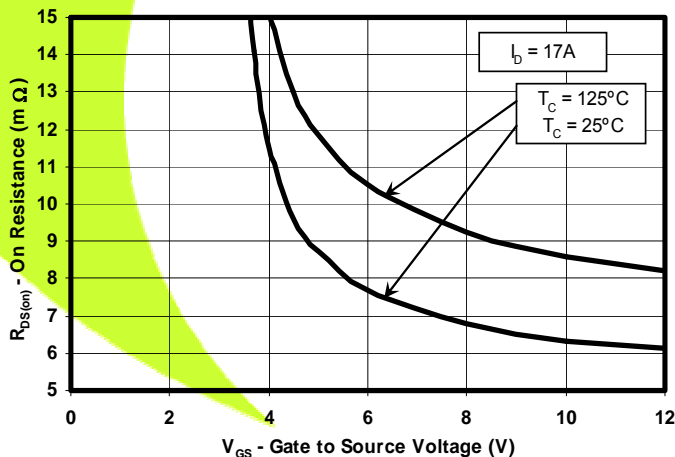

## Gate Charge

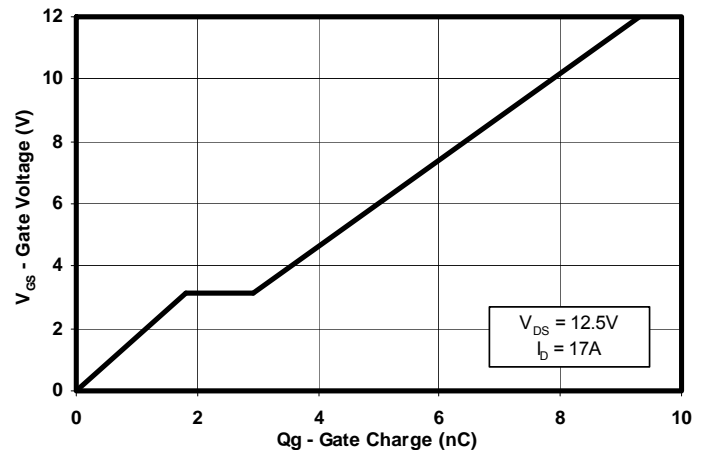

## Ordering Information

Type	Package	Package Media	Qty	Ship
CSD16410Q5A	QFN 5X6 Plastic Package	13 inch reel	2500	Tape and Reel

N-Channel  
**CICLON NexFET™ Power MOSFETs**  
**CSD16410Q5A**



**Electrical Characteristics** ( $T_A = 25^{\circ}\text{C}$  unless otherwise stated)

Symbol	Parameter	Test Conditions	Min	Typ	Max	Units
<b>Static Characteristics</b>						
$BV_{DSS}$	Drain to Source Voltage	$V_{GS} = 0V, I_D = 250\mu A$	25	—	—	V
$I_{DSS}$	Drain to Source Leakage Current	$V_{GS} = 0V, V_{DS} = 20V$	—	—	1	$\mu A$
$I_{GSS}$	Gate to Source Leakage Current	$V_{DS} = 0V, V_{GS} = +16/-12V$	—	—	100	nA
$V_{GS(th)}$	Gate to Source Threshold Voltage	$V_{DS} = V_{GS}, I_D = 250\mu A$	1.6	1.9	2.3	V
$R_{DS(on)}$	Drain to Source On Resistance	$V_{GS} = 4.5V, I_D = 17A$	—	9.6	12.0	$m\Omega$
		$V_{GS} = 10V, I_D = 17A$	—	6.8	8.5	$m\Omega$
$g_{fs}$	Transconductance	$V_{DS} = 15V, I_D = 17A$	—	38	—	S
<b>Dynamic Characteristics</b>						
$C_{ISS}$	Input Capacitance	$V_{GS} = 0V, V_{DS} = 12.5V$ $f = 1MHz$	—	570	740	pF
$C_{OSS}$	Output Capacitance		—	460	600	pF
$C_{RSS}$	Reverse Transfer Capacitance		—	40	52	pF
$R_g$	Series Gate Resistance		—	0.65	—	$\Omega$
$Q_g$	Gate Charge Total (4.5V)	$V_{DS} = 12.5V, I_D = 17A$	—	3.9	5.0	nC
$Q_{gd}$	Gate Charge Gate to Drain		—	1.1	—	nC
$Q_{gs}$	Gate Charge Gate to Source		—	1.8	—	nC
$Q_{g(th)}$	Gate Charge at $V_{th}$		—	1.1	—	nC
$Q_{OSS}$	Output Charge	$V_{DS} = 13V, V_{GS} = 0V$	—	10	—	nC
$t_{d(on)}$	Turn On Delay Time	$V_{DS} = 12.5V$ $V_{GS} = 4.5V, I_D = 17A$ $R_G = 11\Omega$	—	9.1	—	ns
$t_r$	Rise Time		—	21	—	ns
$t_{d(off)}$	Turn Off Delay Time		—	8.7	—	ns
$t_f$	Fall Time		—	13.5	—	ns
<b>Diode Characteristics</b>						
$V_{SD}$	Diode Forward Voltage	$I_S = 17A, V_{GS} = 0V$	—	0.85	1.0	V
$Q_{rr}$	Reverse Recovery Charge	$V_{dd} = 13V, I_F = 17A,$ $di/dt = 300A/\mu s$	—	14	—	nC
$t_{rr}$	Reverse Recovery Time	$V_{dd} = 13V, I_F = 17A,$ $di/dt = 300A/\mu s$	—	18.2	—	ns

# N-Channel CICLON NexFET™ Power MOSFETs CSD16410Q5A



## Thermal Characteristics ( $T_A = 25^\circ\text{C}$ unless otherwise stated)

Symbol	Parameter	Min	Typ	Max	Units
<b>Thermal Characteristics</b>					
$R_{\theta JC}$	Thermal Resistance Junction to Case <sup>3</sup>	—	—	3.8	$^\circ\text{C/W}$
$R_{\theta JA}$	Thermal Resistance Junction to Ambient <sup>3,4</sup>	—	—	52	$^\circ\text{C/W}$

- $R_{\theta JC}$  is determined with the device mounted on a 1in square 2 oz. Cu pad on a 1.5x1.5 in .060in thick FR4 board.  $R_{\theta JC}$  is guaranteed by design while  $R_{\theta ca}$  is determined by the user's board design.
- Device mounted on FR4 Material with 1in<sup>2</sup> of 2 oz. Cu.

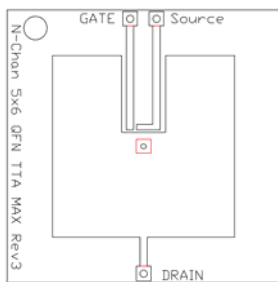

Max  $R_{\theta JA} = 52^\circ\text{C/W}$  when mounted on 1in<sup>2</sup> of 2 oz. Cu.

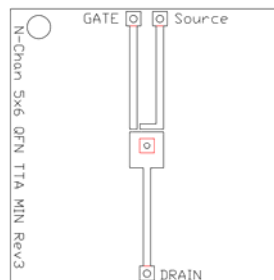

Max  $R_{\theta JA} = 121^\circ\text{C/W}$  when mounted on min pad area of 2 oz. Cu.

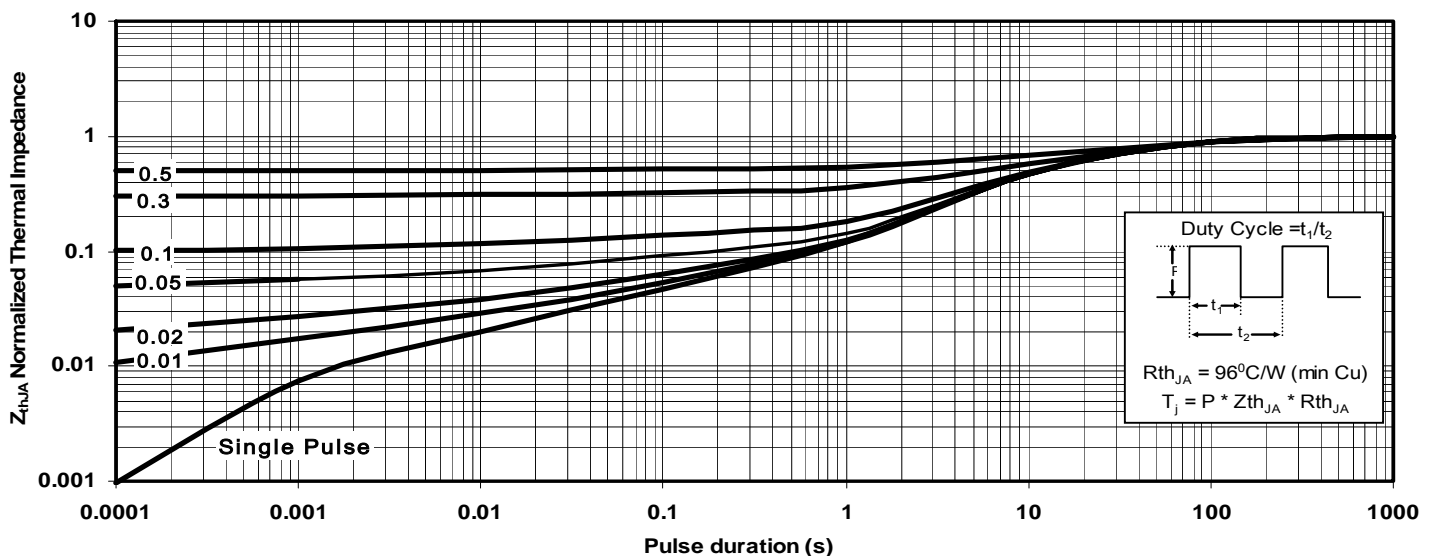

Figure 1: Transient Thermal Impedance

# N-Channel CICLON NexFET™ Power MOSFETs CSD16410Q5A



Typical MOSFET Characteristics ( $T_A = 25^\circ\text{C}$  unless otherwise stated)

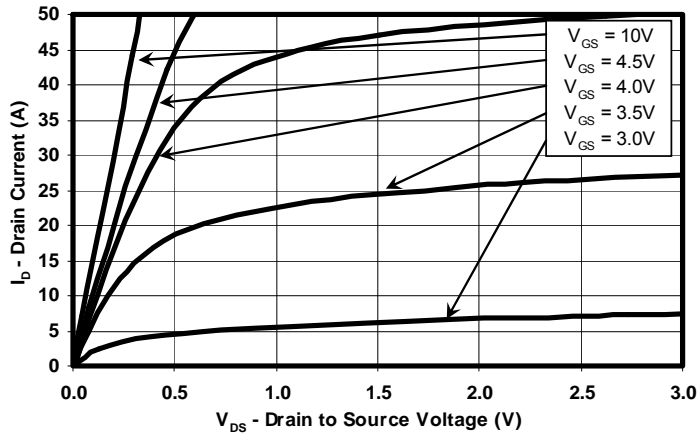

Figure 2: Saturation Characteristics

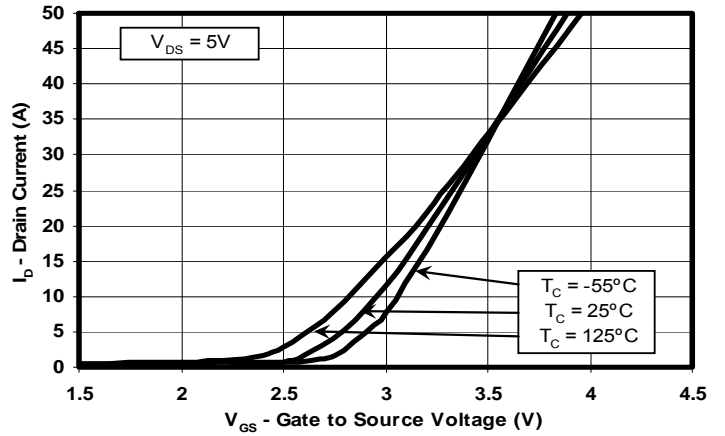

Figure 3: Transfer Characteristics

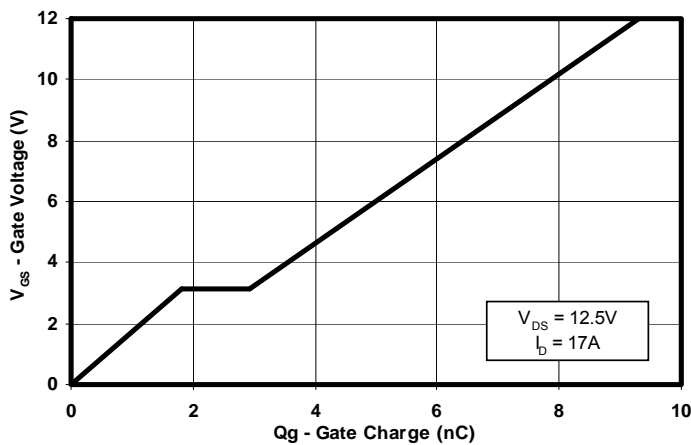

Figure 4: Gate Charge

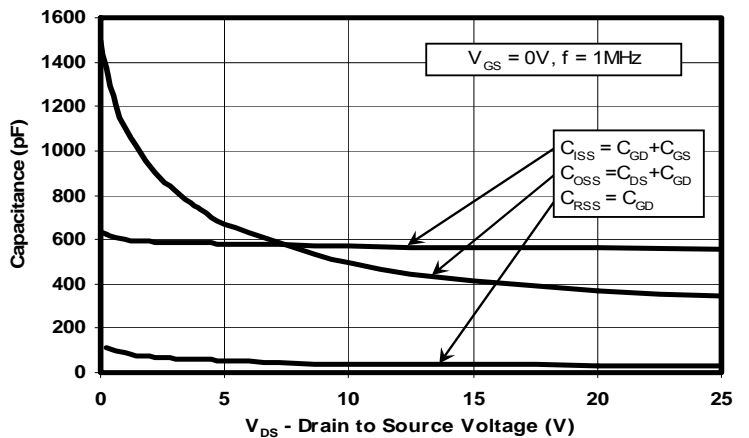

Figure 5: Capacitance

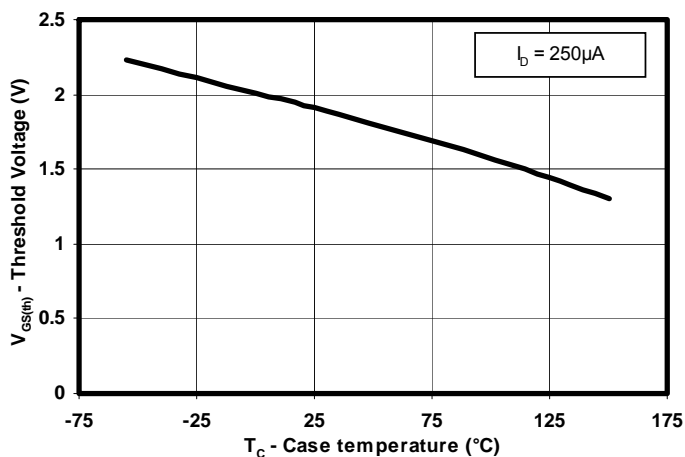

Figure 6: Threshold Voltage vs. Temperature

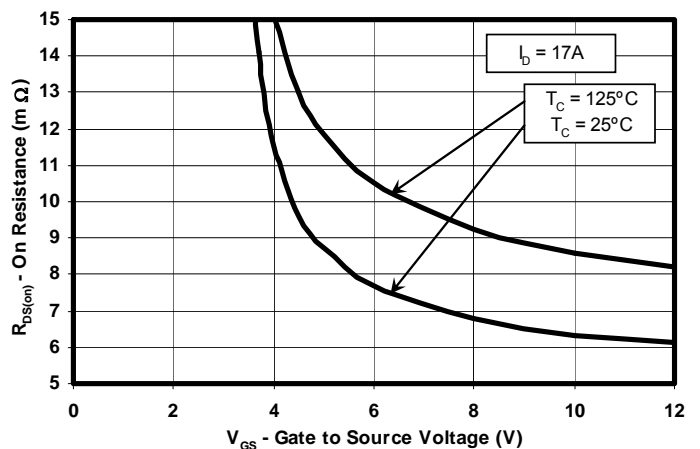

Figure 7: On Resistance vs. Gate Voltage

# N-Channel CICLON NexFET™ Power MOSFETs CSD16410Q5A



## Typical MOSFET Characteristics ( $T_A = 25^\circ\text{C}$ unless otherwise stated)

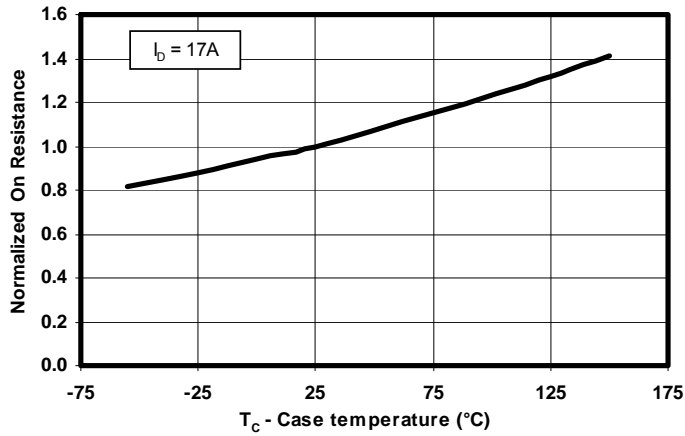

Figure 8: On Resistance vs. Temperature

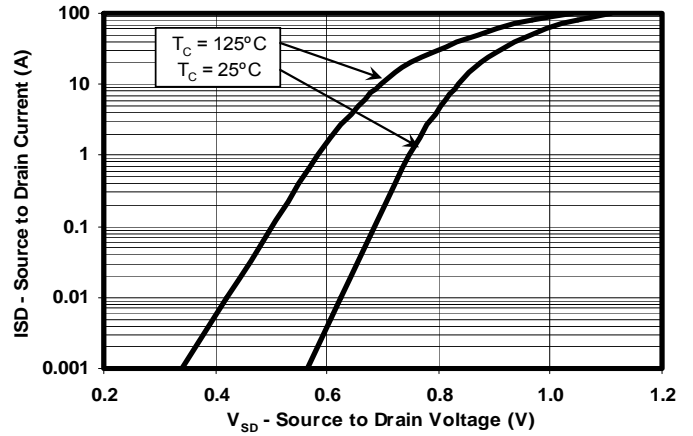

Figure 9: Typical Diode Forward Voltage

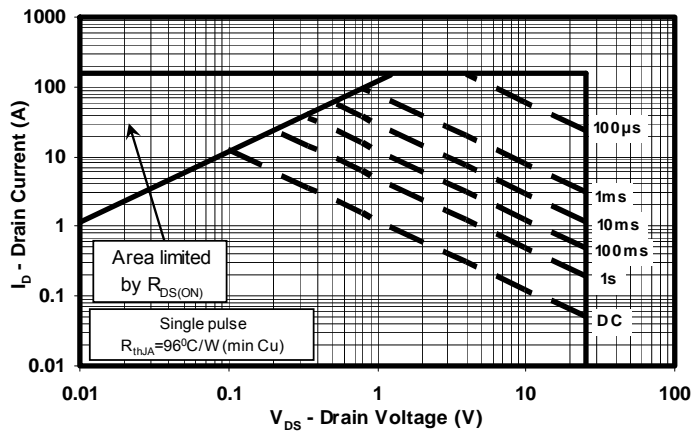

Figure 10: Maximum Safe Operating Area

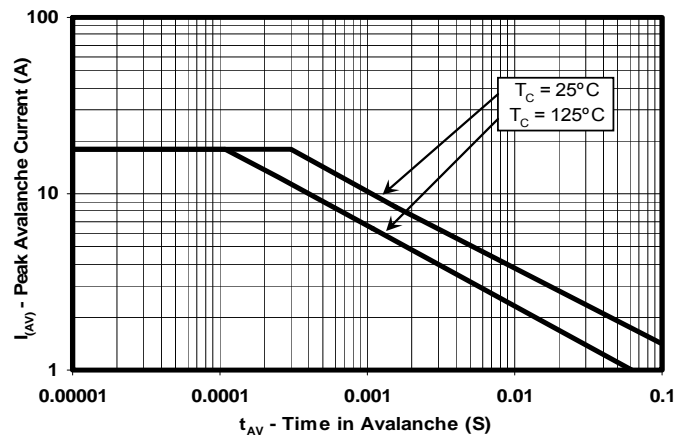

Figure 11: Single Pulse Unclamped Inductive Switching

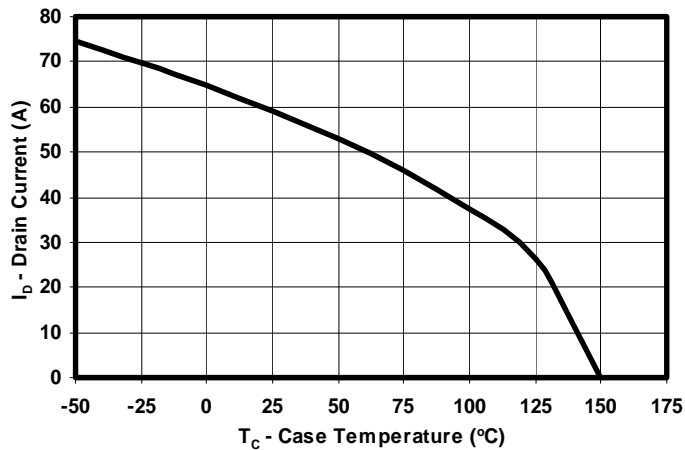
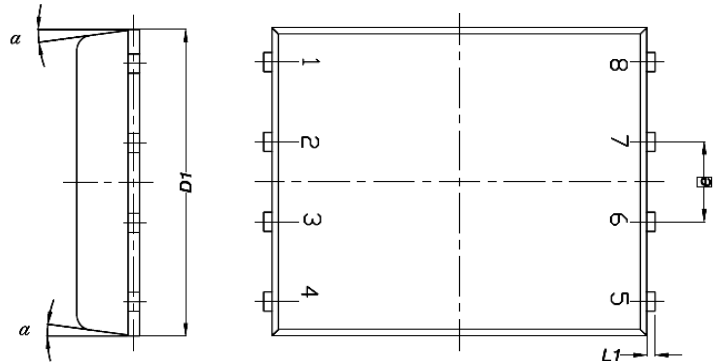
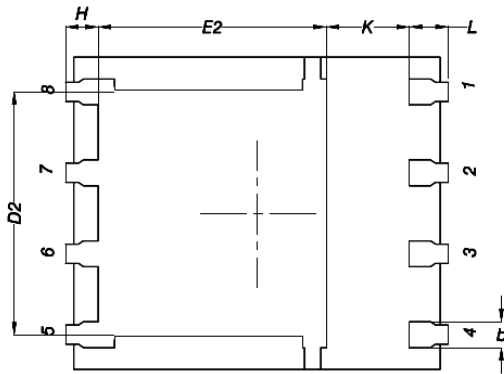

Figure 12: Maximum Drain Current vs. Temperature

N-Channel  
**CICLON** NexFET™ Power MOSFETs  
**CSD16410Q5A**



**CSD16410Q5A Package Dimensions**



RECOMMENDED PCB PATTERN

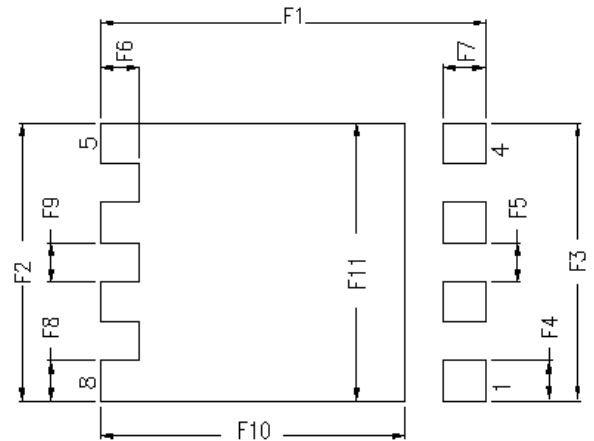

DIM	MILLIMETERS		
	MIN	NOM	MAX
A	0.90	1.00	1.10
b	0.33	0.41	0.51
c	0.20	0.25	0.30
D1	4.80	4.90	5.00
D2	3.61	3.81	3.96
E	5.90	6.00	6.10
E1	5.70	5.75	5.80
E2	3.38	3.58	3.78
e	1.27 BSC		
H	0.41	0.51	0.61
K	1.10		
L	0.51	0.61	0.71
L1	0.06	0.13	0.20
a	0°		12°

DIM	MILLIMETERS		INCHES	
	Min	Max	Min	Max
F1	6.205	6.305	0.244	0.248
F2	4.46	4.56	0.176	0.18
F3	4.46	4.56	0.176	0.18
F4	0.65	0.7	0.026	0.028
F5	0.62	0.67	0.024	0.026
F6	0.63	0.68	0.025	0.027
F7	0.7	0.8	0.028	0.031
F8	0.65	0.7	0.026	0.028
F9	0.62	0.67	0.024	0.026
F10	4.9	5	0.193	0.197
F11	4.46	4.56	0.176	0.18

# N-Channel CICLON NexFET™ Power MOSFETs CSD16410Q5A



## Q5A Tape and Reel Information

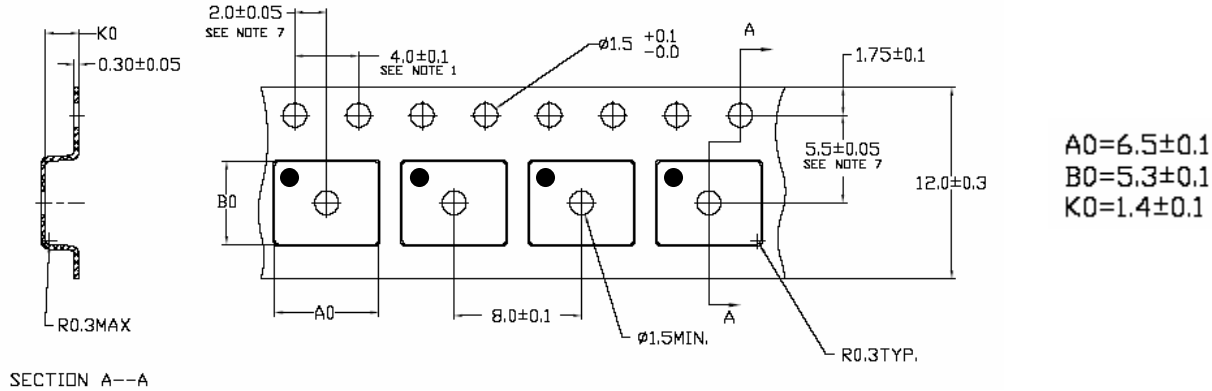

### Note:

1. 10 SPROCKET HOLE PITCH CUMULATIVE TOLERANCE +/-0.2
2. CAMBER NOT TO EXCEED 1mm IN 100mm, NONCUMULATIVE OVER 250mm
3. MATERIAL:BLACK STATIC DISSIPATIVE POLYSTYRENE
4. ALL DIMENSIONS ARE IN mm (UNLESS OTHERWISE SPECIFIED)
5. A0 AND B0 MEASURED ON A PLANE 0.3mm ABOVE THE BOTTOM OF THE POCKET

## Package Marking Information

Location:

### 1st Line

CSD = Fixed Characters

NNNN = Product Code

### 2nd Line (Date Code)

YY = Last 2 digits of the Year

WW = 2-digit Work Week

C = Country of Origin

> Philippines = P

> Taiwan = T

> China = C

### 3rd Line

LLLLL = Last 5 digits of the Wafer Lot #

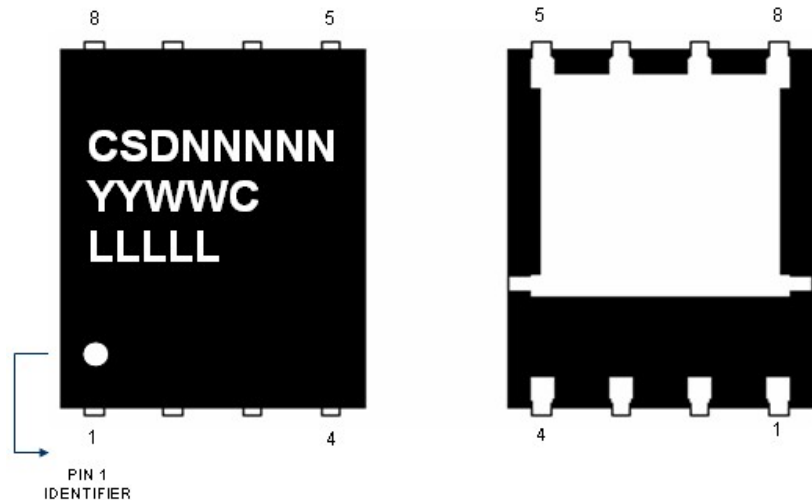

N-Channel  
**CICLON** NexFET™ Power MOSFETs  
CSD16410Q5A



**Disclaimer**

**CICLON** Semiconductor Device Corp. ("**CICLON**") reserves the right to make corrections, modifications, enhancements, improvements and other changes to its products and services at any time and to discontinue any product or service without notice. Customers should obtain the latest relevant information before placing orders and should verify that such information is current and complete. All products are sold subject to **CICLON**'s terms and conditions of sale supplied at the time of order acknowledgement.

**Additional Information**

For further information on technology, delivery terms and conditions, or pricing please contact your nearest **CICLON** Semiconductor representative.

**CICLON** Semiconductor Device Corp.  
116 Research Drive, Bethlehem, PA 18015  
**T** 610-849-5100 **F** 610-849-5101



**PACKAGING INFORMATION**

Orderable Device	Status <sup>(1)</sup>	Package Type	Package Drawing	Pins	Package Qty	Eco Plan <sup>(2)</sup>	Lead/Ball Finish	MSL Peak Temp <sup>(3)</sup>
CSD16410Q5A	ACTIVE	SON	DQJ	8	2500	Green (RoHS & no Sb/Br)	CU SN	Level-1-260C-UNLIM

<sup>(1)</sup> The marketing status values are defined as follows:

**ACTIVE:** Product device recommended for new designs.

**LIFEBUY:** TI has announced that the device will be discontinued, and a lifetime-buy period is in effect.

**NRND:** Not recommended for new designs. Device is in production to support existing customers, but TI does not recommend using this part in a new design.

**PREVIEW:** Device has been announced but is not in production. Samples may or may not be available.

**OBSOLETE:** TI has discontinued the production of the device.

<sup>(2)</sup> Eco Plan - The planned eco-friendly classification: Pb-Free (RoHS), Pb-Free (RoHS Exempt), or Green (RoHS & no Sb/Br) - please check <http://www.ti.com/productcontent> for the latest availability information and additional product content details.

**TBD:** The Pb-Free/Green conversion plan has not been defined.

**Pb-Free (RoHS):** TI's terms "Lead-Free" or "Pb-Free" mean semiconductor products that are compatible with the current RoHS requirements for all 6 substances, including the requirement that lead not exceed 0.1% by weight in homogeneous materials. Where designed to be soldered at high temperatures, TI Pb-Free products are suitable for use in specified lead-free processes.

**Pb-Free (RoHS Exempt):** This component has a RoHS exemption for either 1) lead-based flip-chip solder bumps used between the die and package, or 2) lead-based die adhesive used between the die and leadframe. The component is otherwise considered Pb-Free (RoHS compatible) as defined above.

**Green (RoHS & no Sb/Br):** TI defines "Green" to mean Pb-Free (RoHS compatible), and free of Bromine (Br) and Antimony (Sb) based flame retardants (Br or Sb do not exceed 0.1% by weight in homogeneous material)

<sup>(3)</sup> MSL, Peak Temp. -- The Moisture Sensitivity Level rating according to the JEDEC industry standard classifications, and peak solder temperature.

**Important Information and Disclaimer:**The information provided on this page represents TI's knowledge and belief as of the date that it is provided. TI bases its knowledge and belief on information provided by third parties, and makes no representation or warranty as to the accuracy of such information. Efforts are underway to better integrate information from third parties. TI has taken and continues to take reasonable steps to provide representative and accurate information but may not have conducted destructive testing or chemical analysis on incoming materials and chemicals. TI and TI suppliers consider certain information to be proprietary, and thus CAS numbers and other limited information may not be available for release.

In no event shall TI's liability arising out of such information exceed the total purchase price of the TI part(s) at issue in this document sold by TI to Customer on an annual basis.

## IMPORTANT NOTICE

Texas Instruments Incorporated and its subsidiaries (TI) reserve the right to make corrections, modifications, enhancements, improvements, and other changes to its products and services at any time and to discontinue any product or service without notice. Customers should obtain the latest relevant information before placing orders and should verify that such information is current and complete. All products are sold subject to TI's terms and conditions of sale supplied at the time of order acknowledgment.

TI warrants performance of its hardware products to the specifications applicable at the time of sale in accordance with TI's standard warranty. Testing and other quality control techniques are used to the extent TI deems necessary to support this warranty. Except where mandated by government requirements, testing of all parameters of each product is not necessarily performed.

TI assumes no liability for applications assistance or customer product design. Customers are responsible for their products and applications using TI components. To minimize the risks associated with customer products and applications, customers should provide adequate design and operating safeguards.

TI does not warrant or represent that any license, either express or implied, is granted under any TI patent right, copyright, mask work right, or other TI intellectual property right relating to any combination, machine, or process in which TI products or services are used. Information published by TI regarding third-party products or services does not constitute a license from TI to use such products or services or a warranty or endorsement thereof. Use of such information may require a license from a third party under the patents or other intellectual property of the third party, or a license from TI under the patents or other intellectual property of TI.

Reproduction of TI information in TI data books or data sheets is permissible only if reproduction is without alteration and is accompanied by all associated warranties, conditions, limitations, and notices. Reproduction of this information with alteration is an unfair and deceptive business practice. TI is not responsible or liable for such altered documentation. Information of third parties may be subject to additional restrictions.

Resale of TI products or services with statements different from or beyond the parameters stated by TI for that product or service voids all express and any implied warranties for the associated TI product or service and is an unfair and deceptive business practice. TI is not responsible or liable for any such statements.

TI products are not authorized for use in safety-critical applications (such as life support) where a failure of the TI product would reasonably be expected to cause severe personal injury or death, unless officers of the parties have executed an agreement specifically governing such use. Buyers represent that they have all necessary expertise in the safety and regulatory ramifications of their applications, and acknowledge and agree that they are solely responsible for all legal, regulatory and safety-related requirements concerning their products and any use of TI products in such safety-critical applications, notwithstanding any applications-related information or support that may be provided by TI. Further, Buyers must fully indemnify TI and its representatives against any damages arising out of the use of TI products in such safety-critical applications.

TI products are neither designed nor intended for use in military/aerospace applications or environments unless the TI products are specifically designated by TI as military-grade or "enhanced plastic." Only products designated by TI as military-grade meet military specifications. Buyers acknowledge and agree that any such use of TI products which TI has not designated as military-grade is solely at the Buyer's risk, and that they are solely responsible for compliance with all legal and regulatory requirements in connection with such use.

TI products are neither designed nor intended for use in automotive applications or environments unless the specific TI products are designated by TI as compliant with ISO/TS 16949 requirements. Buyers acknowledge and agree that, if they use any non-designated products in automotive applications, TI will not be responsible for any failure to meet such requirements.

Following are URLs where you can obtain information on other Texas Instruments products and application solutions:

### Products

Amplifiers	<a href="http://amplifier.ti.com">amplifier.ti.com</a>
Data Converters	<a href="http://dataconverter.ti.com">dataconverter.ti.com</a>
DLP® Products	<a href="http://www.dlp.com">www.dlp.com</a>
DSP	<a href="http://dsp.ti.com">dsp.ti.com</a>
Clocks and Timers	<a href="http://www.ti.com/clocks">www.ti.com/clocks</a>
Interface	<a href="http://interface.ti.com">interface.ti.com</a>
Logic	<a href="http://logic.ti.com">logic.ti.com</a>
Power Mgmt	<a href="http://power.ti.com">power.ti.com</a>
Microcontrollers	<a href="http://microcontroller.ti.com">microcontroller.ti.com</a>
RFID	<a href="http://www.ti-rfid.com">www.ti-rfid.com</a>
RF/IF and ZigBee® Solutions	<a href="http://www.ti.com/lprf">www.ti.com/lprf</a>

### Applications

Audio	<a href="http://www.ti.com/audio">www.ti.com/audio</a>
Automotive	<a href="http://www.ti.com/automotive">www.ti.com/automotive</a>
Broadband	<a href="http://www.ti.com/broadband">www.ti.com/broadband</a>
Digital Control	<a href="http://www.ti.com/digitalcontrol">www.ti.com/digitalcontrol</a>
Medical	<a href="http://www.ti.com/medical">www.ti.com/medical</a>
Military	<a href="http://www.ti.com/military">www.ti.com/military</a>
Optical Networking	<a href="http://www.ti.com/opticalnetwork">www.ti.com/opticalnetwork</a>
Security	<a href="http://www.ti.com/security">www.ti.com/security</a>
Telephony	<a href="http://www.ti.com/telephony">www.ti.com/telephony</a>
Video & Imaging	<a href="http://www.ti.com/video">www.ti.com/video</a>
Wireless	<a href="http://www.ti.com/wireless">www.ti.com/wireless</a>

Mailing Address: Texas Instruments, Post Office Box 655303, Dallas, Texas 75265  
Copyright © 2009, Texas Instruments Incorporated