

MJH10012
(See MJ10012)

Complementary Darlington Silicon Power Transistors

... designed for use as general purpose amplifiers, low frequency switching and motor control applications.

- High DC Current Gain @ 10 Adc — $h_{FE} = 400$ Min (All Types)
- Collector–Emitter Sustaining Voltage
 $V_{CE(sus)} = 150$ Vdc (Min) — MJH11018, 17
 $= 200$ Vdc (Min) — MJH11020, 19
 $= 250$ Vdc (Min) — MJH11022, 21
- Low Collector–Emitter Saturation Voltage
 $V_{CE(sat)} = 1.2$ V (Typ) @ $I_C = 5.0$ A
 $= 1.8$ V (Typ) @ $I_C = 10$ A
- Monolithic Construction

PNP
MJH11017*
MJH11019*
MJH11021*
NPN
MJH11018*
MJH11020*
MJH11022*

*Motorola Preferred Device

**15 AMPERE
DARLINGTON
COMPLEMENTARY SILICON
POWER TRANSISTORS
150, 200, 250 VOLTS
150 WATTS**

MAXIMUM RATINGS

Rating	Symbol	MJH			Unit
		11018 11017	11020 11019	11022 11021	
Collector–Emitter Voltage	V_{CEO}	150	200	250	Vdc
Collector–Base Voltage	V_{CB}	150	200	250	Vdc
Emitter–Base Voltage	V_{EB}	5.0			Vdc
Collector Current — Continuous — Peak (1)	I_C	15 30			Adc
Base Current	I_B	0.5			Adc
Total Device Dissipation @ $T_C = 25^\circ\text{C}$ Derate Above 25°C	P_D	150 1.2			Watts W/ $^\circ\text{C}$
Operating and Storage Junction Temperature Range	T_J, T_{stg}	–65 to +150			$^\circ\text{C}$

THERMAL CHARACTERISTICS

Characteristic	Symbol	Max	Unit
Thermal Resistance, Junction to Case	$R_{\theta JC}$	0.83	$^\circ\text{C}/\text{W}$

(1) Pulse Test: Pulse Width = 5.0 ms, Duty Cycle $\leq 10\%$.

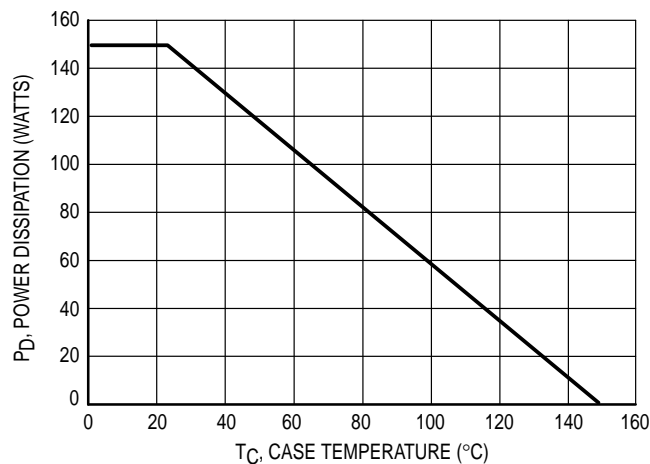
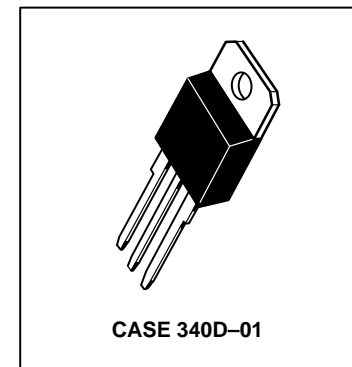

Figure 1. Power Derating



Preferred devices are Motorola recommended choices for future use and best overall value.

MJH11017 MJH11019 MJH11021 MJH11018 MJH11020 MJH11022

ELECTRICAL CHARACTERISTICS ($T_C = 25^\circ\text{C}$ unless otherwise noted)

Characteristic	Symbol	Min	Max	Unit
OFF CHARACTERISTICS				
Collector–Emitter Sustaining Voltage (1) ($I_C = 0.1 \text{ Adc}$, $I_B = 0$)	$V_{CEO(sus)}$	150 200 250	—	Vdc
Collector Cutoff Current ($V_{CE} = 75 \text{ Vdc}$, $I_B = 0$) ($V_{CE} = 100 \text{ Vdc}$, $I_B = 0$) ($V_{CE} = 125 \text{ Vdc}$, $I_B = 0$)	I_{CEO}	— — —	1.0 1.0 1.0	mAdc
Collector Cutoff Current ($V_{CE} = \text{Rated } V_{CB}$, $V_{BE(off)} = 1.5 \text{ Vdc}$) ($V_{CE} = \text{Rated } V_{CB}$, $V_{BE(off)} = 1.5 \text{ Vdc}$, $T_J = 150^\circ\text{C}$)	I_{CEV}	— —	0.5 5.0	mAdc
Emitter Cutoff Current ($V_{BE} = 5.0 \text{ Vdc}$, $I_C = 0$)	I_{EBO}	—	2.0	mAdc

ON CHARACTERISTICS (1)

DC Current Gain ($I_C = 10 \text{ Adc}$, $V_{CE} = 5.0 \text{ Vdc}$) ($I_C = 15 \text{ Adc}$, $V_{CE} = 5.0 \text{ Vdc}$)	h_{FE}	400 100	15,000 —	—
Collector–Emitter Saturation Voltage ($I_C = 10 \text{ Adc}$, $I_B = 100 \text{ mA}$) ($I_C = 15 \text{ Adc}$, $I_B = 150 \text{ mA}$)	$V_{CE(sat)}$	— —	2.5 4.0	Vdc
Base–Emitter On Voltage ($I_C = 10 \text{ A}$, $V_{CE} = 5.0 \text{ Vdc}$)	$V_{BE(on)}$	—	2.8	Vdc
Base–Emitter Saturation Voltage ($I_C = 15 \text{ Adc}$, $I_B = 150 \text{ mA}$)	$V_{BE(sat)}$	—	3.8	Vdc

DYNAMIC CHARACTERISTICS

Current–Gain Bandwidth Product ($I_C = 10 \text{ Adc}$, $V_{CE} = 3.0 \text{ Vdc}$, $f = 1.0 \text{ MHz}$)	f_T	3.0	—	—
Output Capacitance ($V_{CB} = 10 \text{ Vdc}$, $I_E = 0$, $f = 0.1 \text{ MHz}$)	C_{ob}	— —	400 600	pF
Small–Signal Current Gain ($I_C = 10 \text{ Adc}$, $V_{CE} = 3.0 \text{ Vdc}$, $f = 1.0 \text{ kHz}$)	h_{fe}	75	—	—

SWITCHING CHARACTERISTICS

Characteristic	Symbol	Typical		Unit
		NPN	PNP	
Delay Time	t_d	150	75	ns
Rise Time	t_r	1.2	0.5	μs
Storage Time	t_s	4.4	2.7	μs
Fall Time	t_f	2.5	2.5	μs

(1) Pulse Test: Pulse Width = 300 μs , Duty Cycle $\leq 2.0\%$.

R_B & R_C varied to obtain desired current levels
 D_1 , must be fast recovery types, e.g.:
 1N5825 used above $I_B \approx 100 \text{ mA}$
 MSD6100 used below $I_B \approx 100 \text{ mA}$

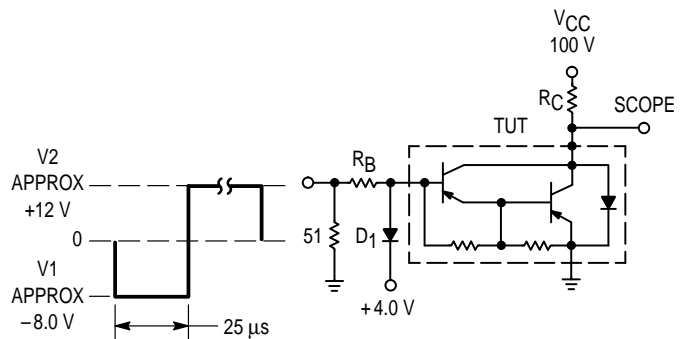

t_r , $t_f \leq 10 \text{ ns}$
 Duty Cycle = 1.0%

For t_d and t_r , D_1 is disconnected and $V_2 = 0$
 For NPN test circuit, reverse diode and voltage polarities.

Figure 2. Switching Times Test Circuit

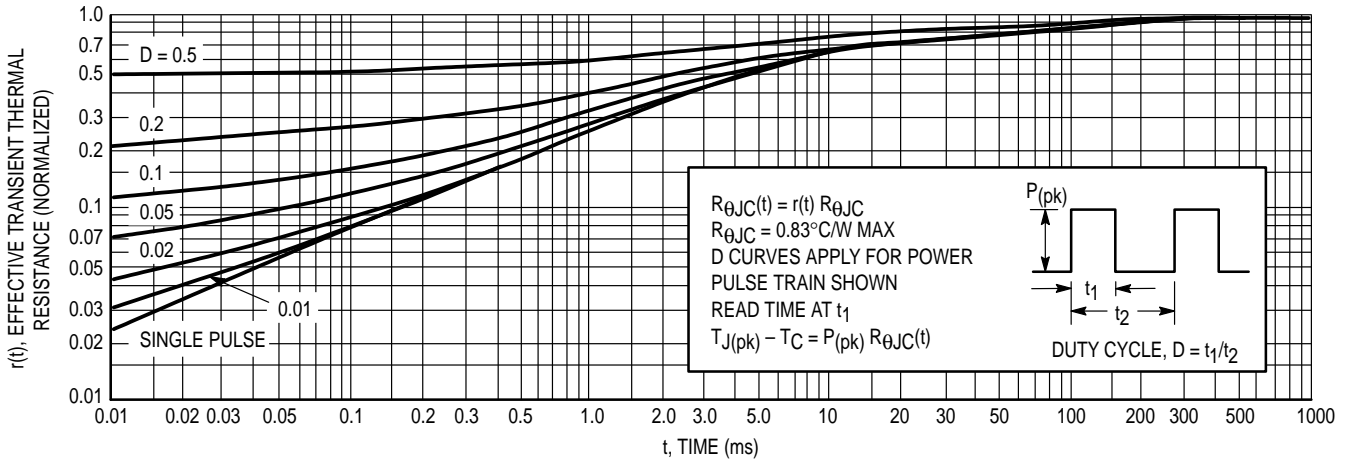

Figure 3. Thermal Response

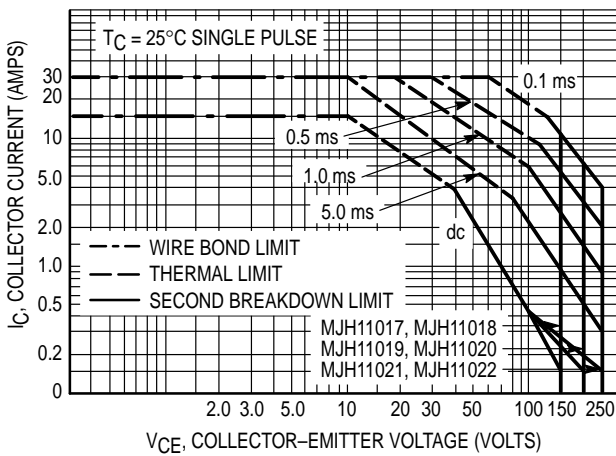

Figure 4. Maximum Rated Forward Bias Safe Operating Area (FBSOA)

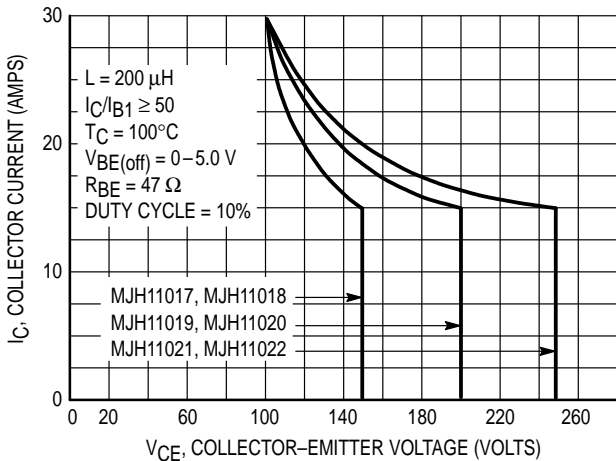

Figure 5. Maximum Rated Reverse Bias Safe Operating Area (RBSOA)

FORWARD BIAS

There are two limitations on the power handling ability of a transistor: average junction temperature and second breakdown. Safe operating area curves indicate $I_C - V_{CE}$ limits of the transistor that must be observed for reliable operation; i.e., the transistor must not be subjected to greater dissipation than the curves indicate.

The data of Figure 4 is based on $T_J(\text{pk}) = 150^{\circ}\text{C}$; T_C is variable depending on conditions. Second breakdown pulse limits are valid for duty cycles to 10% provided $T_J(\text{pk}) \leq 150^{\circ}\text{C}$. $T_J(\text{pk})$ may be calculated from the data in Figure 3. At high case temperatures, thermal limitations will reduce the power that can be handled to values less than the limitations imposed by second breakdown.

REVERSE BIAS

For inductive loads, high voltage and high current must be sustained simultaneously during turn-off, in most cases, with the base to emitter junction reverse biased. Under these conditions the collector voltage must be held to a safe level at or below a specific value of collector current. This can be accomplished by several means such as active clamping, RC snubbing, load line shaping, etc. The safe level for these devices is specified as Reverse Bias Safe Operating Area and represents the voltage-current conditions during reverse biased turn-off. This rating is verified under clamped conditions so that the device is never subjected to an avalanche mode. Figure 5 gives RBSOA characteristics.

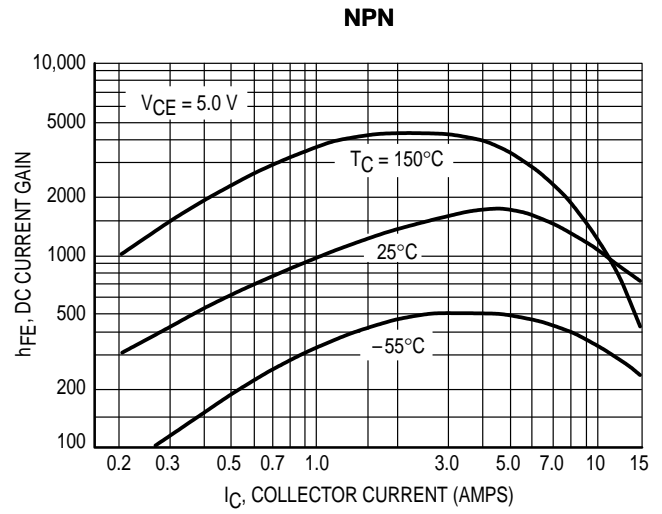
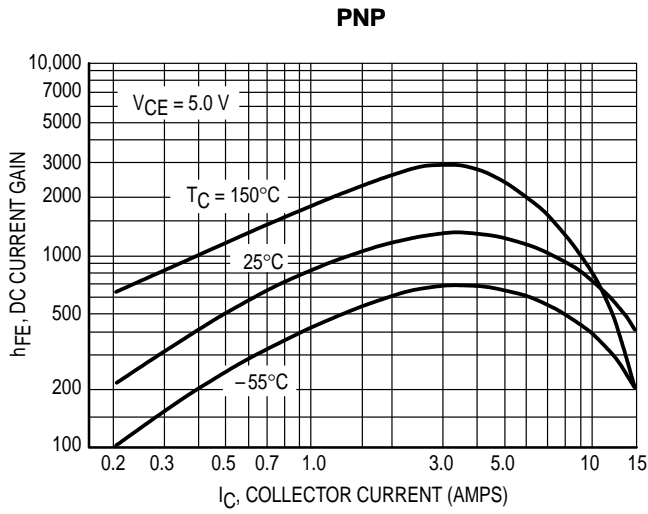

Figure 6. DC Current Gain

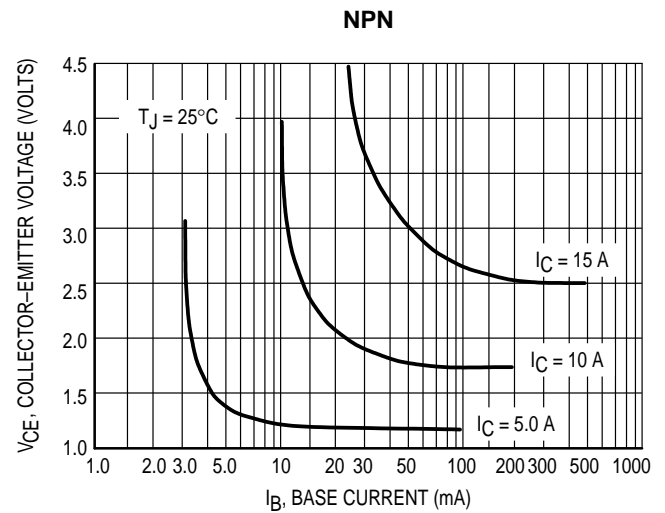
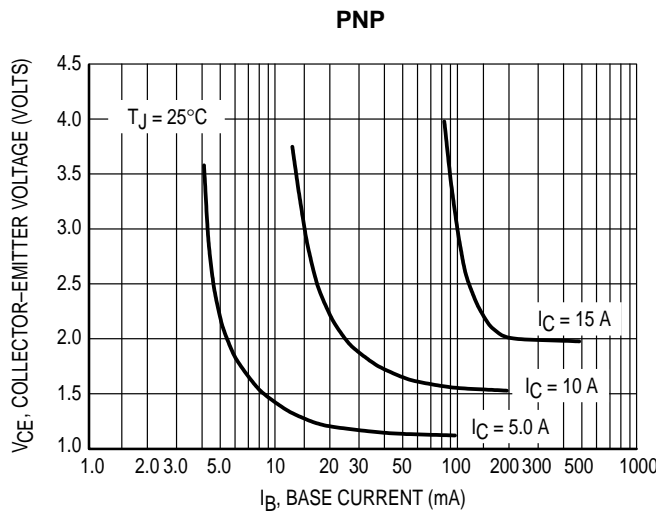

Figure 7. Collector Saturation Region

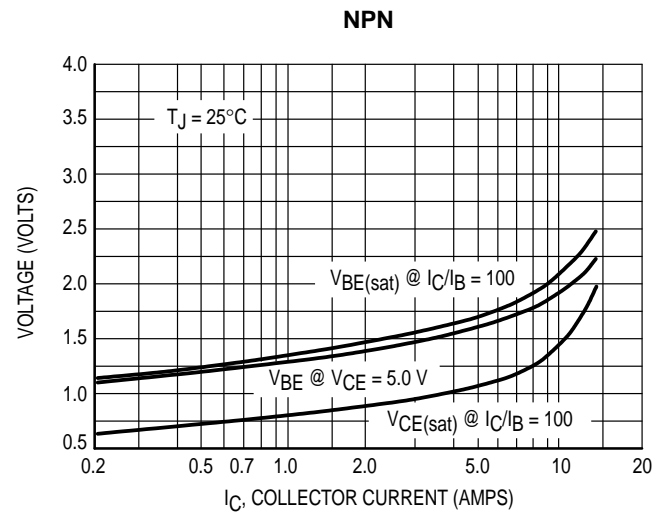
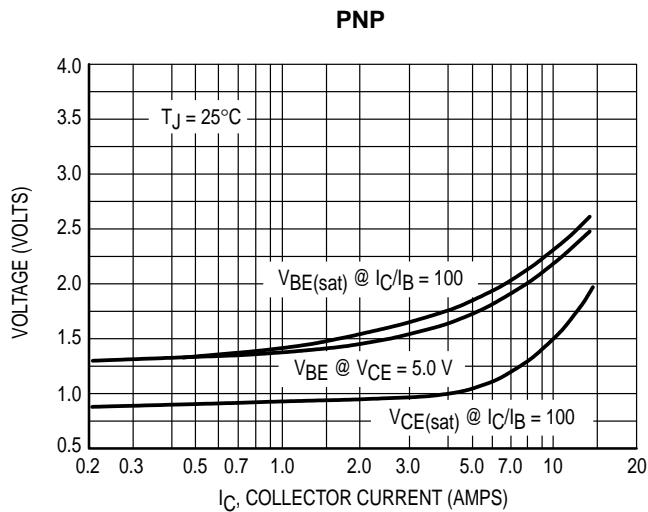

Figure 8. "On" Voltages

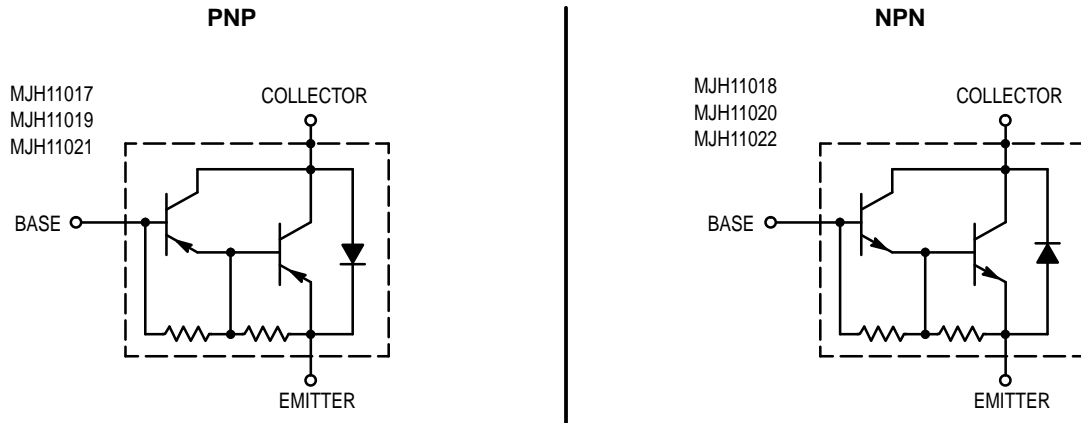
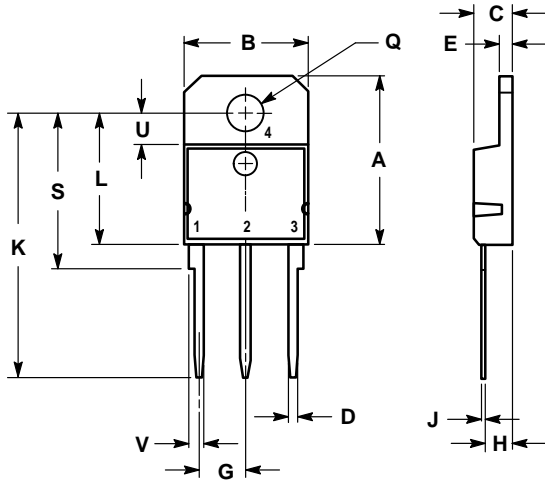

Figure 9. Darlington Schematic

PACKAGE DIMENSIONS



NOTES:
 1. DIMENSIONING AND TOLERANCING PER ANSI Y14.5M, 1982.
 2. CONTROLLING DIMENSION: MILLIMETER.

DIM	MILLIMETERS		INCHES	
	MIN	MAX	MIN	MAX
A	19.00	19.60	0.749	0.771
B	14.00	14.50	0.551	0.570
C	4.20	4.70	0.165	0.185
D	1.00	1.30	0.040	0.051
E	1.45	1.65	0.058	0.064
G	5.21	5.72	0.206	0.225
H	2.60	3.00	0.103	0.118
J	0.40	0.60	0.016	0.023
K	28.50	32.00	1.123	1.259
L	14.70	15.30	0.579	0.602
Q	4.00	4.25	0.158	0.167
S	17.50	18.10	0.689	0.712
U	3.40	3.80	0.134	0.149
V	1.50	2.00	0.060	0.078

STYLE 1:
 PIN 1: BASE
 2. COLLECTOR
 3. EMITTER
 4. COLLECTOR

CASE 340D-01
SOT 93, TO-218 TYPE
ISSUE A

Motorola reserves the right to make changes without further notice to any products herein. Motorola makes no warranty, representation or guarantee regarding the suitability of its products for any particular purpose, nor does Motorola assume any liability arising out of the application or use of any product or circuit, and specifically disclaims any and all liability, including without limitation consequential or incidental damages. "Typical" parameters can and do vary in different applications. All operating parameters, including "Typicals" must be validated for each customer application by customer's technical experts. Motorola does not convey any license under its patent rights nor the rights of others. Motorola products are not designed, intended, or authorized for use as components in systems intended for surgical implant into the body, or other applications intended to support or sustain life, or for any other application in which the failure of the Motorola product could create a situation where personal injury or death may occur. Should Buyer purchase or use Motorola products for any such unintended or unauthorized application, Buyer shall indemnify and hold Motorola and its officers, employees, subsidiaries, affiliates, and distributors harmless against all claims, costs, damages, and expenses, and reasonable attorney fees arising out of, directly or indirectly, any claim of personal injury or death associated with such unintended or unauthorized use, even if such claim alleges that Motorola was negligent regarding the design or manufacture of the part. Motorola and are registered trademarks of Motorola, Inc. Motorola, Inc. is an Equal Opportunity/Affirmative Action Employer.

How to reach us:
USA/EUROPE: Motorola Literature Distribution;
 P.O. Box 20912; Phoenix, Arizona 85036. 1-800-441-2447

JAPAN: Nippon Motorola Ltd.; Tatsumi-SPD-JLDC, Toshikatsu Otsuki,
 6F Seibu-Butsuryu-Center, 3-14-2 Tatsumi Koto-Ku, Tokyo 135, Japan. 03-3521-8315

MFAX: RMFAX0@email.sps.mot.com - TOUCHTONE (602) 244-6609
INTERNET: http://Design-NET.com

HONG KONG: Motorola Semiconductors H.K. Ltd.; 8B Tai Ping Industrial Park,
 51 Ting Kok Road, Tai Po, N.T., Hong Kong. 852-26629298

