

# Low Noise, Cascadable Silicon Bipolar MMIC Amplifier

## Technical Data

**INA-03184**

### Features

- **Cascadable 50  $\Omega$  Gain Block**
- **Low Noise Figure:**  
2.6 dB Typical at 1.5 GHz
- **High Gain:**  
25 dB Typical at 1.5 GHz
- **3 dB Bandwidth:**  
DC to 2.5 GHz
- **Unconditionally Stable**  
( $k > 1$ )
- **Low Power Dissipation:**  
10 mA Bias
- **Low Cost Plastic Package**

### Description

The INA-03184 is a low-noise silicon bipolar Monolithic Microwave Integrated Circuit (MMIC)

feedback amplifier housed in a low cost surface mount plastic package. It is designed for narrow or wide bandwidth commercial and industrial applications that require high gain and low noise IF or RF amplification with minimum power consumption.

The INA series of MMICs is fabricated using HP's 10 GHz  $f_T$ , 25 GHz  $f_{MAX}$ , ISOSAT™-I silicon bipolar process which uses nitride self-alignment, submicrometer lithography, trench isolation, ion implantation, gold metallization and polyimide intermetal dielectric and scratch protection to achieve excellent performance, uniformity and reliability.

### 84 Plastic Package

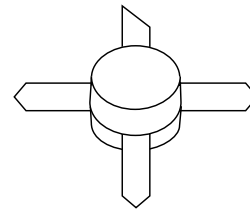

### Typical Biasing Configuration

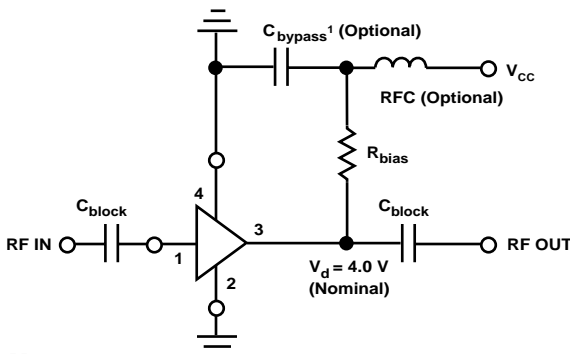

#### Note:

1. VSWR can be improved by bypassing a 100-120  $\Omega$  bias resistor directly to ground. See AN-S012: Low Noise Amplifiers.

### INA-03184 Absolute Maximum Ratings

Parameter	Absolute Maximum <sup>[1]</sup>
Device Current	25 mA
Power Dissipation <sup>[2]</sup>	200 mW
RF Input Power	+13 dBm
Junction Temperature	150°C
Storage Temperature	-65 to 150°C

#### Thermal Resistance:

$$\theta_{jc} = 100^{\circ}\text{C/W}$$

#### Notes:

1. Permanent damage may occur if any of these limits are exceeded.
2. Derate at 10 mW/°C for  $T_C > 130^{\circ}\text{C}$ .

### INA-03184 Electrical Specifications<sup>[1]</sup>, $T_A = 25^{\circ}\text{C}$

Symbol	Parameters and Test Conditions: $I_d = 10 \text{ mA}$ , $Z_0 = 50 \Omega$	Units	Min.	Typ.	Max.
$G_P$	Power Gain ( $ S_{21} ^2$ ) $f = 1.5 \text{ GHz}$	dB	23.0	25.0	
$\Delta G_P$	Gain Flatness $f = 0.1 \text{ to } 2.0 \text{ GHz}$	dB		$\pm 0.8$	
$f_3 \text{ dB}$	3 dB Bandwidth <sup>[2]</sup>	GHz		2.5	
ISO	Reverse Isolation ( $ S_{12} ^2$ ) $f = 1.5 \text{ GHz}$	dB		35	
VSWR	Input VSWR $f = 0.01 \text{ to } 2.0 \text{ GHz}$			2.0:1	
	Output VSWR $f = 0.01 \text{ to } 2.0 \text{ GHz}$			3.0:1 <sup>[3]</sup>	
NF	50 $\Omega$ Noise Figure $f = 1.5 \text{ GHz}$	dB		2.6	
$P_1 \text{ dB}$	Output Power at 1 dB Gain Compression $f = 1.5 \text{ GHz}$	dBm		-2.0	
$IP_3$	Third Order Intercept Point $f = 1.5 \text{ GHz}$	dBm		7	
$t_D$	Group Delay $f = 1.5 \text{ GHz}$	psec		210	
$V_d$	Device Voltage	V	3.0	4.0	5.0
$dV/dT$	Device Voltage Temperature Coefficient	mV/°C		+4	

#### Notes:

1. The recommended operating current range for this device is 8 to 18 mA. Typical performance as a function of current is on the following page.
2. Referenced from 10 MHz Gain ( $G_P$ ).
3. VSWR can be improved by bypassing a 100–200  $\Omega$  bias resistor directly to ground. See AN-S012: MagIC Low Noise Amplifiers.

### INA-03184 Part Number Ordering Information

Part Number	No. of Devices	Container
INA-03184-TR1	1000	7" Reel
INA-03184-BLK	100	Antistatic Bag

For more information, see "Tape and Reel Packaging for Semiconductor Devices".

### INA-03184 Typical Scattering Parameters ( $Z_O = 50 \Omega$ , $T_A = 25^\circ\text{C}$ , $I_d = 10 \text{ mA}$ )

Freq. GHz	$S_{11}$		$S_{21}$			$S_{12}$			$S_{22}$		k
	Mag	Ang	dB	Mag	Ang	dB	Mag	Ang	Mag	Ang	
0.05	.32	179	25.6	19.14	-3	-37.1	.014	3	.55	0	1.48
0.10	.32	176	25.6	19.05	-7	-37.1	.014	4	.57	-3	1.45
0.20	.32	172	25.6	19.05	-14	-37.1	.014	6	.55	-5	1.48
0.40	.32	165	25.5	18.78	-29	-37.1	.014	10	.53	-11	1.53
0.60	.32	158	25.4	18.71	-43	-36.5	.015	11	.51	-14	1.49
0.80	.32	151	25.4	18.53	-57	-36.5	.015	13	.51	-17	1.50
1.00	.32	144	25.2	18.18	-72	-35.9	.016	21	.50	-20	1.46
1.20	.30	135	25.2	18.27	-86	-35.9	.016	25	.50	-23	1.46
1.40	.31	126	25.2	18.10	-102	-35.4	.017	30	.49	-29	1.42
1.60	.30	117	25.1	17.92	-117	-34.9	.018	38	.48	-34	1.38
1.80	.26	102	24.9	17.49	-135	-34.4	.019	44	.45	-41	1.39
2.00	.22	92	24.4	16.62	-153	-34.0	.020	49	.40	-50	1.44
2.50	.09	91	22.2	12.88	168	-33.6	.021	57	.26	-48	1.87
3.00	.14	160	18.9	8.79	134	-32.8	.023	65	.22	-33	2.40
3.50	.24	151	15.4	5.92	108	-32.0	.025	69	.26	-33	3.01
4.00	.29	139	12.4	4.18	87	-30.8	.029	81	.28	-43	3.52

#### Note:

1. S-parameters are de-embedded from 70 mil package measured data using the package model found in the DEVICE MODELS section.

### INA-03184 Typical Performance, $T_A = 25^\circ\text{C}$

(unless otherwise noted)

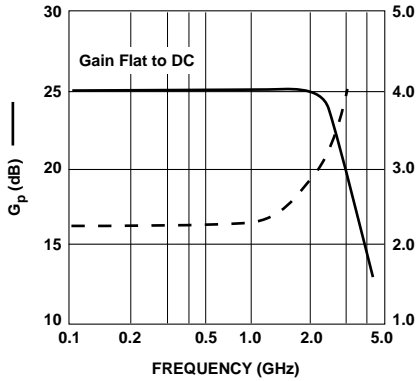

Figure 1. Typical Gain and Noise Figure vs. Frequency,  $T_A = 25^\circ\text{C}$ ,  $I_d = 10 \text{ mA}$ .

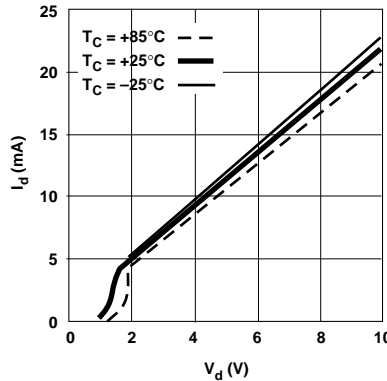

Figure 2. Device Current vs. Voltage.

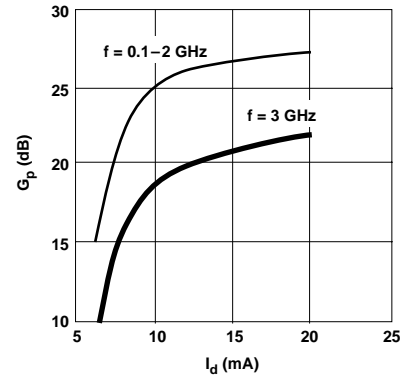

Figure 3. Power Gain vs. Current.

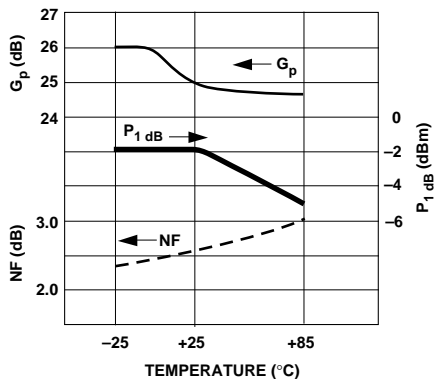

Figure 4. Output Power at 1 dB Gain Compression, NF and Power Gain vs. Case Temperature,  $f = 1.5 \text{ GHz}$ ,  $I_d = 10 \text{ mA}$ .

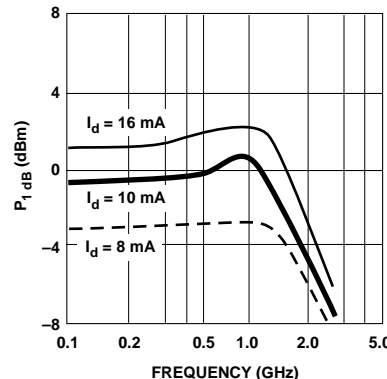

Figure 5. Output Power at 1 dB Gain Compression vs. Frequency.

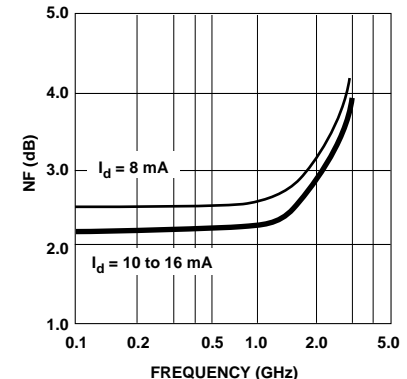
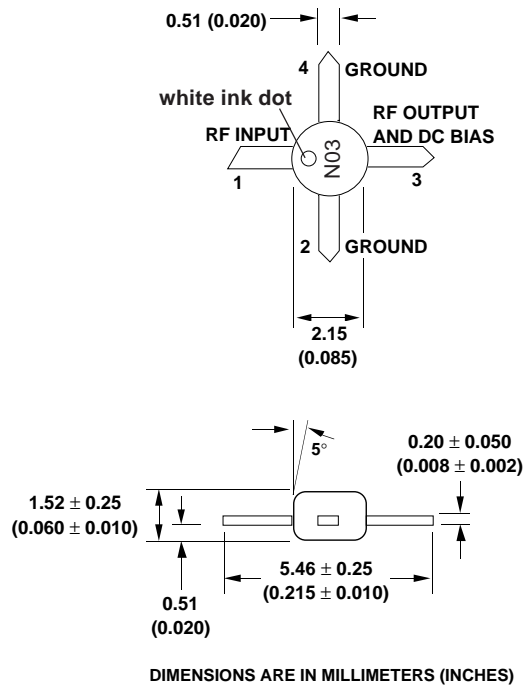

Figure 6. Noise Figure vs. Frequency.

## 84 Plastic Package Dimensions



[www.hp.com/go/rf](http://www.hp.com/go/rf)

For technical assistance or the location of your nearest Hewlett-Packard sales office, distributor or representative call:

**Americas/Canada:** 1-800-235-0312 or 408-654-8675

**Far East/Australasia:** Call your local HP sales office.

**Japan:** (81 3) 3335-8152

**Europe:** Call your local HP sales office.

Data subject to change.  
Copyright © 1998 Hewlett-Packard Co.

Obsoletes 5966-4287E  
Printed in U.S.A. 5967-6160E (6/98)