

# Slotted Optical Switch OPB816Z

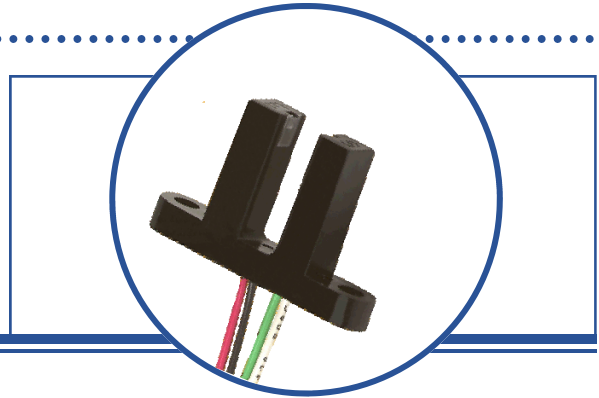

## Features:

- 0.20" (5.1 mm) wide gap, 0.61" (15.5 mm) deep slot
- Wire length 24" (609 mm) minimum, 26 AWG
- Dust protection
- Two mounting tabs



## Description:

The **OPB816Z** slotted switch consists of an infrared emitting diode and an NPN silicon phototransistor mounted in an opaque housing with clear windows for dust protection. Switching of the phototransistor occurs whenever an opaque object passes through the slot.

The **OPB816Z** has an 0.61" (15.5 mm) deep slot allowing for a longer reach of the optical center line from the mounting plane. The phototransistor internal apertures are 0.010" x 0.06" (0.25 mm x 1.52 mm) on the sensor side ("S") and 0.05" x 0.06" (1.27 mm x 1.52 mm) on the emitter side ("E").

Custom electrical, wire and cabling and connectors are available. Contact your local representative or OPTEK for more information.

## Applications:

- Non-contact object sensing
- Assembly line automation
- Machine automation
- Equipment security
- Machine safety

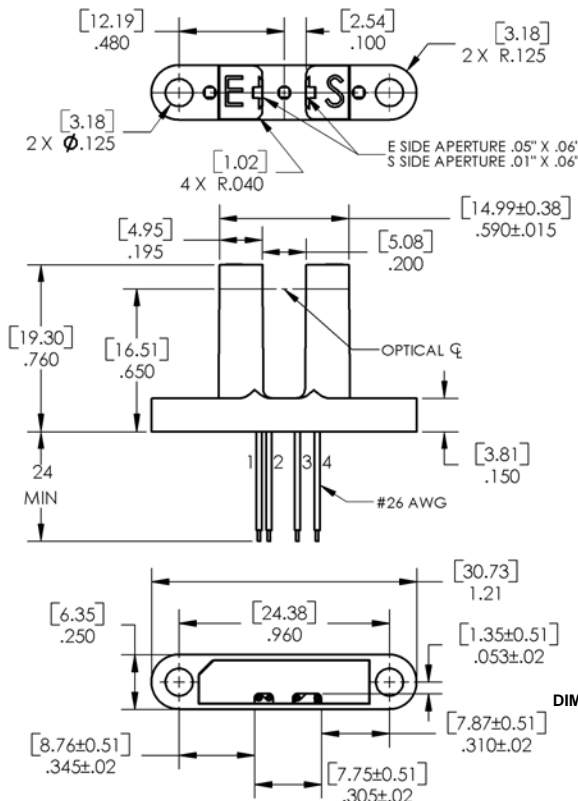
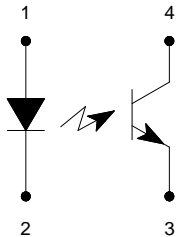

Ordering Information	
Part Number	Description
OPB816Z	Slotted switch

Color/Pin #	Description
Red	Anode
Black	Cathode
Green	Emitter
White	Collector



RoHS

OPTEK reserves the right to make changes at any time in order to improve design and to supply the best product possible.

**Absolute Maximum Ratings** ( $T_A=25^{\circ}\text{C}$  unless otherwise noted)

Storage & Operating Temperature Range	-40°C to +85° C
Lead Soldering Temperature [1/16 inch (1.6mm) from the case for 5 sec. with soldering iron] <sup>(1)</sup>	260° C

**Input Diode** (see OP140 for additional information)

Forward DC Current	50 mA
Peak Forward Current (1 $\mu\text{s}$ pulse width, 300 pps)	3 A
Reverse DC Voltage	2 V
Power Dissipation <sup>(2)</sup>	100 mW

**Output Phototransistor** (See OP552 for additional information)

Collector-Emitter Voltage	30 V
Emitter-Collector Voltage	5 V
Collector DC Current	30 mA
Power Dissipation <sup>(2)</sup>	100 mW

**Electrical Characteristics** ( $T_A = 25^{\circ}\text{C}$  unless otherwise noted)

SYMBOL	PARAMETER	MIN	TYP	MAX	UNITS	TEST CONDITIONS
--------	-----------	-----	-----	-----	-------	-----------------

**Input Diode** (see OP140 for additional information)

$V_F$	Forward Voltage	-	-	1.8	V	$I_F = 20 \text{ mA}$
$I_R$	Reverse Current	-	-	100	$\mu\text{A}$	$V_R = 2 \text{ V}$

**Output Phototransistor** (see OP552 for additional information)

$V_{(BR)(CEO)}$	Collector-Emitter Breakdown Voltage	30	-	-	V	$I_C = 1 \text{ mA}, I_F = 0, E_E = 0$
$V_{(BR)(ECO)}$	Emitter-Collector Breakdown Voltage	5	-	-	V	$I_E = 100 \mu\text{A}, I_F = 0, E_E = 0$
$I_{CEO}$	Collector-Emitter Leakage Current	-	-	100	nA	$V_{CE} = 10 \text{ V}, I_F = 0, E_E = 0$

**Coupled**

$I_{C(ON)}$	On-State Collector Current	1.0	-	10.0	mA	$V_{CE} = 5 \text{ V}, I_F = 20 \text{ mA}$
$V_{CE(SAT)}$	Collector-Emitter	-	-	0.4	V	$I_C = 100 \mu\text{A}, I_F = 20 \text{ mA}$

Notes:

- (1) RMA flux is recommended. Duration can be extended to 10 seconds maximum when flow soldering.
- (2) Derate linearly 1.67 mW/°C above 25° C.
- (3) All parameters are tested using pulse techniques.
- (4) Methanol or isopropanol are recommended as cleaning agents. Plastic housing is soluble in chlorinated hydrocarbons and ketones.
- (5) Clear dust protection over emitter and sensor apertures.

OPTEK reserves the right to make changes at any time in order to improve design and to supply the best product possible.

**OPB816Z - Flag Next to Emitter**

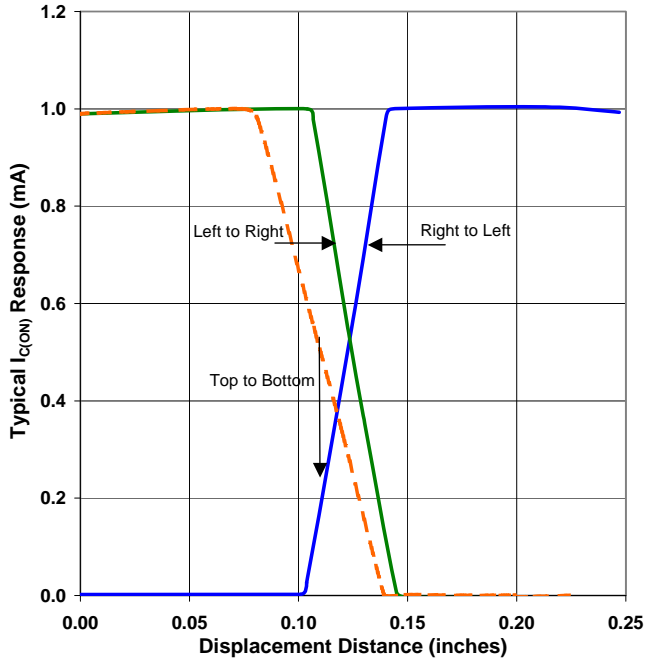

**OPB816Z - Flag Next to Sensor**

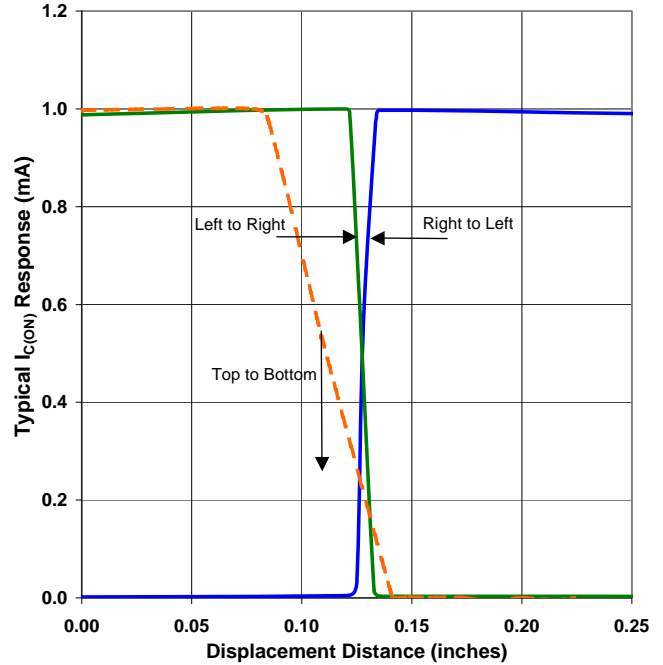

**OPB816Z - Flag in Middle of Slot**

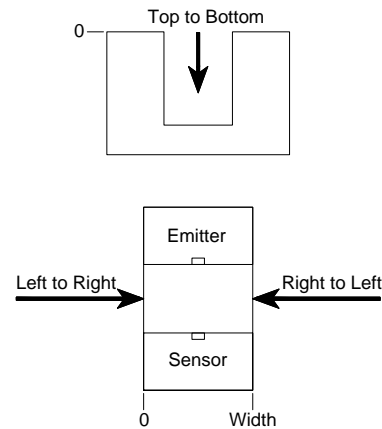
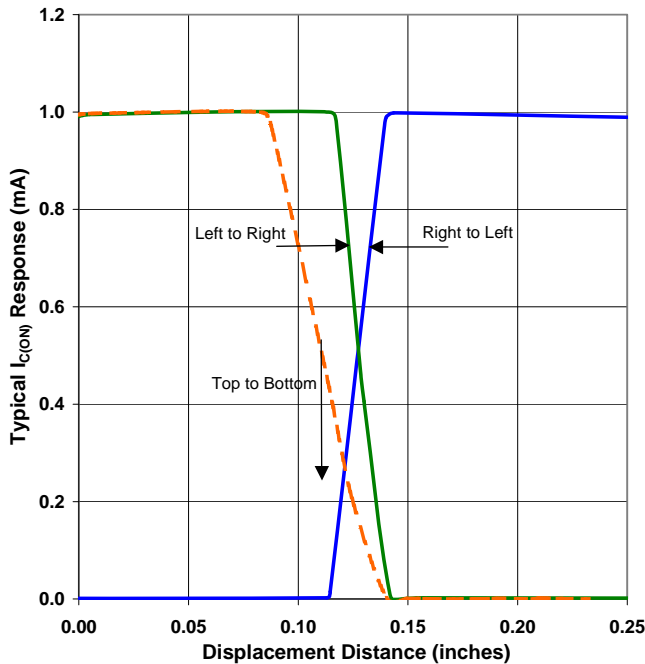

OPTEK reserves the right to make changes at any time in order to improve design and to supply the best product possible.

# Mouser Electronics

Authorized Distributor

Click to View Pricing, Inventory, Delivery & Lifecycle Information:

[TT electronics:](#)

[OPB816Z](#)