

TOSHIBA BIPOLAR LINEAR INTEGRATED CIRCUIT SILICON MONOLITHIC

TC9307AF-008, TC9307AF-018, TC9307AF-019

SINGLECHIP DTS MICRO CONTROLLER (DTS-12)

The TC9307AF-008/-018/-019 are digital tuning system optimum for such portable audio equipment as radio with a cassette tape recorder, and is provided with 5 bands of TV (VHF, UHF)/FM/SW/MW/LW and compatible with worldwide destinations.

FEATURES

○ RECEIVING FREQUENCY BAND

AREA	CODE			STEP JAMPER	BAND	RECEIVING FREQUENCY [Hz]	STEP [Hz]	REFERENCE FREQUENCY [Hz]	INTERMEDIATE FREQUENCY [Hz]
	E0	E1	E2						
USA (1)	0	0	0	—	FM	87.5~ 107.9M	200k	25k	+ 10.7M
				0	MW	530~ 1710k	10k	5k	+ 450k
				1		531~ 1602k	9k	3k	
USA (2)	0	0	1	—	FM	87.5~ 108.0M	100k	25k	+ 10.7M
				0	MW	530~ 1710k	10k	5k	+ 450k
				1		531~ 1602k	9k	3k	
GENERAL (1)	0	1	0	0 / 1	FM	87.50~108.00M	100k / 50k	25k	+ 10.7M
				0	MW	530~ 1610k	10k	5k	+ 450k
				1		531~ 1602k	9k	3k	
				—	LW	146~ 281k	1k	1k	+ 450k
				—	SW-A	5.95~ 15.6M	5k	5k	+ 450k
EUROPE	0	1	1	0 / 1	FM	87.50~108.00M	100k / 50k	25k	+ 10.7M
				0	MW	530~ 1610k	10k	5k	+ 450k
				1		531~ 1602k	9k	3k	
				—	LW	146~ 281k	1k	1k	+ 450k
MIDDLE EAST	1	0	0	0 / 1	FM	87.50~108.00M	100k / 50k	25k	+ 10.7M
				0	MW	530~ 1610k	10k	5k	+ 450k
				1		531~ 1602k	9k	3k	
				—	SW ₁	2.3~ 6.2M	5k	5k	+ 450k
				—	SW ₂	7.1~ 21.85M			
GENERAL (2)	1	0	1	0 / 1	FM	87.50~108.00M	100k / 50k	25k	+ 10.7M
				0	MW	530~ 1610k	10k	5k	+ 450k
				1		531~ 1602k	9k	3k	
				—	LW	146~ 281k	1k	1k	+ 450k
				—	SW-B	3.8~ 12.5M	5k	5k	+ 450k
CANADA AUSTRALIA	1	1	0	—	FM	87.50~ 10.80M	100k	25k	+ 10.7M
				0	MW	530~ 1610k	10k	5k	+ 450k
				1		531~ 1602k	9k	3k	

980910EBA2

● TOSHIBA is continually working to improve the quality and the reliability of its products. Nevertheless, semiconductor devices in general can malfunction or fail due to their inherent electrical sensitivity and vulnerability to physical stress. It is the responsibility of the buyer, when utilizing TOSHIBA products, to observe standards of safety, and to avoid situations in which a malfunction or failure of a TOSHIBA product could cause loss of human life, bodily injury or damage to property. In developing your designs, please ensure that TOSHIBA products are used within specified operating ranges as set forth in the most recent products specifications. Also, please keep in mind the precautions and conditions set forth in the TOSHIBA Semiconductor Reliability Handbook.

AREA	CODE			STEP JAMPER	BAND	RECEIVING FREQUENCY [Hz]	STEP [Hz]	REFERENCE FREQUENCY [Hz]	INTERMEDIATE FREQUENCY [Hz]
	E0	E1	E2						
JAPAN	1	1	1	—	TV	1~ 12ch 13~ 62ch	1ch	1-3 (25k) 12.5k	- 10.7M
				—	FM	76.0~ 90.0M	100k	25k	- 10.7M
				—	MW	531~ 1629k	9k	3k	+ 450k

FUNCTIONAL OUTLINE

- Tuning function
 - Manual Up/Down Tuning
 - It is selectable for tuning system auto-up tuning (seek system) or semi-auto memory tuning.
 - IF count system auto stop function
 - Auto tuning in SW band is the meter band scan system.
 - Memory scan tuning
 - Band changeover can be selected of push switch and lock switch.
- Clock function
 - 12-hour/24-hour clock (set up by destination)
 - ON/OFF timer by time set system
 - Sleep timer (90 min.)
- Difference from -008 function

-018	-019
<ul style="list-style-type: none"> ● During memory scan mode, when pushing the [Memory Scan] key, memory scan is stopped at the channel. ● During manual tuning mode, when pushing [UP]/[DOWN] key, it outputs mute signal. 	<ul style="list-style-type: none"> ● During memory scan mode, when pushing the [Memory Scan] key, memory scan is stopped at the channel. ● It can uses non-clock function.

980910EBA2'

● The products described in this document are subject to the foreign exchange and foreign trade laws.
 ● The information contained herein is presented only as a guide for the applications of our products. No responsibility is assumed by TOSHIBA CORPORATION for any infringements of intellectual property or other rights of the third parties which may result from its use. No license is granted by implication or otherwise under any intellectual property or other rights of TOSHIBA CORPORATION or others.
 ● The information contained herein is subject to change without notice.

TC9307AF-008 Layout-1 (except for JAPAN, U.S.A area)

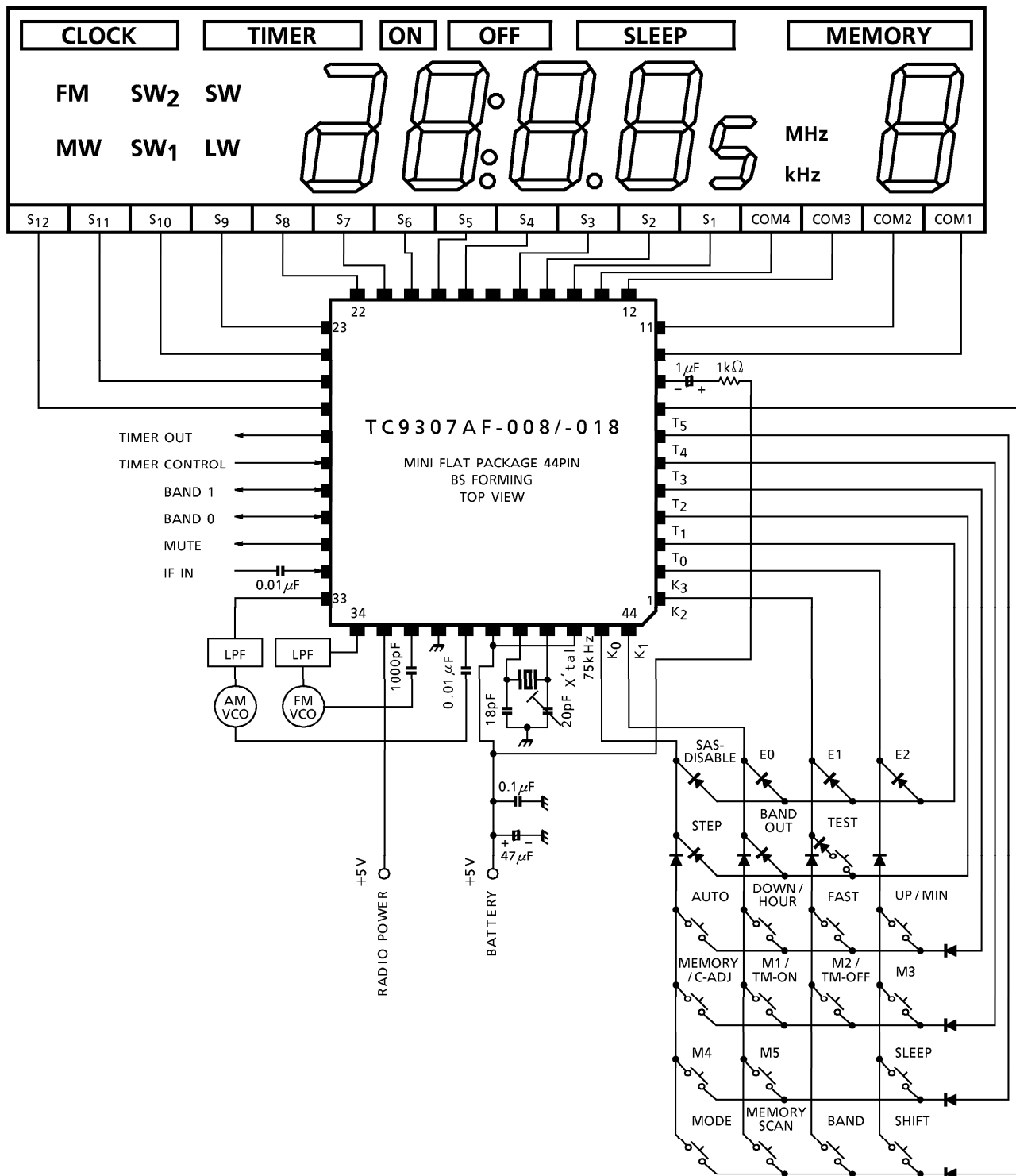

TC9307AF-019 Layout-3 (except for JAPAN, U.S.A area)

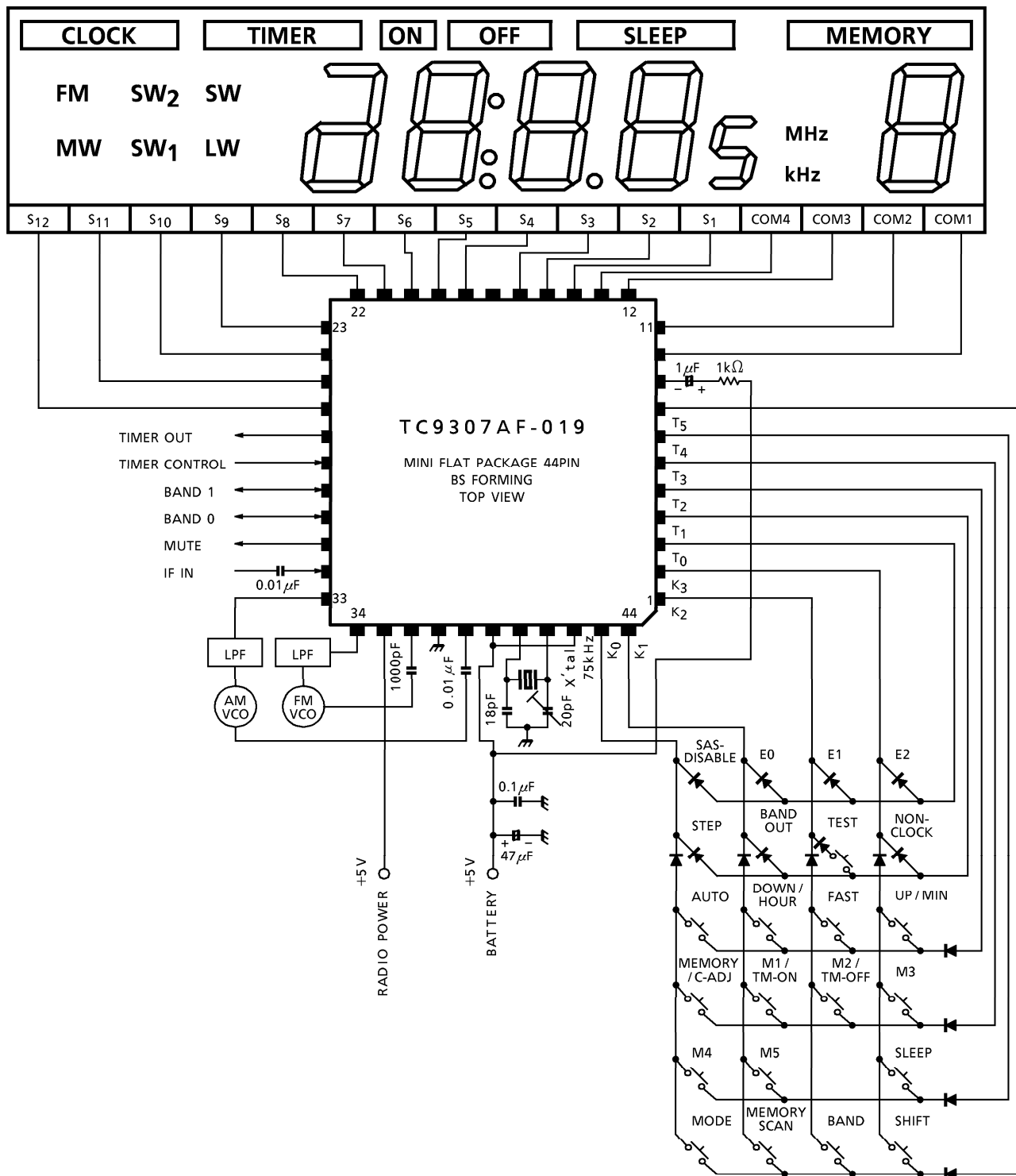

TC9307AF-019 Layout-4 (JAPAN area)

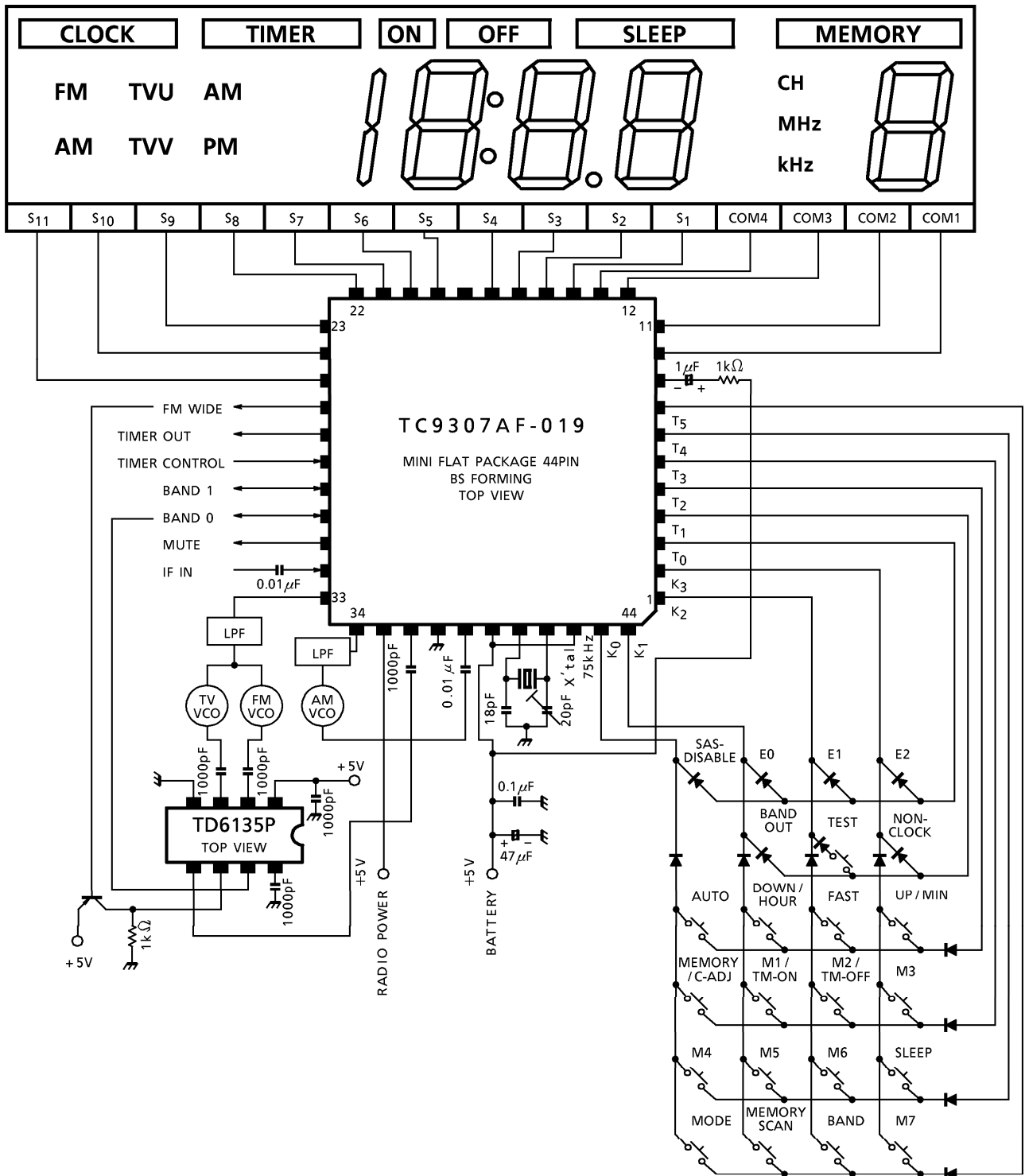

Key Map

TC9307AF-008 / -018 (Japanese Specification Only)

	T ₀	T ₁	T ₂	T ₃	T ₄	T ₅
K ₃	E2		UP / MIN	M3	SLEEP	M7 / SHIFT
K ₂	E1	TEST	FAST	M2 / TIMER-OFF	M6 / -	BAND
K ₁	E0	BAND OUT	DOWN / HOUR	M1 / TIMER-ON	M5	MEMORY SCAN
K ₀	SAM disable	STEP	AUTO	MEMORY	M4	MODE

TC9307AF-008 / -018 (Overseas Specification)

	T ₀	T ₁	T ₂	T ₃	T ₄	T ₅
K ₃	E2		UP / MIN	M3	SLEEP	SHIFT
K ₂	E1	TEST	FAST	M2 / TIMER-OFF		BAND
K ₁	E0	BAND OUT	DOWN / HOUR	M1 / TIMER-ON	M5	MEMORY SCAN
K ₀	SAM disable	STEP	AUTO	MEMORY	M4	MODE

TC9307AF-019 (Japanese Specification Only)

	T ₀	T ₁	T ₂	T ₃	T ₄	T ₅
K ₃	E2	NON- CLOCK	UP / MIN	M3	SLEEP	M7 / SHIFT
K ₂	E1	TEST	FAST	M2 / TIMER-OFF	M6 / -	BAND
K ₁	E0	BAND OUT	DOWN / HOUR	M1 / TIMER-ON	M5	MEMORY SCAN
K ₀	SAM disable	STEP	AUTO	MEMORY	M4	MODE

TC9307AF-019 (Overseas Specification)

	T ₀	T ₁	T ₂	T ₃	T ₄	T ₅
K ₃	E2	NON- CLOCK	UP / MIN	M3	SLEEP	SHIFT
K ₂	E1	TEST	FAST	M2 / TIMER-OFF		BAND
K ₁	E0	BAND OUT	DOWN / HOUR	M1 / TIMER-ON	M5	MEMORY SCAN
K ₀	SAM disable	STEP	AUTO	MEMORY	M4	MODE

* Shown in  denotes tact switch and others show diode jumper.

(Note) When used TEST key, connect a diode with key.

LCD Map (24-hour clock specification-correspond to layout-1 and -3)

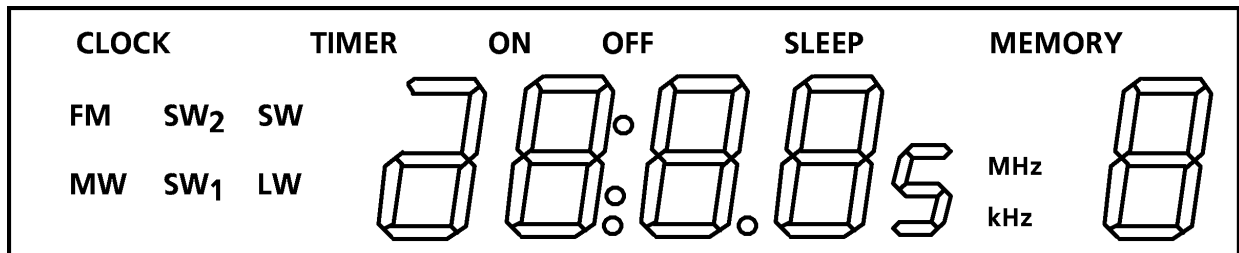

SYMBOL	PIN No.	SEGMENT NAME				FUNCTION
		COMMON 1	COMMON 2	COMMON 3	COMMON 4	
S12	26	5a	FM FM-dot	kHz	MHz	21.845MHz
S11	25	SW-dot	:	SW2	CLOCK	
S10	24	MW	SW1	LW	SW	1.845MHz
S9	23	1c	1a	1b	TIMER	
S8	22	2d	2e	2f	ON	2.845MHz
S7	21	2c	2g	2b	2a	
S6	20	3d	3e	3f	OFF	21.845MHz
S5	19	3c	3g	3b	3a	
S4	18	4d	4e	4f	SLEEP	21.845MHz
S3	16	4c	4g	4b	4a	
S2	15	6d	6e	6f	MEMORY	PRESET CH
S1	14	6c	6g	6b	6a	
COM4	13	----	----	----	COM4	Common 4
COM3	12	----	----	COM3	----	Common 3
COM2	11	----	COM2	----	----	Common 2
COM1	10	COM1	----	----	----	Common 1

LCD Map (12-hour clock specification-correspond to layout-2 and -4)

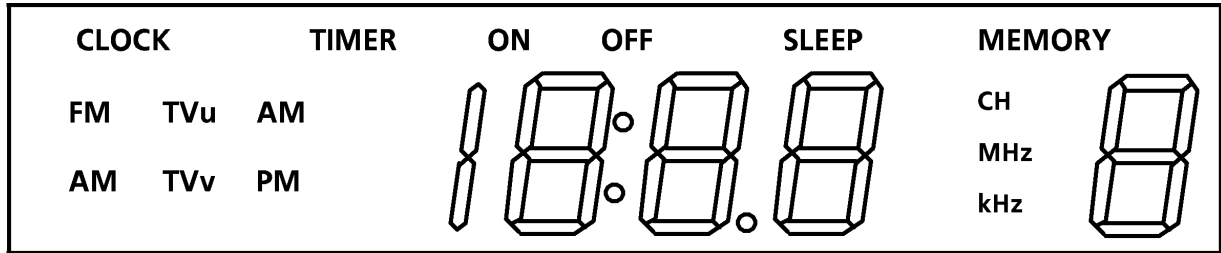

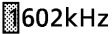
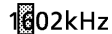
SYMBOL	PIN No.	SEGMENT NAME				FUNCTION
		COMMON 1	COMMON 2	COMMON 3	COMMON 4	
(S ₁₂)	(26)	----	----	----	----	S ₁₂ is used for I/O port P20.
S ₁₁	25	AM kHz	FM dot MHz	CH	CLOCK	
S ₁₀	24	AM	TV v	TV u	----	
S ₉	23	PM	:	1b	TIMER	
S ₈	22	2d	2e	2f	ON	
S ₇	21	2c	2g	2b	2a	
S ₆	20	3d	3e	3f	OFF	1602kHz
S ₅	19	3c	3g	3b	3a	
S ₄	18	4d	4e	4f	SLEEP	1602kHz
S ₃	16	4c	4g	4b	4a	
S ₂	15	5d	5e	5f	MEMORY	PRESET CH
S ₁	14	5c	5g	5b	5a	
COM4	13	----	----	----	COM4	Common 4
COM3	12	----	----	COM3	----	Common 3
COM2	11	----	COM2	----	----	Common 2
COM1	10	COM1	----	----	----	Common 1

I/O PORT

PORT	No.	NAME	I/O	FUNCTION	ACTIVE	INIT.																					
P10	30	B0	IN	Without [band out] jumper	—	—																					
				<table border="1"> <thead> <tr> <th>B1 B0</th> <th>JPN</th> <th>USA CAN.</th> <th>GEN. SW-A</th> <th>MIDDLE & NEAR EAST</th> <th>EURO</th> <th>GEN. SW-B</th> </tr> </thead> <tbody> <tr> <td>0 0</td> <td>TV-v</td> <td>FM</td> <td>FM</td> <td>FM</td> <td>FM</td> <td>FM</td> </tr> </tbody> </table>			B1 B0	JPN	USA CAN.	GEN. SW-A	MIDDLE & NEAR EAST	EURO	GEN. SW-B	0 0	TV-v	FM	FM	FM	FM	FM							
B1 B0	JPN	USA CAN.	GEN. SW-A	MIDDLE & NEAR EAST	EURO	GEN. SW-B																					
0 0	TV-v	FM	FM	FM	FM	FM																					
P11	29	B1	IN	<table border="1"> <tbody> <tr> <td>0 1</td> <td>TV-u</td> <td>FM</td> <td>LW</td> <td>SW₁</td> <td>LW</td> <td>LW</td> </tr> <tr> <td>1 0</td> <td>FM</td> <td>MW</td> <td>MW</td> <td>MW</td> <td>MW</td> <td>MW</td> </tr> <tr> <td>1 1</td> <td>AM</td> <td>FM</td> <td>SW-A</td> <td>SW₂</td> <td>FM</td> <td>SW-B</td> </tr> </tbody> </table>	0 1	TV-u	FM	LW	SW ₁	LW	LW	1 0	FM	MW	MW	MW	MW	MW	1 1	AM	FM	SW-A	SW ₂	FM	SW-B	—	—
				0 1	TV-u	FM	LW	SW ₁	LW	LW																	
1 0	FM	MW	MW	MW	MW	MW																					
1 1	AM	FM	SW-A	SW ₂	FM	SW-B																					
P10	30	B0	OUT	With [band out] jumper	—	—																					
				<table border="1"> <thead> <tr> <th>B1 B0</th> <th>JPN</th> <th>USA CAN.</th> <th>GEN. SW-A</th> <th>MIDDLE & NEAR EAST</th> <th>EURO</th> <th>GEN. SW-B</th> </tr> </thead> <tbody> <tr> <td>0 0</td> <td>TV-v</td> <td>FM</td> <td>FM</td> <td>FM</td> <td>FM</td> <td>FM</td> </tr> </tbody> </table>			B1 B0	JPN	USA CAN.	GEN. SW-A	MIDDLE & NEAR EAST	EURO	GEN. SW-B	0 0	TV-v	FM	FM	FM	FM	FM							
B1 B0	JPN	USA CAN.	GEN. SW-A	MIDDLE & NEAR EAST	EURO	GEN. SW-B																					
0 0	TV-v	FM	FM	FM	FM	FM																					
P11	29	B1	OUT	<table border="1"> <tbody> <tr> <td>0 1</td> <td>TV-u</td> <td>—</td> <td>LW</td> <td>SW₁</td> <td>LW</td> <td>LW</td> </tr> <tr> <td>1 0</td> <td>FM</td> <td>MW</td> <td>MW</td> <td>MW</td> <td>MW</td> <td>MW</td> </tr> <tr> <td>1 1</td> <td>AM</td> <td>—</td> <td>SW-A</td> <td>SW₂</td> <td>—</td> <td>SW-B</td> </tr> </tbody> </table>	0 1	TV-u	—	LW	SW ₁	LW	LW	1 0	FM	MW	MW	MW	MW	MW	1 1	AM	—	SW-A	SW ₂	—	SW-B	—	—
				0 1	TV-u	—	LW	SW ₁	LW	LW																	
1 0	FM	MW	MW	MW	MW	MW																					
1 1	AM	—	SW-A	SW ₂	—	SW-B																					
P12	28	TIMER CONT.	IN	Timer control input : Timer operation at "L" and non-operation at "H" level.	L	—																					
P13	27	TIMER OUT	OUT	Timer control output : This port is put at "H" level during the timer operation and sleep operation.	H	L																					
P20	26	FM WIDE	OUT	TV receiving prescaler control output. When receiving TV VHF (4-12ch) and UHF, this port is put at "L" level. When using as the 24-hour clock specification, this pin is switched to LCD segment.	H	—																					
MUTE	31	MUTE	OUT	Muting output	H	L																					

PUSH KEY

SYMBOL	FUNCTIONAL DESCRIPTION
AUTO	Semi auto memory function if SAM disable jumper is not available. Auto up tuning function if SAM disable jumper is available.
UP / MIN	Frequency up. Continuous tuning mode results if the key is continuously pressed for more than 0.5s. When correcting a time or setting the timer, "MIN" digit is set up.
FAST	Multiple pressing together with UP / DOWN keys accelerates the manual tuning.
DOWN / HOUR	Frequency down. Continuous tuning mode results if the key is continuously pressed for more than 0.5s. When correcting a timer or setting the timer, "HOUR" digit is set up.
MEMORY	When indicating frequency, puts the system in the preset memory write mode. When indicating clock, puts the system in the clock correction mode.
BAND	Cyclically changes bands by push key. (when BAND OUT is connected diode jumper.)
M1 / TIMER-ON	When indicating frequency, this key is used for the preset memory call and write. When indicating a time, puts the system in the timer ON time set-up mode.
M2 / TIMER-OFF	When indicating frequency, this key is used for the preset memory call and write. When indicating a time, puts the system in the timer OFF time set-up mode.
M3~M5, (M6)	This key is for the preset memory call and write.
SHIFT / (M7)	If the preset memory has channels up to 10, push this key and then, push M1~M5 keys for M6~M10 key call and write.
SLEEP	Sets up the sleep timer.
MODE	Switches the frequency indication and clock indication.
MEMORY SCAN	Calls and receives the preset memory in order.
TEST	Except TEST key and FAST key is started by depressing all indications on LCD are kept ON. Further, this key is capable of checking the timer and sleep functions by accelerating the clock.

FUNCTION (Diode jumper)

SYMBOL	FUNCTION DESCRIPTION																																											
E0, E1, E2	<p>Sets up a destination</p> <table border="1" data-bbox="395 450 1067 810"> <thead> <tr> <th colspan="3">DIODE</th> <th rowspan="2">DESTINATION</th> <th rowspan="2">CLOCK FUNCTION</th> </tr> <tr> <th>E0</th> <th>E1</th> <th>E2</th> </tr> </thead> <tbody> <tr> <td></td> <td></td> <td></td> <td>U.S.A. (1)</td> <td rowspan="2">12-hour clock</td> </tr> <tr> <td></td> <td></td> <td>○</td> <td>U.S.A. (2)</td> </tr> <tr> <td></td> <td>○</td> <td></td> <td>General (1)</td> <td rowspan="6">24-hour clock</td> </tr> <tr> <td></td> <td>○</td> <td>○</td> <td>Europe</td> </tr> <tr> <td>○</td> <td></td> <td></td> <td>Middle & Near East</td> </tr> <tr> <td>○</td> <td></td> <td>○</td> <td>General (2)</td> </tr> <tr> <td>○</td> <td>○</td> <td></td> <td>Canada, Australia</td> </tr> <tr> <td>○</td> <td>○</td> <td>○</td> <td>Japan</td> <td>12-hour clock</td> </tr> </tbody> </table> <p>○ : Diode is available.</p>	DIODE			DESTINATION	CLOCK FUNCTION	E0	E1	E2				U.S.A. (1)	12-hour clock			○	U.S.A. (2)		○		General (1)	24-hour clock		○	○	Europe	○			Middle & Near East	○		○	General (2)	○	○		Canada, Australia	○	○	○	Japan	12-hour clock
DIODE			DESTINATION	CLOCK FUNCTION																																								
E0	E1	E2																																										
			U.S.A. (1)	12-hour clock																																								
		○	U.S.A. (2)																																									
	○		General (1)	24-hour clock																																								
	○	○	Europe																																									
○			Middle & Near East																																									
○		○	General (2)																																									
○	○		Canada, Australia																																									
○	○	○	Japan		12-hour clock																																							
SAM disable	<p>Select whether [AUTO] key is to be used as the auto-up tuning or the semi auto memory. With the jumper : Auto up tuning operation. Without the jumper : Semi auto memory operation.</p>																																											
STEP	<p>Except the specification for Japan (E0=0, E1=0, E2=0), selects AM/FM step. With the jumper : MW 9k / FM 50k step Without the jumper : MW 10k / FM 100k step However, FM band for U.S.A., Canada and Australia (12-hour clock) is fixed at 200kHz step (U.S.A.1), 100kHz step (U.S.A.2).</p>																																											
BAND OUT	<p>With diode jumper : Cyclically changes bands by BAND key. B0, B1 is band output. Without diode jumper : Changed Bands with B0, B1 input.</p>																																											

The diode jumper is read when a radio is turned ON or there is a key input.

BAND SWITCHING

1. Principal function

Bands are switched.

2. Input/Output Port to be used.

B0, B1, BAND OUT, BAND

3. Function

BAND OUT jumper is not available.

a. Selects receiving bands according to combination of the band input ports B0 and B1.

b. Bands selected according to destination are as follows :

(1) Japan (E0, E1, E2 = 1, 1, 1)

INPUT PORT		BAND	FREQUENCY RANGE (Hz)	OUTPUT PORT
P11	P10			P20
1	1	AM	531k-1629k	1
1	0	FM	76M-90M	1
0	0	TV-v	1ch-3ch	1
			4ch-12ch	0
0	1	TV-u	13ch-62ch	0

(Note) For frequency division ratio of FM/TV-v prescaler, 1/1 is used for TV (1-3ch) as in FM as the front end circuit is designed for FM band. (N2 input of the prescaler is controlled by control signal of the output port P20.)

(2) Overseas (When E0, E1 and E2 are other than the specification for shipment to Japan)

INPUT PORT		U.S.A. CANADA, AUSTRALIA (2 BAND)	EUROPE (3 BAND)	MIDDLE & NEAR EAST (4 BAND)	GENERAL (1) (4 BAND)	GENERAL (2) (4 BAND)
P11	P10					
0	0	FM	FM	FM	FM	FM
0	1	(FM)	LW	SW ₁	LW	LW
1	0	AM	MW	MW	MW	MW
1	1	(FM)	(FM)	SW ₂	SW-A	SW-B

BAND OUT : without diode jumper

a. Cyclically changed bands by BAND key.

The band construction is as shown below.

Japan Area

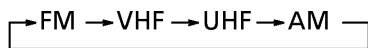

Europe Area



Other

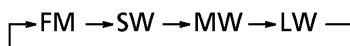

U.S.A., Canada, Australia Area

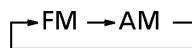

Middle & Near East Area

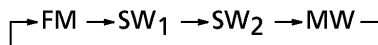

MANUAL TUNING

1. Principal function

1 push / 1 step tuning by [UP] / [DOWN] key.

2. Key to be used

UP, DOWN, MODE, FAST

3. Functions

a. Use by switching a mode to the frequency mode.

b. 1 push / 1 step tuning by [UP] / [DOWN] key.

When receiving TV, the step tuning is made in such a manner as 1ch, 2ch...ch.

c. Tuning is continuously carried out when [UP] / [DOWN] key is kept pushed continuously for more than 500ms and it stops when the key is released.

d. When [FAST] key is kept pushed jointly with [UP] / [DOWN] key, the high speed continuous tuning results (except TV-v band).

During the high speed continuous tuning, the continuous tuning up / down step frequency normally changes as follows :

BAND	SCAN TIME	STEP FREQUENCY	
		NORMAL	ACCELERATED
FM	100ms / STEP	100kHz	200kHz
		50kHz	200kHz
MW	200ms / STEP	9kHz	18kHz
		10kHz	20kHz
LW	200ms / STEP	1kHz	2kHz
SW	200ms / STEP	5kHz	100kHz
VHF	400ms / STEP	1ch	1ch
UHF	200ms / STEP	1ch	2ch

However, in SW band, if frequency below 0.1MHz is not zero when [UP] / [DOWN] key and [FAST] are pushed, after the up / down tuning as follows, the up / down tuning at 100kHz is carried out.

In case of 16.555MHz

[UP] + [FAST]

16.555MHz → 16.600MHz → 16.700MHz →

[DOWN] + [FAST]

16.555MHz → 16.500MHz → 16.400MHz →

AUTO SEARCH TUNING

1. Principal function

Auto up tuning by [AUTO] key

2. Keys to be used

MODE, AUTO

3. Functions

- a. Turn SAM disable jumper "ON". (Connect a diode.)
- b. Use in the frequency mode by [MODE] key.
- c. When [AUTO] key is pushed, the auto up tuning starts from the frequency being indicated.
- d. The auto up tuning speed is the same as the continuous tuning speed.
However, in the SW band, the inside of the meter band only is canned at 5kHz per step.
- e. In the following cases, the auto up tuning is stopped :
 - When any key other than [AUTO] key is operated.
 - When a band is being switched.
 - When STOP signal is detected by IF counter input.
- f. When the upper limit frequency is reached, the tuning shifts toward the lower limit frequency and after stopping the auto up tuning for 500ms, the tuning is resumed.
Further, in the meter bands of the SW band, the auto up tuning stops for 500ms at the first step after shifted to next meter band.
- g. If STOP signal is detected by IF counter input, the tuning stops at that frequency.
- h. Meter band frequencies in SW band are as follows :

	FREQUENCY	STEP
SW ₁	2.300~ 2.495	5kHz
	3.200~ 3.400	
	3.900~ 4.000	
	4.750~ 5.060	
	5.950~ 6.200	
SW ₂	7.100~ 7.300	5kHz
	9.500~ 9.900	
	11.650~12.050	
	13.600~13.800	
	15.100~15.600	
	17.550~17.900	
	21.450~21.850	

	FREQUENCY	STEP
SW-A	5.950~ 6.200	5kHz
	7.100~ 7.300	
	9.500~ 9.900	
	11.650~12.050	
	13.600~13.800	
	15.100~15.600	

	FREQUENCY	STEP
SW-B	3.900~ 4.000	5kHz
	4.750~ 5.060	
	5.950~ 6.200	
	7.100~ 7.300	
	9.500~ 9.900	
	11.650~12.050	

SEMI-AUTO MEMORY TUNING

1. Principal function

Semi-auto memory tuning with [AUTO] key.

2. Keys to be used

MODE, AUTO

3. Functions

- a. Set SAM disable jumper to "OFF". (without diode)
- b. Pushing [AUTO] key starts the scan tuning from the lower limit frequency.
- c. If STOP signal is detected by IF counter input, the scan tuning is stopped temporarily for 5s. and then, is continuously carried out.
- d. At this time, when [MEMORY] key is pushed, write into the preset memory M1 is automatically carried out.
The write is made in order of M2, M3 ... to max. preset channel by repeating this operation.
When the write is made up to max. preset channel, the semi-auto memory tuning is stopped at that frequency.
- e. If all the preset memory channels are not filled by the semi-auto memory tuning, the scanning is made twice from the lower limit frequency to the upper limit frequency and reading out a frequency of the lastly preset memory channel, the tuning is stopped.
(If made twice and the tuning is stopped at the upper limit frequency.)

PRESET MEMORY

1. Principal function

The number of preset memories set up by destination can be realized.

2. Keys to be used

MEMORY, AUTO (when SAM disable is "OFF".)

- M1~M7 : Specification for Japan
M1~M5 : Specification for Middle & Near East
M1~M5, SHIFT (M6~M10) : Specification for other areas

3. Functions

- a. When [M1]~[M7] keys for the specification for Japan and [M1]~[M5] keys for the specification for the Middle and Near East are pushed, the pushed preset memories are read out.
- b. For the specification for other areas, when [M1]~[M10] keys are pushed, the pushed preset memories are read out.
In this case, [M6]~[M10] keys become effective by pushing [M1]~[M5] keys after pushing [SHIFT] key.
Pushing [SHIFT] key result in the shift mode but no starts indication is made, and the shift mode is released when [SHIFT] key is pushed again.
The shift mode is also released by pushing [MEMORY SCAN] key but is not released by other keys.

- c. When [MEMORY] key is pushed, "MEMORY" indication lights for 4s. and during this period if the preset key is pushed, a frequency (Ch-No. in the TV mode) is written in that preset memory and lighting of "MEMORY" indication ends.
"MEMORY" indication also goes out by other key input than [SHIFT] key and [FAST] key and the write status is cancelled.
- d. Preset number is indicated on LCD but in case of 10CH, "0" is indicated.
- e. Destinations, receiving bands and number of preset memory channels are as follows :

DIODE			FM	MW	TV		LW	SW			DESTINATIONS
E0	E1	E2			VHF	UHF		SW	SW ₁	SW ₂	
			10	10	—	—	—	—	—	—	U.S.A. (1)
		○	10	10	—	—	—	—	—	—	U.S.A. (2)
	○		10	5	—	—	5	5	—	—	General (1)
	○	○	10	5	—	—	5	—	—	—	Europe
○			5	5	—	—	—	—	5	5	Middle & Near East
○		○	10	5	—	—	5	5	—	—	General (2)
○	○		10	10	—	—	—	—	—	—	Canada, Australia
○	○	○	7	7	7	7	—	—	—	—	Japan

○ : Diode is available.

f. Tracking data

Immediately after initialization, the preset memories are set up as shown below.

BAND	M1	M2	M3	M4	M5	AREA / BAND
FM	76.0	83.0	90.0	76.0	76.0	Japan
	87.5	90.1	98.1	106.1	107.9	U.S.A. (1)
	87.5	90.0	98.0	106.0	108.0	Others
VHF	2ch	3ch	4ch	8ch	12ch	Japan
UHF	13ch	23ch	35ch	48ch	62ch	Japan
MW	531	603	999	1404	1629	Japan
	530	600	1000	1400	1710	U.S.A. (1) (2) (9k step)
	531	603	999	1404	1602	Others (9k step)
	530	600	1000	1400	1610	Others (10k step)
LW	146	164	209	263	281	—
SW	5.95	6.50	10.00	14.00	15.60	SW-A
	3.80	5.00	7.00	11.00	12.50	SW-B
	2.30	3.00	4.50	6.00	6.20	SW ₁
	7.10	8.00	14.00	20.00	21.85	SW ₂

* Other preset memory is set to lower data.

MEMORY SCANNING

1. Principal function

All the preset memories are read out at intervals of 5s.

2. Key to be used

MEMORY-SCAN

3. Functions

- a. When [MEMORY-SCAN] key is pushed during the preset memory receiving, from next channel the preset memories are read out at intervals of 5s. and when made a round, the memory scan stops at the channel where the preset memory was previously receiving before the memory-scan.
- b. If [MEMORY-SCAN] key is pushed during the memory-scan, the preset memory currently being indicated is skipped to next preset memory and the memory-scan is continued.
- c. In the following cases, the memory-scan stops :
 - If any other key than [MEMORY-SCAN] key was operated. (Specification for shipment in Japan)
 - If any other key than [MEMORY-SCAN] and [SHIFT] key was operated. (Specification for overseas shipment)
 - If a receiving band was changed.
- d. During the memory-scan, the preset channel number segments flash at 1Hz.

CORRECTION OF CLOCK

1. Principal function

Corrects a current time.

2. Keys to be used

MODE, MEMORY, DOWN, UP

3. Functions

- a. Sets the clock indication with the MODE key.
- b. When the MEMORY key is pushed, a character of "CLOCK" flashes for 10s. and the system is put in the clock correction mode.
When the MEMORY key is pushed again during the flashing the flashing ends and the clock correction mode is released.
- c. When "CLOCK" is flashing, the following corrections can be made :
 - Up key : Correction of minute
(1 min / push. Continuous pushing for more than 0.5s. changes to the speed 1 min / 0.5s.)
 - Down key : Correction of hour
(1 hour / push. Continuous pushing for more than 0.5s. changes to the speed 1 hour / 0.5s.)

- d. If any key other than the above is pushed during correction, the following status result :
- FAST → Does not change.
 - SHIFT → Does not change.
 - M1 → The correction mode is changed to the timer ON time setting mode.
 - M2 → The correction mode is changed to the timer OFF time setting mode.
 - M3~M7 (M3~M5) → The correction mode is released.
 - AUTO → The correction mode is released.
 - MEMORY-SCAN → The correction mode is released.
 - SLEEP → The correction mode is released and the system is placed in the sleep state.
 - MODE → The correction mode is released. (When a radio is ON, the correction mode is released and the frequency is indicated.)
- e. If there is no key input for 10s., the correction mode is released automatically and then, a current time is indicated.
- f. When correcting "MIN.", s. is cleared to "00" if any key input is made.

SLEEP TIMER

1. Principal function

The 90 min. sleep timer can be set.

2. Key to be used

SLEEP

3. Functions

- a. When [SLEEP] key is pushed, the timer out (P13) is put at "H" level, "SLEEP" and a sleep time are indicated on LCD, and a 90 min. sleep time is set up.
Further, if [SLEEP] key is pushed again, the sleep operation is released and the timer out (P13) is put at "L" level.
- b. To change a sleep time, directly push [SLEEP] key continuously for more than 1s. when setting the sleep operation.
A sleep time can be set up at intervals of 0.5s./step like 90, 80, ... 10, 1, 90.
- c. There is no indication for residual sleep time and if there is not [SLEEP] key input for 10s., the system returns to a mode before pushing [SLEEP] key.

- d. If any other key than [SLEEP] key is pushed while "SLEEP" is being indicated, the following status result :
1. In the frequency indication mode :
 - FAST, SHIFT → Remain unchanged.
 - DOWN, UP, MEMORY → Return to the state before [SLEEP] key input.
 - AUTO → Indicates frequency and starts the scanning.
 - Preset memory → Indicates frequency, receives and indicates the pushed preset memory.
 - MODE → The mode changes to the clock indication mode.
 - MEMORY SCAN → Indicates frequency and start the memory-scan.
 2. In the clock indication mode (when a radio is ON)
 - FAST, SHIFT → Remain unchanged.
 - Preset memory → Is changed to the frequency indication mode before [SLEEP] key input, and reads out the push key preset channel.
 - AUTO → Is switches to the frequency indication mode before [SLEEP] key input and starts the scanning.
 - MEMORY, MODE → Return to the state before [SLEEP] key input.
 - MEMORY SCAN → Is changed to the frequency indication mode and starts the memory-scan.
 - UP, DOWN → Is changed to the frequency indication mode.
 3. In the clock mode (when a radio is OFF)
 - FAST, SHIFT → Remain unchanged.
 - Others, → Indicates current time.

TIME SETTING ON TIMER

1. Principal function

Setting of the timer ON/OFF time and timer operation

2. Key to be used

MODE, M1, M2, DOWN, UP

3. Function

- a. Changing the mode to the clock indication mode with [MODE] key, set a time on the timer by the following key operations.
- b. When [M1] key is pushed, "TIMER ON" flashes for 10s. and the timer ON time currently set is indicated.
- c. While "TIMER ON" is flashing, the following corrections can be made :
 - [UP] key ; Correction of minute
(1 min / push. Continuous pushing for more than 0.5s. changes to a speed of 1 min / 0.5s)

- [DOWN] key ; Correction of hour
(1 hour/push. Continuous pushing for more than 0.5s. changes to a speed of 1 hour/0.5s)
The time correction function is automatically released 10s. later from the no key input state and then, a current time is indicated.
- d. When [M2] key is pushed, "TIMER OFF" flashes for 10s. and the timer OFF time is indicated as shown below.
- When the timer ON time was corrected :
The same time the timer ON time.
 - When the timer ON time is not corrected :
The previously set time.
- e. While "TIMER OFF" is flashing, the timer OFF time can be set up.
If there is no key input for 10s., the correct function is automatically released and a current time is indicated.
- f. When the timer control terminal (P12) is changed from "H" to "L" level, the indications on LCD and the time out terminal (P13) become the following state.
- When the timer ON and OFF times are the same :
"TIMER ON" is indicated on LCD.
The timer out terminal is kept at "H" level after the timer ON time.
 - When the timer ON and OFF times are different :
The indication on LCD changes to "TIMER ON OFF" and changes to "TIMER OFF" indication when the timer is turned ON.
Further, after the timer OFF time, it turns to "TIMER ON OFF".
The timer out terminal is kept at "H" level from the timer ON time to the timer OFF time.
- g. If any invalid key is pushed during the time correction, the timer setting mode is automatically released and a current time is indicated.
In this case, the previous data before the invalid key was pushed is held for the timer ON/OFF time setting.
- h. If [SLEEP] key is pushed during the time correction, the timer time setting is released and changes to the sleep mode.
- i. The timer OFF time only can be corrected.
However, if a timer ON time is set after setting a timer OFF time, the timer OFF time becomes the same time as the timer ON time.
- j. When the timer control terminal (P12) is set at "L" level and after the timer out terminal (P13) has become "H" level, the timer out control terminal (P12) is set at "H" level, the timer out terminal (P13) becomes "L" level.
- k. Relationship between sleep operation and timer operation.
- The sleep operation is controlled with the non-lock key "SLEEP" and its control output is output to the timer out terminal (P13).
The timer out terminal (P13) will become "H" level if either SLEEP or Timer is ON.
 - If the timer operation and the sleep operation are overlapped each other, the following state results.

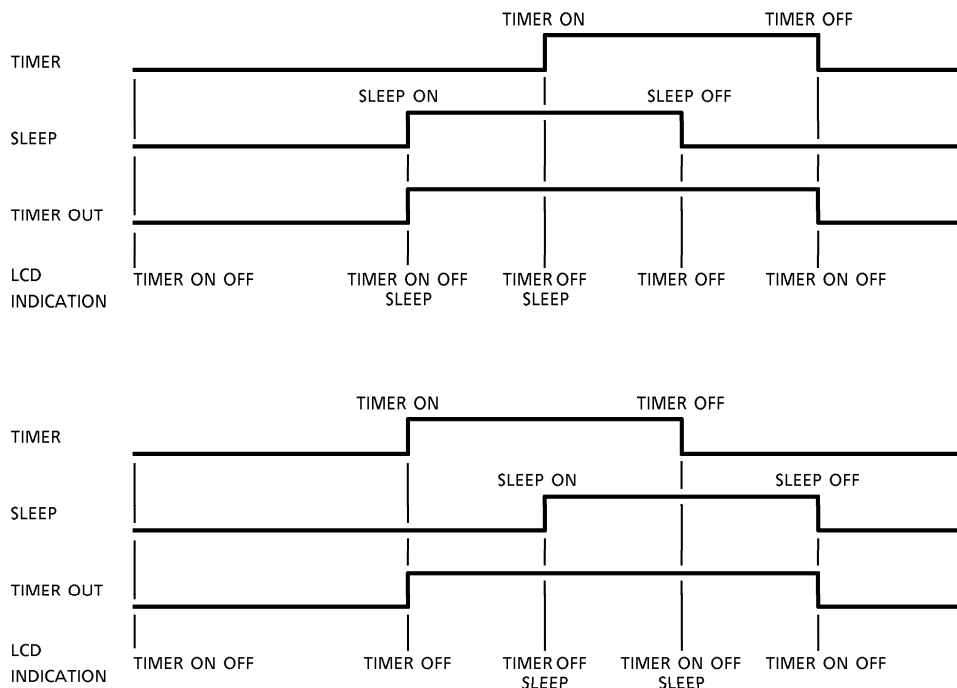

MUTING

1. Principal function

In the following cases, mute signal (H active) is output.

2. Keys to be used

M1~M7, UP, DOWN, FAST, AUTO

3. Functions

a. In the following cases, mute signal is output for 1s. :

- When initializing.
- When switching a receiving band.
- When calling a preset channel.
- When turning a radio OFF or ON (Radio ON/OFF by the timer out (P13) control).
- When reaching the band edge during manual up/down tuning or continuous tuning.
- When manual up/down domestic TV and UHF bands.

- b. In the following case, mute signal is output :
 - During auto up tuning.
- c. In the following cases, no mute signal is output :
 - When manual up/down tuning other than TV/UHF bands. (LW/MW/SW/FM bands)
 - In the clock mode.
 - When operating MEMORY, FAST, MODE or SHIFT key.
 - When writing into a preset channel.
 - When calling the same preset channel.

Mute output timing and PLL data display channel

(Note) PLL : PLL data set timing
 DISP : Display up data timing
 IF : IF count start timing

1. When initializing

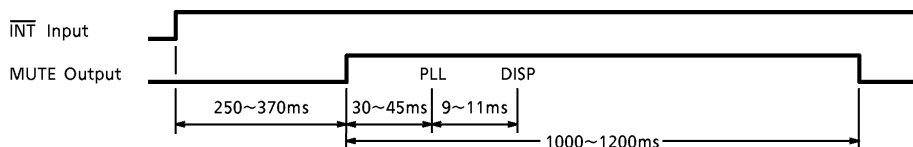

2. When a radio ON/OFF (with clock)

Radio OFF to ON

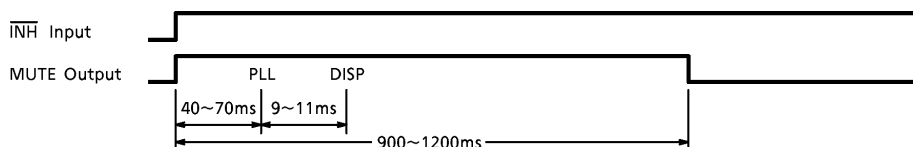

Radio ON to OFF

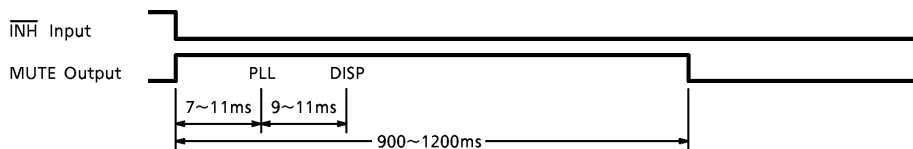

3. When a radio ON/OFF (with clock (only TC9307AF-019 function))

Radio OFF to ON

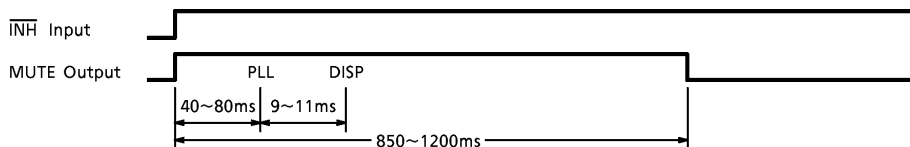

Radio ON to OFF



4. When switching a receiving band

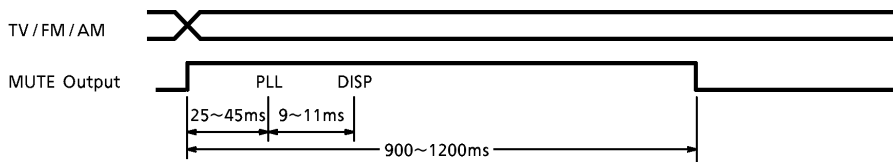

5. When calling a preset memory

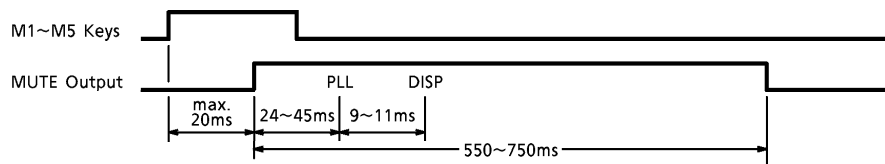

6. When memory scanning

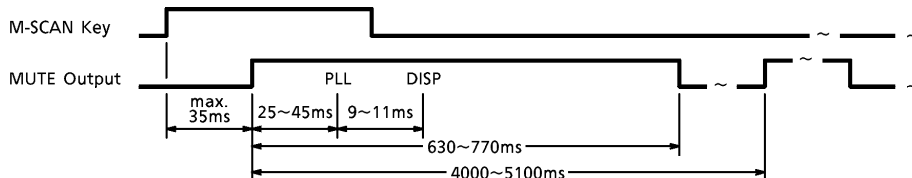

7. Continuous manual band edge timing (Except TV)

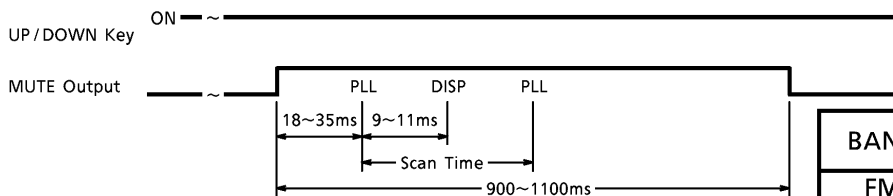

BAND	SCAN TIME [ms]
FM	75~125
MW / LW	175~225
SW	165~235

8. 1 step / 1 push edge (Except TV)

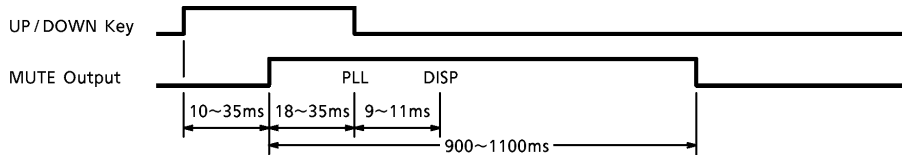

9. TV (VHF, UHF) continuous manual tuning

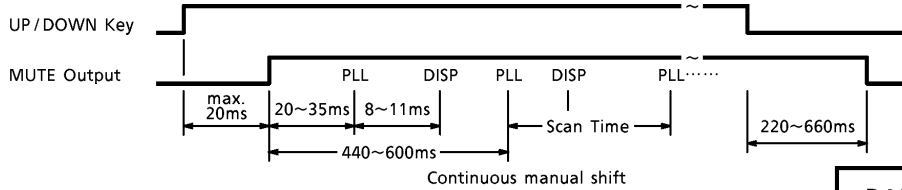

BAND	SCAN TIME [ms]
VHF	370~420
UHF	165~220

10. Auto up tuning

Wide : Count gate time at wide accuracy = 4ms (AM) / 1ms (FM)

Narrow : Count gate time at narrow accuracy = 16ms (AM) / 4ms (FM)

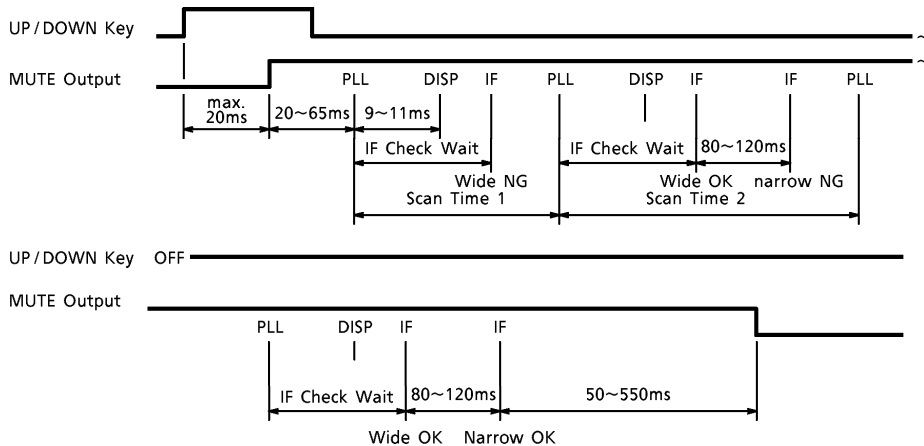

BAND	SCAN TIME 1 [ms]	SCAN TIME 2 [ms]	IF CHECK WAIT [ms]
VHF	380~420	485~520	350~380
UHF	180~210	280~310	145~180
FM	80~120	180~220	35~55
MW / LW	175~220	280~320	140~180
SW	170~320	280~420	110~180

(Note) Time of Scan Time 1 is about 0.5s. wait time when changing from upper limit frequency to lower limit frequency and about 1s when changing into SW meter band.

11. When semi-auto storing

IF signal count start

Wide : Count gate time at wide accuracy = 4ms (AM) / 1ms (FM)

Narrow : Count gate time at narrow accuracy = 16ms (AM) / 4ms (FM)

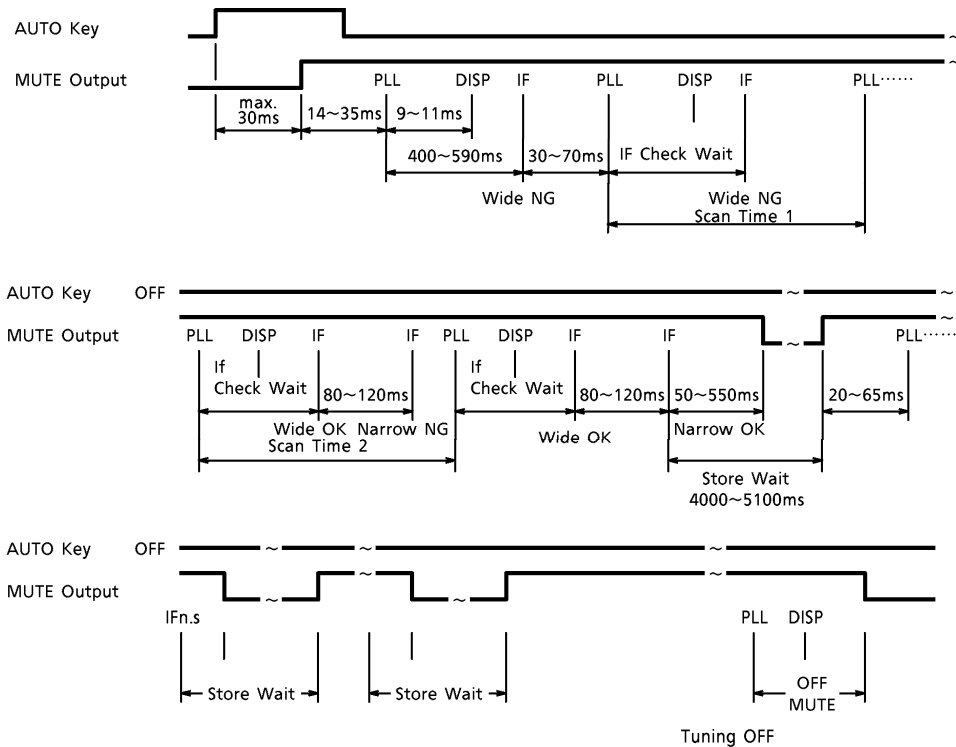

OFF MUTE

When write was made during the scan and store wait ;

570~670ms

When turned round by 2 turns without write

900~940ms

IF COUNTER

1. Principal function

When IF signal is sampled and conditions are met, steps the auto tuning.

2. Key to be used

None

3. Functions

- a. When the sampling is performed in the IF counter wide mode and IF signal is detected during the auto up tuning or semi-auto memory tuning, the same frequency is again checked in the IF counter narrow mode 100ms later and if IF signal is detected, the tuning is stopped.

- Example of IF Counter

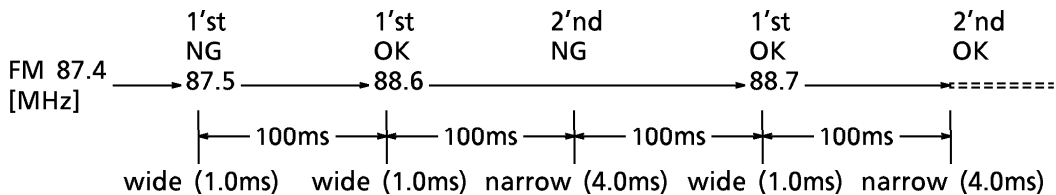

- b. IF counter detection width

BAND	1st TIME (WIDE)		2nd TIME (NARROW)	
	DETECTION WIDTH [Hz]	GATE TIME [ms]	DETECTION WIDTH [Hz]	GATE TIME [ms]
LW	450k ± 2.4k	4	450k ± 600	16
MW	450k ± 12k		450k ± 3k	
SW	450k ± 12k		450k ± 3k	
FM TV (1~3ch)	10.75M ± 60k ※	1	10.75M ± 15k ※	4
	10.70M ± 60k		10.70M ± 15k	
TV (4~62ch)	10.75M ± 120k ※		10.75M ± 30k ※	

(Note) ※ mark denotes the detection width for the specification for shipment in Japan.

INHIBIT FUNCTION

1. Principal function

Controls the radio ON / OFF.

2. Input to be used

$\overline{\text{INH}}$

3. Function

When $\overline{\text{INH}}$ input is at "L" level, a radio is OFF and the clock display results.

INITIALIZE

1. Principal function

The initialization is carried out when the power source (0V to more than 3V) to the controller is turned ON. (Power ON Reset)

2. Key to be used

None

3. Functions

a. When a radio is ON :

Lower frequency in a designated band is displayed.

b. When a radio is OFF :

AM 12 : 00 or 00 : 00 is displayed.

TEST

1. Principal function

LCD connection, timer and sleep functions can be checked.

2. Key to be used

TEST

3. Functions

a. While keep pushing both TEST key and except FAST key, all indications on LCD are kept ON.

b. Changed acceleration clock mode by pushed both TEST key and except FAST key (for 24 hours at 30s.), the functions of the timer and sleep can be checked.

Except TEST / FAST key pushed, acceleration clock mode is released.