

TOSHIBA BIPOLAR LINEAR INTEGRATED CIRCUIT SILICON MONOLITHIC

TA8142AP

REC / PLAY PRE AMP SYSTEM FOR DOUBLE CASSETTE

The TA8142AP is a Quad Pre Amplifier Designed for Use in Record / Play back Pre amplifier of Tape Recorder. It is Suitable for a Double Radio Cassette Recorder.

FEATURES

- Built in play back Amplifier
- Built in Recording Amplifier
- ALC Detector Circuit
- Operating Supply Voltage Range : $V_{CC(opr)} = 4 \sim 13.5V$ ($T_a = 25^\circ C$)

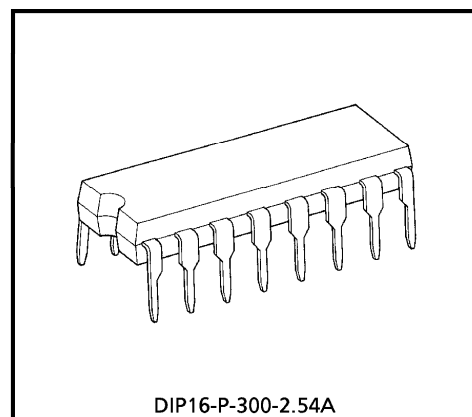

DIP16-P-300-2.54A
Weight : 1.00g (Typ.)

BLOCK DIAGRAM

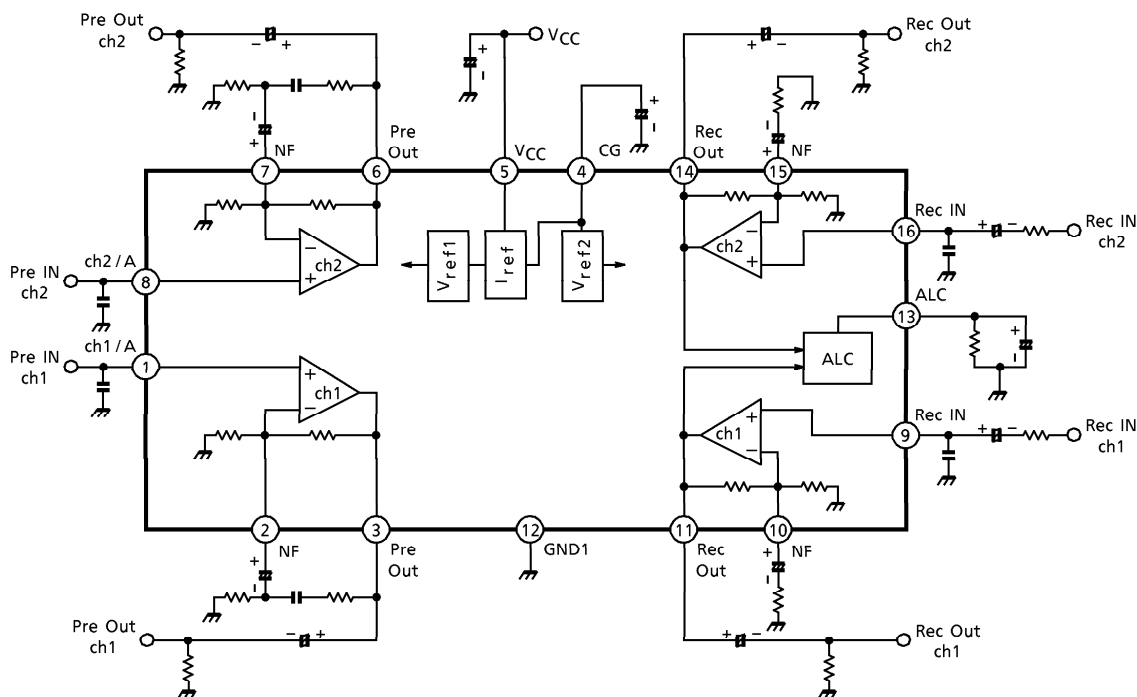

961001EBA2

● TOSHIBA is continually working to improve the quality and the reliability of its products. Nevertheless, semiconductor devices in general can malfunction or fail due to their inherent electrical sensitivity and vulnerability to physical stress. It is the responsibility of the buyer, when utilizing TOSHIBA products, to observe standards of safety, and to avoid situations in which a malfunction or failure of a TOSHIBA product could cause loss of human life, bodily injury or damage to property. In developing your designs, please ensure that TOSHIBA products are used within specified operating ranges as set forth in the most recent products specifications. Also, please keep in mind the precautions and conditions set forth in the TOSHIBA Semiconductor Reliability Handbook.

MAXIMUM RATINGS (Ta = 25°C)

CHARACTERISTIC	SYMBOL	RATING	UNIT
Supply Voltage	V _{CC}	14.5	V
Power Dissipation	P _D (Note)	750	mW
Operating Temperature	T _{opr}	-20~75	°C
Storage Temperature	T _{stg}	-55~150	°C

(Note) Derated above Ta = 25°C in the proportion of 6mW/°C.

ELECTRICAL CHARACTERISTICS (Unless otherwise specified, V_{CC} = 6V, f = 1kHz, B.P.F = 400Hz~30kHz)

CHARACTERISTIC	SYMBOL	TEST CIRCUIT	TEST CONDITION	MIN.	TYP.	MAX.	UNIT
Quiescent Current	I _{ccq}	—	—	—	9.5	15	mA
Play Back Amp.	Output Noise Voltage	V _{no} (Pre)	Normal Mode, R _g = 2.2kΩ, NAB EQ BW = 20Hz~20kHz, G _v = 40dB	—	150	350	μV _{rms}
	Total Harmonic Distortion	THD (Pre)	V _{out} = 0.2V _{rms} , f = 1kHz Normal Mode	—	0.05	0.1	%
	Maximum Output Voltage	V _{om} (Pre)	THD = 1.0%, R _L = 10kΩ, f = 1kHz Normal Mode	0.9	1.4	—	V _{rms}
	Open Loop Voltage Gain	G _{vo} (Pre)	f = 1kHz, R _L = 10kΩ V _{in} = 13.8μV _{rms} (-95dBm)	80	93	—	dB
	Cross Talk	C.T. (ch) (Pre)	V _{out} = 0.775V _{rms} (0dBm), f = 1kHz R _g = 2.2kΩ, Normal Mode	-70	-77	—	dB
	Ripple Rejection Ratio	R.R. (Pre)	V _{ripple} = 0.775V _{rms} (0dBm) fripple = 100Hz, Normal Mode R _g = 2.2kΩ, LPF = ~30kHz	—	-40	—	dB
	Voltage Gain	G _{vn} (Pre)	V _{in} = 7.75mV _{rms} (-40dBm) f = 1kHz, Normal NAB, R _L = 10kΩ	—	40	—	dB
Pre Amp → Rec Amp C.T.	C.T. (P/R)	—	f = 1kHz, V _{out} (Pre) = 0.775V _{rms} (0dBm), Normal (Pre)	—	-53.5	—	dB
Rec Amp → Pre Amp C.T.	C.T. (R/P)	—	f = 1kHz, V _{out} (Rec) = 0.775V _{rms} (0dBm), Normal (Pre)	—	-77.5	—	dB
Recording Amp.	Output Noise Level	V _{no} (Rec)	R _g = 2.2kΩ, BW = 20Hz~20kHz ALC OFF, G _v = 60dB	—	1.3	2.7	mV _{rms}
	Total Harmonic Distortion	THD (Rec)	V _{out} = 0.5V _{rms} , f = 1kHz ALC OFF, R _L = 10kΩ	—	0.35	0.9	%
	Maximum Output Level	V _{om} (Rec)	THD = 1%, R _L = 10kΩ, f = 1kHz ALC OFF	1.2	1.5	—	V _{rms}
	Open Loop Voltage Gain	G _{vo} (Rec)	f = 1kHz, R _L = 10kΩ, V _{in} = 3.16μV _{rms} (-110dBV)	76	86	—	dB
	ALC Range	R (ALC)	—	3dB up	—	50	—

961001EBA2'

- The products described in this document are subject to foreign exchange and foreign trade control laws.
- The information contained herein is presented only as a guide for the applications of our products. No responsibility is assumed by TOSHIBA CORPORATION for any infringements of intellectual property or other rights of the third parties which may result from its use. No license is granted by implication or otherwise under any intellectual property or other rights of TOSHIBA CORPORATION or others.
- The information contained herein is subject to change without notice.

CHARACTERISTIC	SYMBOL	TEST CIRCUIT	TEST CONDITION	MIN.	TYP.	MAX.	UNIT
Recording Amp.	Total Harmonic Distortion (ALC)	THD (ALC)	$V_{in} = 0.0775V_{rms}$ (-20dBm), $f = 1\text{kHz}$, dual input, $R_L = 10\text{k}\Omega$	—	0.3	0.9	%
	ALC Balance	B (ALC)	$V_{in} = 0.0775V_{rms}$ (-20dBm), dual input, $f = 1\text{kHz}$, $R_L = 10\text{k}\Omega$	-2	0	+2	dB
	ALC Level	V (ALC)	$V_{in} = 0.0775V_{rms}$ (-20dBm), $f = 1\text{kHz}$, $R_L = 10\text{k}\Omega$	0.75	1.0	1.2	V_{rms}
	Ripple Rejection Ratio	R.R. (Rec)	$V_R = 0.775V_{rms}$ (0dBm), $f = 100\text{Hz}$, $R_g = 2.2\text{k}\Omega$, LPF = ~30kHz	—	38	—	dB
	Voltage Gain	G_{vn} (Rec)	$f = 1\text{kHz}$ (FLAT), $R_L = 10\text{k}\Omega$, $V_{in} = 1\text{mV}_{rms}$ (-60dBV)	—	61	—	dB
	Cross Talk (ALC OFF)	C.T. (ch)	$V_{out} = 0.775V_{rms}$ (0dBm), $f = 1\text{kHz}$, $R_g = 2.2\text{k}\Omega$, ALC OFF	40	54	—	dB
	Cross Talk (ALC ON)	C.T. (ch)	$f = 1\text{kHz}$, $R_g = 2.2\text{k}\Omega$, ALC ON, $V_{in} = 0.0775V_{rms}$ (-20dBm)	40	52	—	dB

TEST CIRCUIT

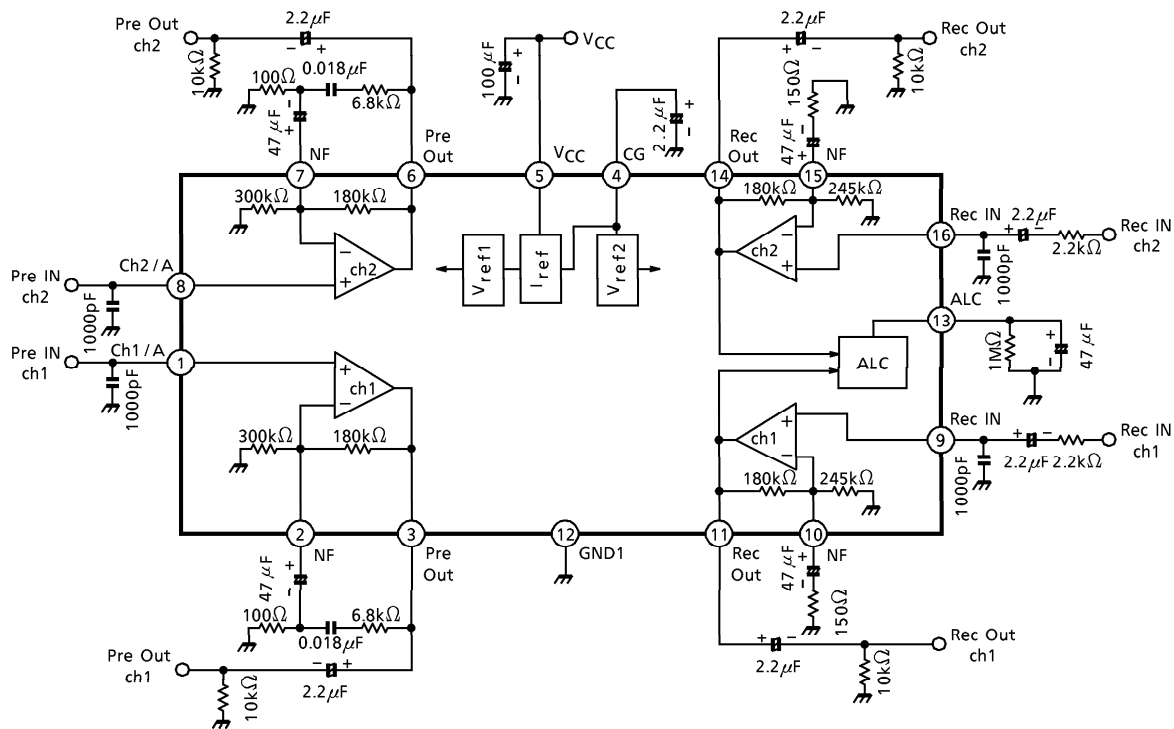

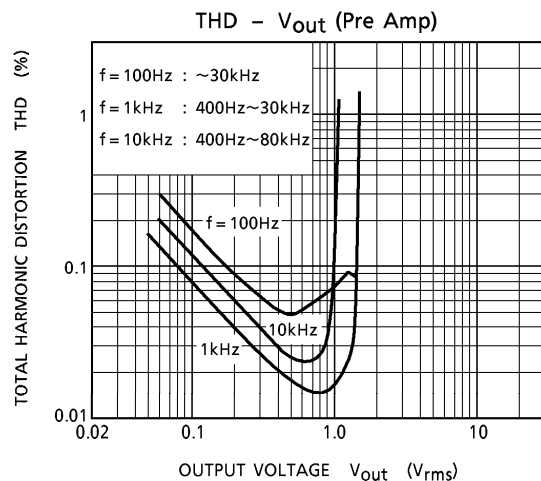
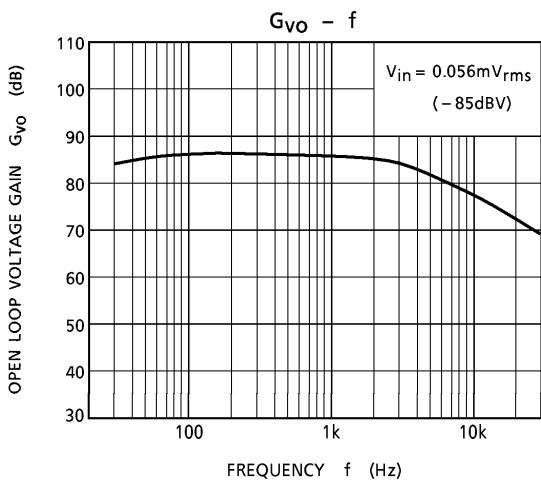
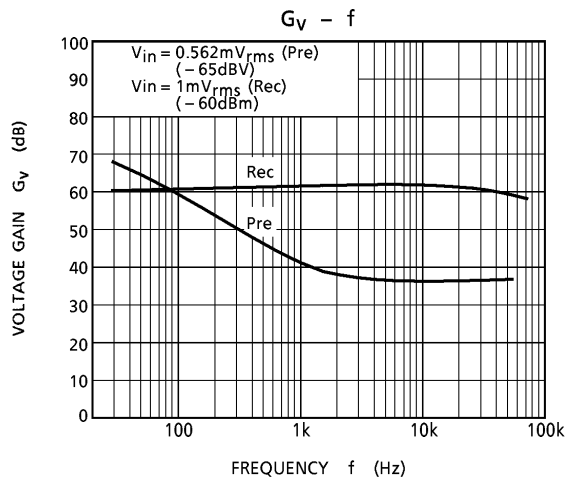
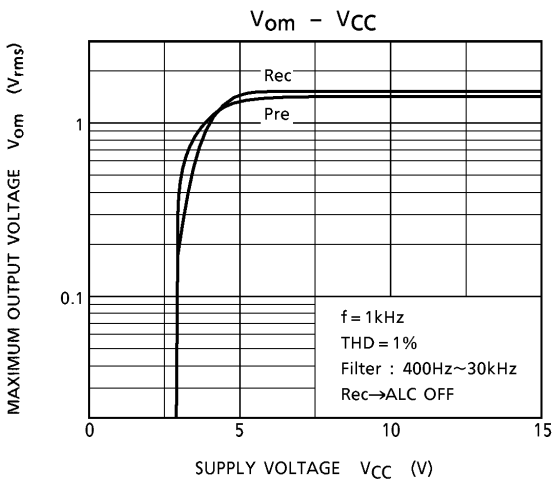
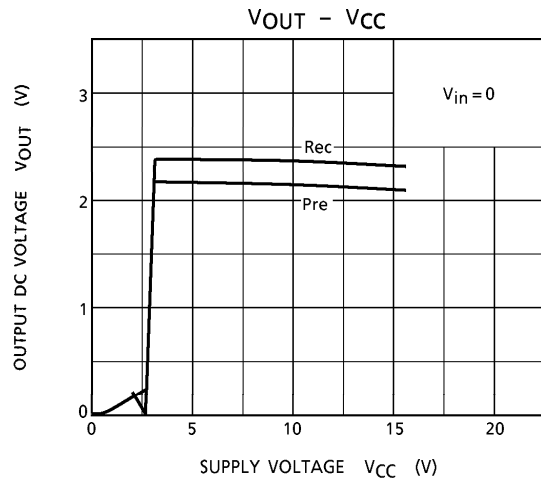
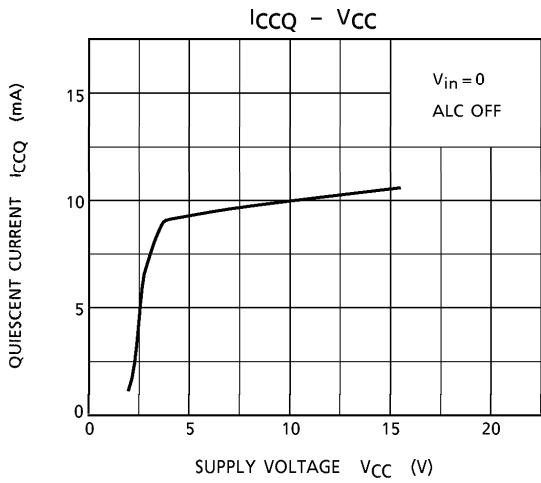

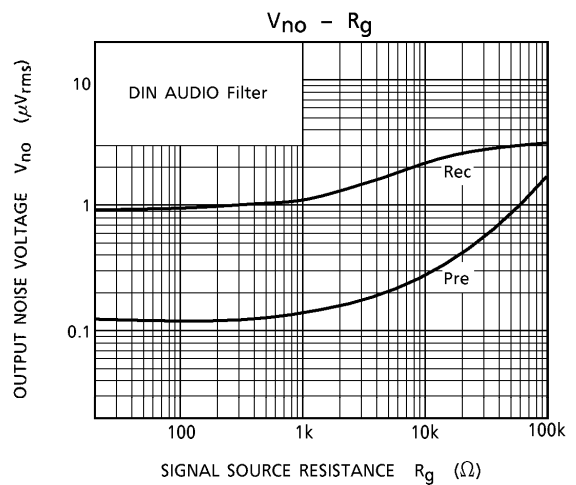
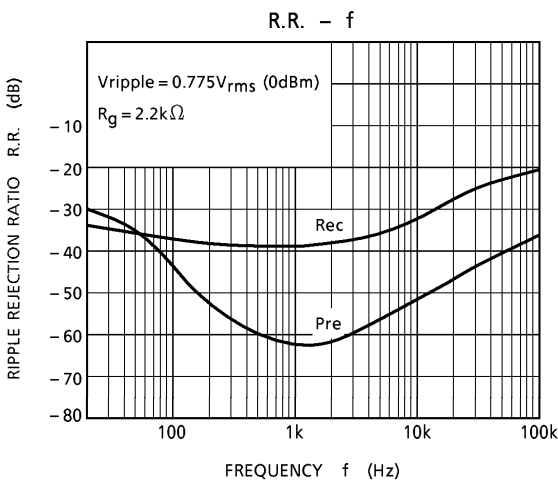
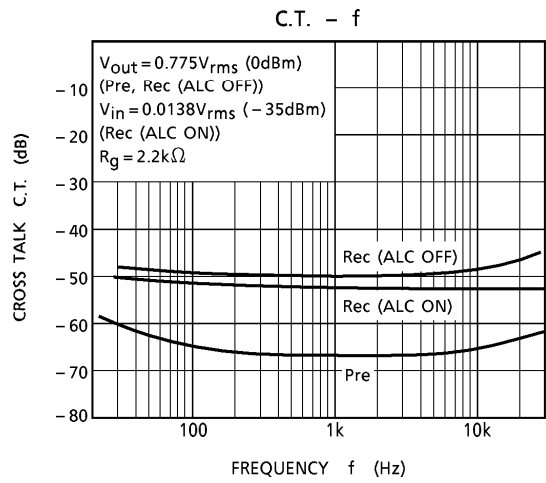
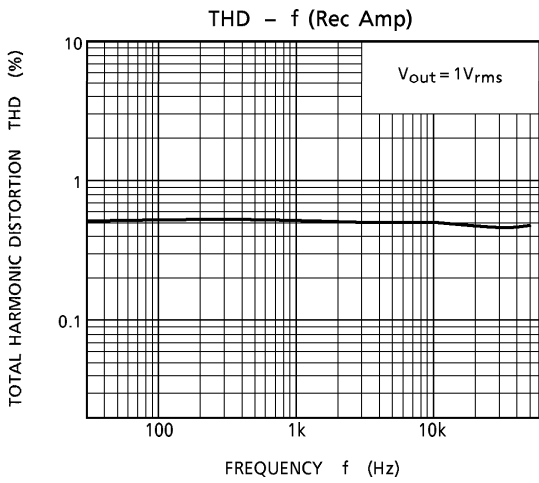
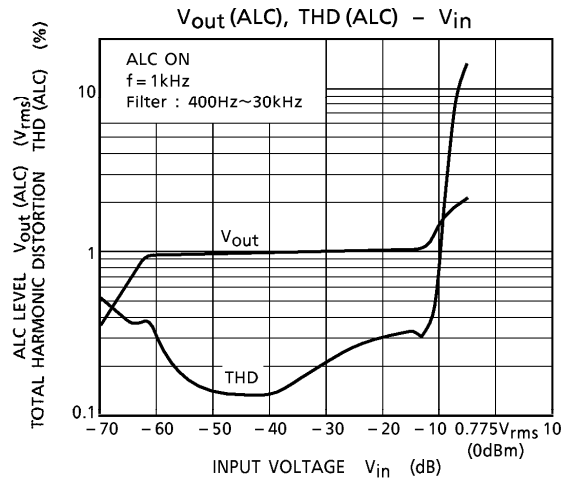
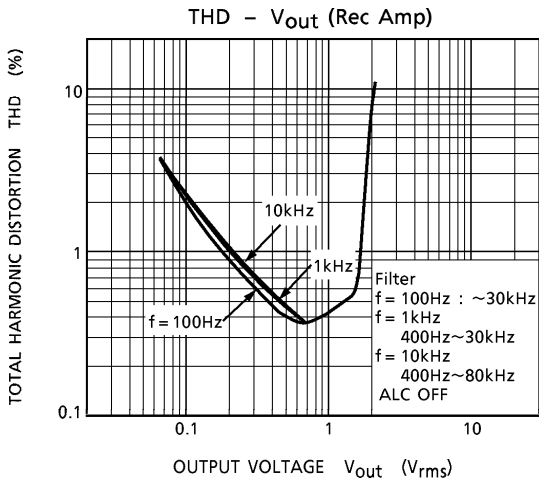

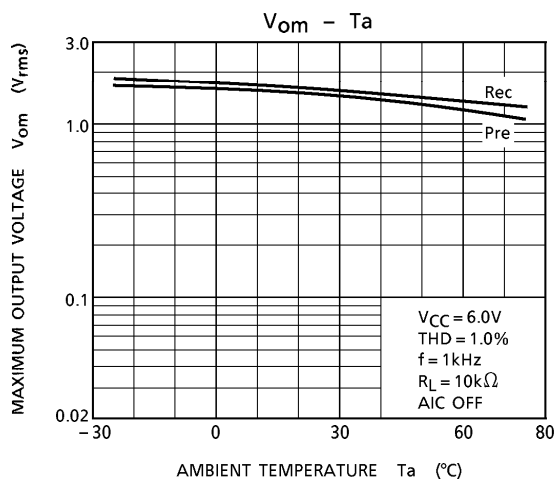
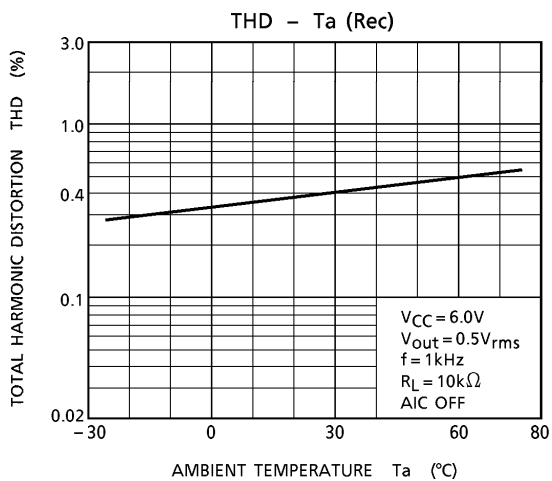
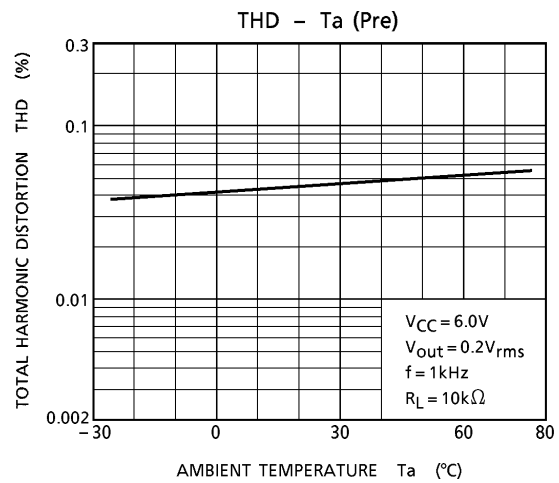
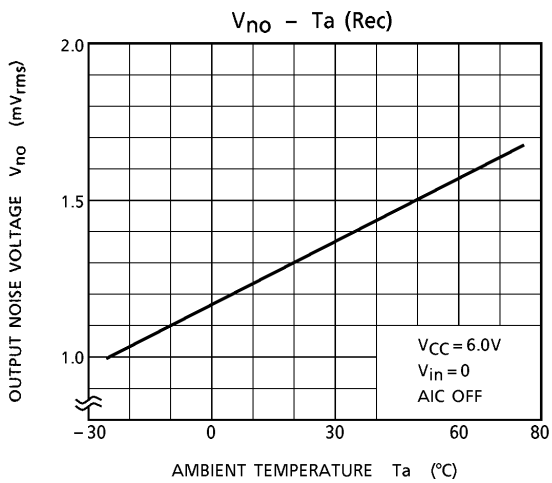
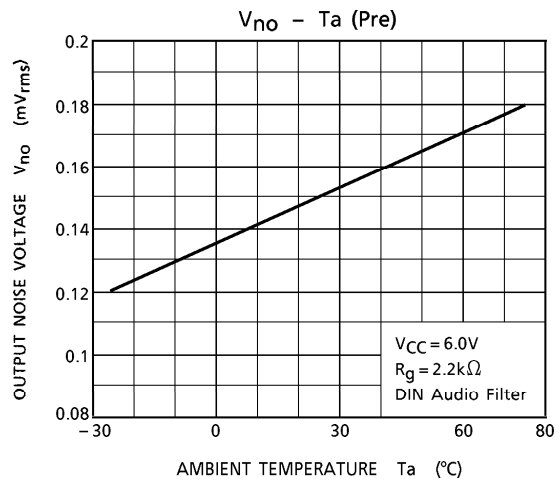
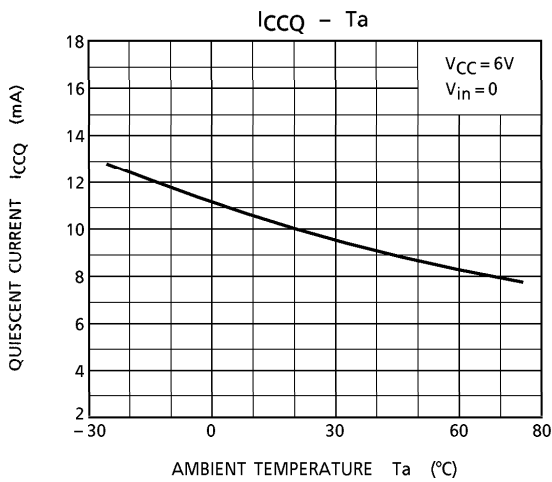

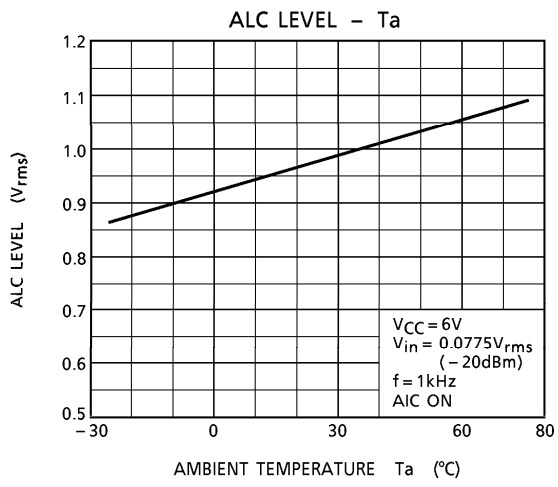

OUTLINE DRAWING
DIP16-P-300-2.54A

Unit : mm

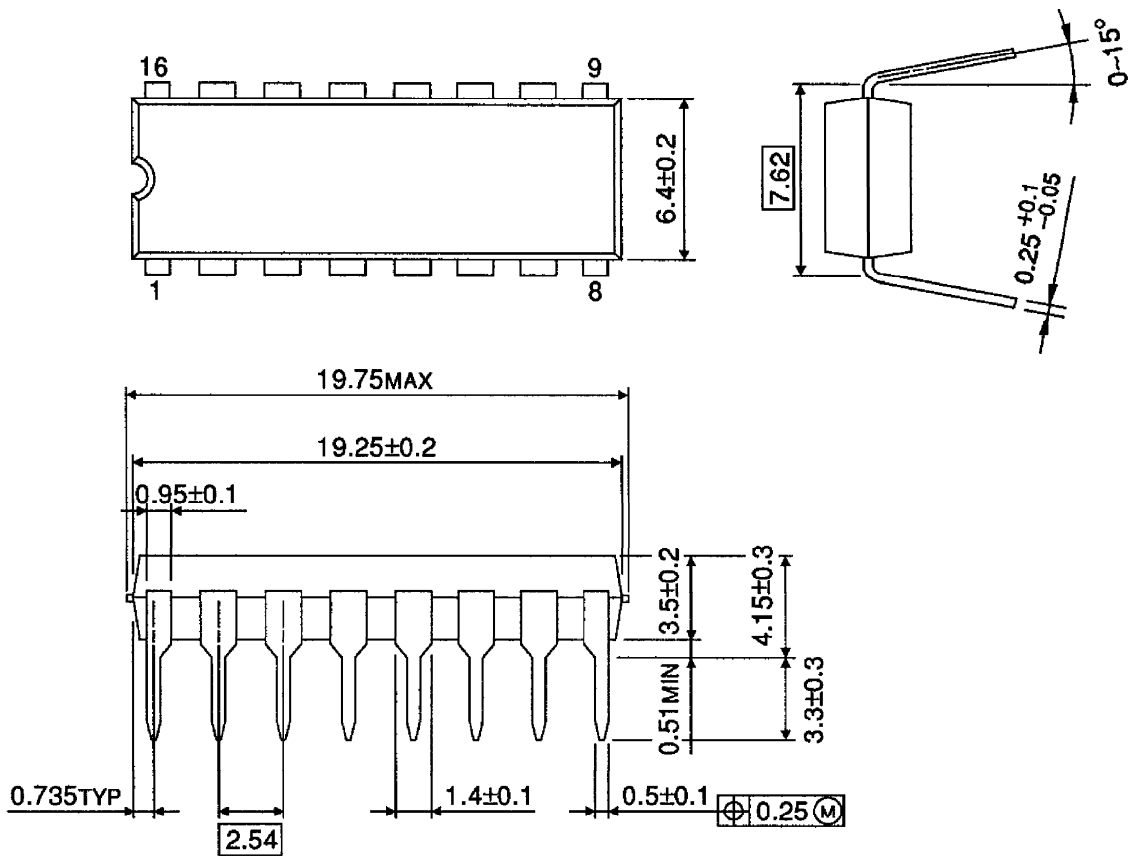

Weight : 1.00g (Typ.)