

TOSHIBA BIPOLAR LINEAR INTEGRATED CIRCUIT SILICON MONOLITHIC

# TA76431S

## ADJUSTABLE PRECISION SHUNT REGULATOR

### FEATURES

- Precision Reference Voltage :  $V_{REF} = 2.495V \pm 2\%$
- Small Temperature Coefficient :  $|\alpha V_{REF}| = 46\text{ppm}/^\circ\text{C}$
- Adjustable Output Voltage :  $V_{REF} \leq V_{OUT} \leq 36V$
- Low Dynamic Output Impedance :  $|Z_{KA}| = 0.15\Omega$  (Typ.)

### FUNCTIONAL BLOCK DIAGRAM

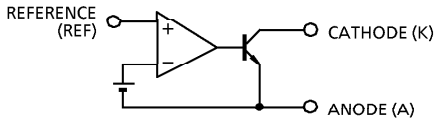

### CIRCUIT SYMBOL

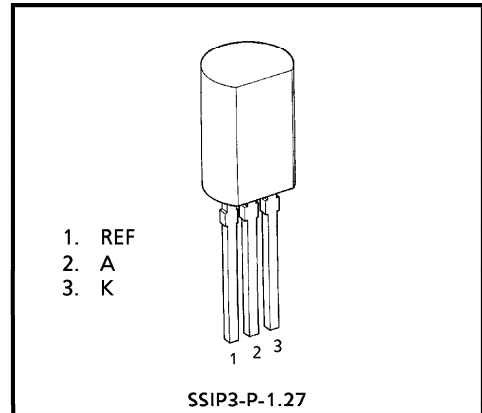
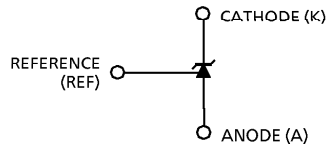

Weight : 0.36g (Typ.)

THIS IC CONTAINS ELECTROSTATIC SENSITIVE ELEMENT.  
PLEASE HANDLE WITH CAUTION.

### EQUIVALENT CIRCUIT

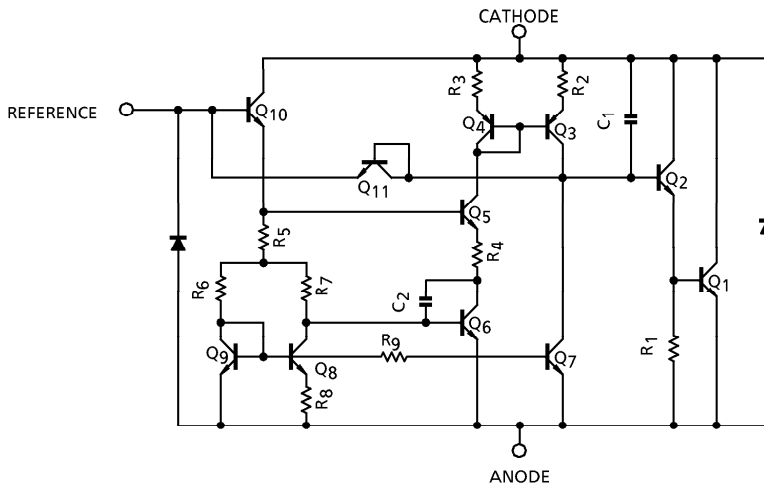

961001EBA2

- TOSHIBA is continually working to improve the quality and the reliability of its products. Nevertheless, semiconductor devices in general can malfunction or fail due to their inherent electrical sensitivity and vulnerability to physical stress. It is the responsibility of the buyer, when utilizing TOSHIBA products, to observe standards of safety, and to avoid situations in which a malfunction or failure of a TOSHIBA product could cause loss of human life, bodily injury or damage to property. In developing your designs, please ensure that TOSHIBA products are used within specified operating ranges as set forth in the most recent products specifications. Also, please keep in mind the precautions and conditions set forth in the TOSHIBA Semiconductor Reliability Handbook.
- The products described in this document are subject to foreign exchange and foreign trade control laws.
- The information contained herein is presented only as a guide for the applications of our products. No responsibility is assumed by TOSHIBA CORPORATION for any infringements of intellectual property or other rights of the third parties which may result from its use. No license is granted by implication or otherwise under any intellectual property or other rights of TOSHIBA CORPORATION or others.
- The information contained herein is subject to change without notice.

**MAXIMUM RATINGS** (Ta = 25°C)

CHARACTERISTIC		SYMBOL	RATING	UNIT
Cathode Voltage		$V_{KA}$	37	V
Cathode Current		$I_K$	- 100~150	mA
Reference Voltage		$V_{REF}$	7	V
Reference Current		$I_{REF}$	50	$\mu A$
Reference-Anode Reverse Current		$-I_{REF}$	10	mA
Power Dissipation	Ta = 25°C	$P_D$	800	mW
Operating Temperature		$T_{opr}$	- 40~85	°C
Storage Temperature		$T_{stg}$	- 55~150	°C

**RECOMMENDED OPERATING CONDITIONS**

CHARACTERISTIC	SYMBOL	MIN.	TYP.	MAX.	UNIT
Cathode Voltage	$V_{KA}$	$V_{REF}$	—	36	V
Cathode Current	$I_K$	1	—	100	mA
Operating Temperature	$T_{opr}$	- 40	—	85	°C

**ELECTRICAL CHARACTERISTICS** (Unless otherwise specified, Ta = 25°C, I<sub>K</sub> = 10mA)

CHARACTERISTIC	SYMBOL	TEST CIRCUIT	TEST CONDITION	MIN.	TYP.	MAX.	UNIT
Reference Voltage	V <sub>REF</sub>	—	V <sub>KA</sub> = V <sub>REF</sub>	2.440	2.495	2.550	V
Deviation of Reference Input Voltage Over Temperature	V <sub>REF</sub> (dev) (Note)	—	0°C ≤ Ta ≤ 70°C V <sub>KA</sub> = V <sub>REF</sub>	—	8	17	mV
Ratio of Change in Reference Input Voltage to the Change in Cathode Voltage	ΔV <sub>REF</sub> / ΔV	—	V <sub>REF</sub> ≤ V <sub>KA</sub> ≤ 10V	—	0.8	2.7	mV/V
		—	10V ≤ V <sub>KA</sub> ≤ 36V	—	0.5	2.0	
Reference Input Current	I <sub>REF</sub>	—	V <sub>KA</sub> = V <sub>REF</sub>	—	1.4	4	μA
Deviation of Reference Input Current Over Temperature	I <sub>REF</sub> (dev) (Note)	—	0°C ≤ Ta ≤ 70°C, V <sub>KA</sub> = V <sub>REF</sub> R <sub>1</sub> = 10kΩ, R <sub>2</sub> = ∞	—	0.3	1.2	μA
Minimum Cathode Current for Regulation	I <sub>Kmin</sub>	—	V <sub>KA</sub> = V <sub>REF</sub>	—	0.4	1.0	mA
Off-State Cathode Current	I <sub>Koff</sub>	—	V <sub>KA</sub> = 36V, V <sub>REF</sub> = 0V	—	—	1.0	μA
Dynamic Impedance	Z <sub>KA</sub>	—	V <sub>KA</sub> = V <sub>REF</sub> , f ≤ 1kHz 1mA ≤ I <sub>K</sub> ≤ 100mA	—	0.15	0.5	Ω

Note : The deviation parameters V<sub>REF</sub> (dev) and I<sub>REF</sub> (dev) are defined as the maximum variation of the V<sub>REF</sub> and I<sub>REF</sub> over the rated temperature range.  
The average temperature coefficient of the V<sub>REF</sub> is defined as ;

$$|\alpha V_{REF}| = \frac{\frac{V_{REF} (dev)}{V_{REF@25^\circ C}} \times 10^6}{\Delta Ta} \text{ (ppm / } ^\circ\text{C)}$$

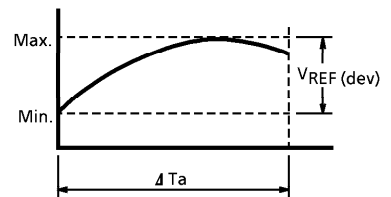

TEST PARAMETER

(1)  $V_{KA} = V_{REF}$  MODE

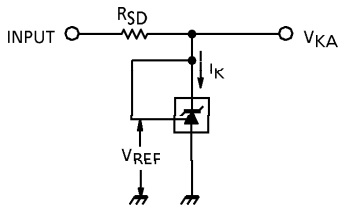

(2)  $V_{KA} > V_{REF}$  MODE

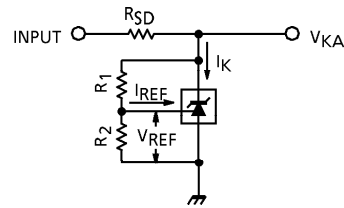

$$V_{KA} = V_{REF} \left( 1 + \frac{R_1}{R_2} \right) + I_{REF} \cdot R_1$$

(3) OFF-STATE MODE

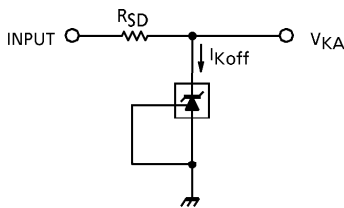

TYPICAL APPLICATIONS

(1) 2.5V REFERENCE

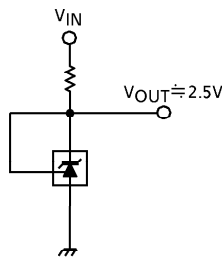

(2) SHUNT REGULATOR

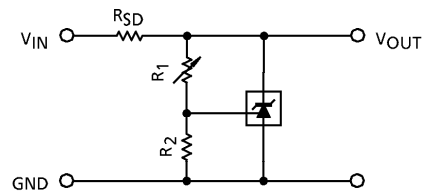

$$V_{OUT} = V_{REF} \left( 1 + \frac{R_1}{R_2} \right) + I_{REF} \cdot R_1$$

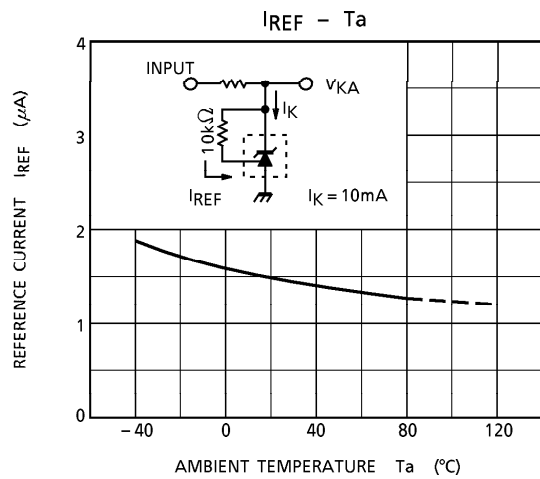
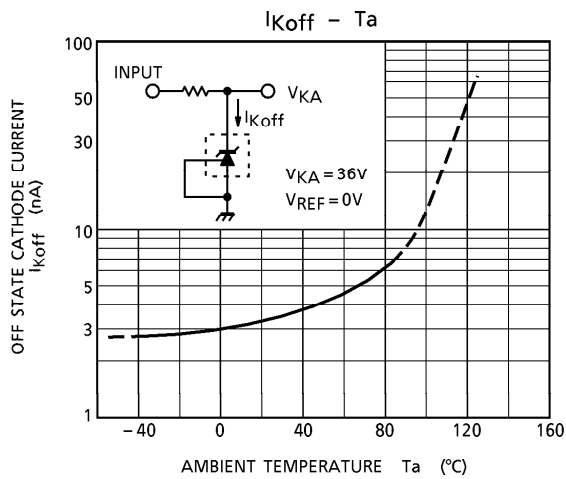
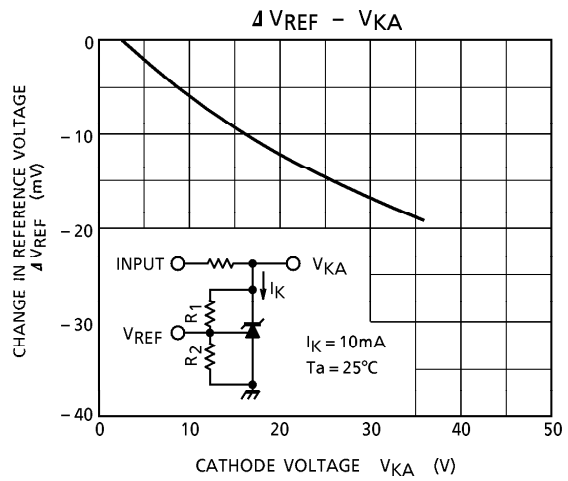
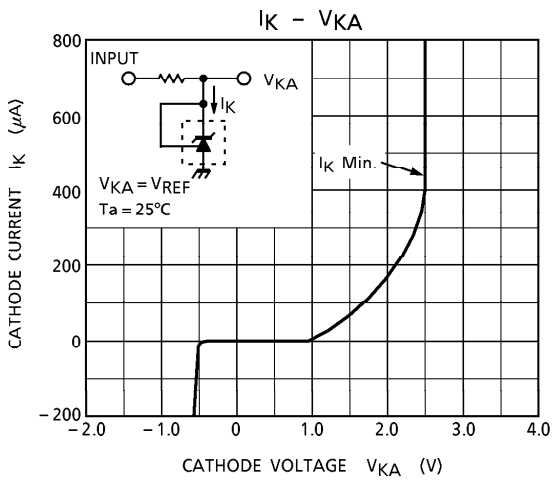
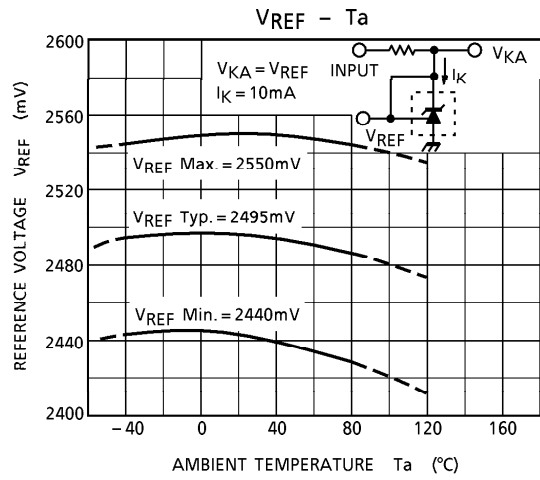
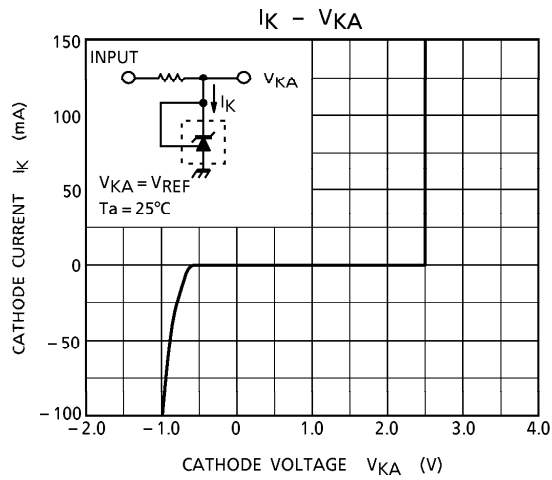

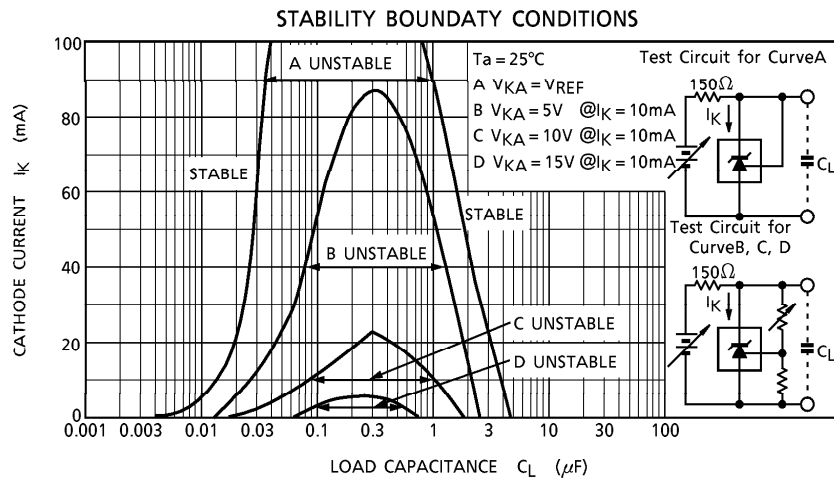
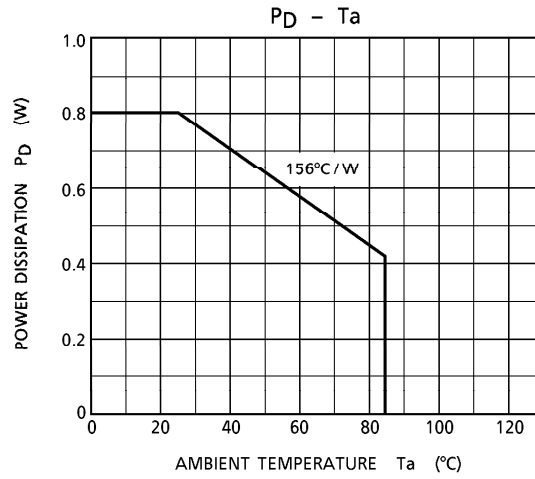
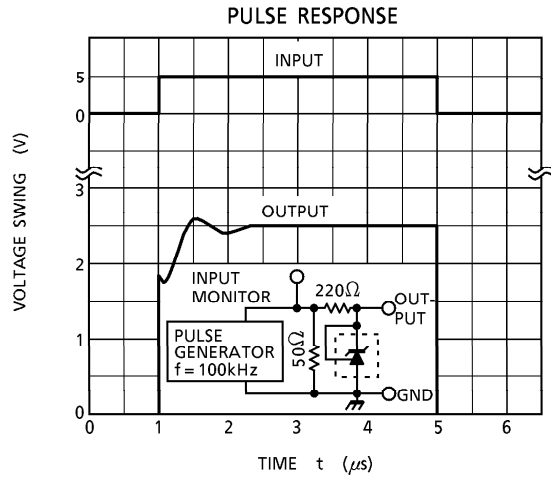
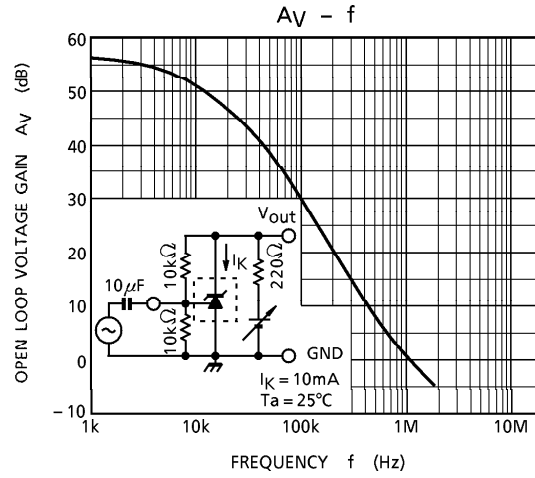
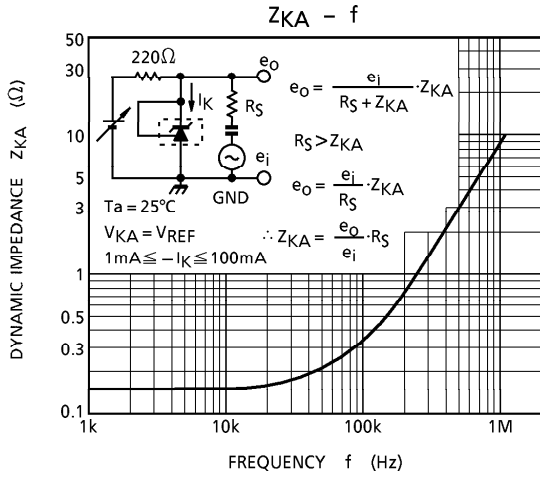

OUTLINE DRAWING  
SSIP3-P-1.27

Unit : mm

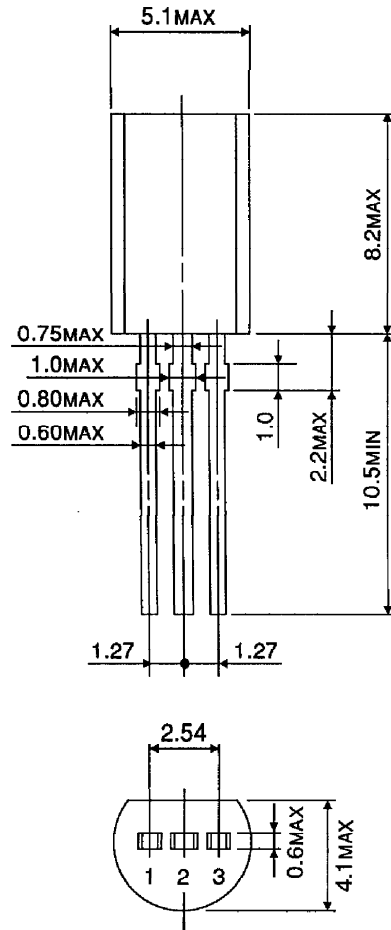

Weight : 0.36g (Typ.)