

TPS2330, TPS2331 SINGLE HOT SWAP POWER CONTROLLER WITH CIRCUIT BREAKER AND POWER-GOOD REPORTING

SLVS277A – MARCH 2000 – REVISED APRIL 2000

features

- Single-Channel High-Side MOSFET Driver
- Input Voltage: 3 V to 13 V
- Inrush Current Limiting With dv/dt Control
- Circuit-Breaker Control With Programmable Current Limit and Transient Timer
- Power-Good Reporting With Transient Filter
- CMOS- and TTL-Compatible Enable Input
- Low 5- μ A Standby Supply Current . . . Max
- Available in 14-Pin SOIC and TSSOP Package
- -40°C to 85°C Ambient Temperature Range
- Electrostatic Discharge Protection

applications

- Hot-Swap/Plug/Dock Power Management
- Hot-Plug PCI, Device Bay
- Electronic Circuit Breaker

description

The TPS2330 and TPS2331 are single-channel hot-swap controllers that use external N-channel MOSFETs as high-side switches in power applications. Features of these devices, such as overcurrent protection (OCP), inrush-current control, output-power status reporting, and separation of load transients from actual load increases, are critical requirements for hot-swap applications.

The TPS2330/31 devices incorporate undervoltage lockout (UVLO) and power-good (PG) reporting to ensure the device is off at start-up and confirm the status of the output voltage rails during operation. An internal charge pump, capable of driving multiple MOSFETs, provides enough gate-drive voltage to fully enhance the N-channel MOSFETs. The charge pump controls both the rise times and fall times (dv/dt) of the MOSFETs, reducing power transients during power up/down. The circuit-breaker functionality combines the ability to sense overcurrent conditions with a timer function; this allows designs such as DSPs, that may have high peak currents during power-state transitions, to disregard transients for a programmable period.

D OR PW PACKAGE (TOP VIEW)

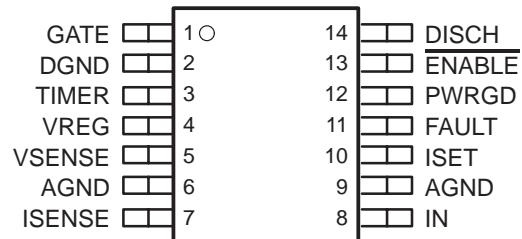

NOTE: Terminal 13 is active high on TPS2331.

typical application

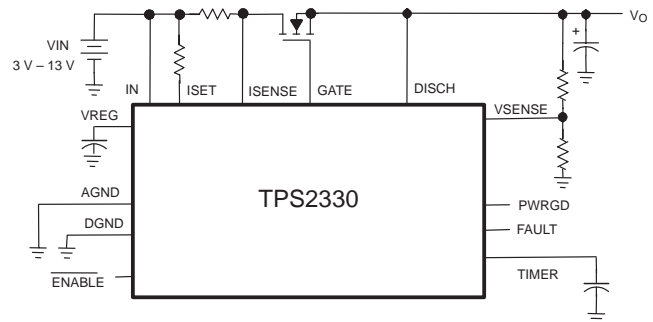

AVAILABLE OPTIONS

TA	HOT-SWAP CONTROLLER DESCRIPTION	PIN COUNT	PACKAGES	
			ENABLE	ENABLE
-40°C to 85°C	Dual-channel with independent OCP and adjustable PG	20	TPS2300IPW	TPS2301IPW
	Dual-channel with interdependent OCP and adjustable PG	20	TPS2310IPW	TPS2311IPW
	Dual-channel with independent OCP	16	TPS2320ID TPS2320IPW	TPS2321ID TPS2321IPW
	Single-channel with OCP and adjustable PG	14	TPS2330ID TPS2330IPW	TPS2331ID TPS2331IPW

† The packages are available left-end taped and reeled (indicated by the R suffix on the device type; e.g., TPS2331IPWR).



Please be aware that an important notice concerning availability, standard warranty, and use in critical applications of Texas Instruments semiconductor products and disclaimers thereto appears at the end of this data sheet.

PRODUCTION DATA information is current as of publication date. Products conform to specifications per the terms of Texas Instruments standard warranty. Production processing does not necessarily include testing of all parameters.

**TEXAS
INSTRUMENTS**

POST OFFICE BOX 655303 • DALLAS, TEXAS 75265

Copyright © 2000, Texas Instruments Incorporated

TPS2330, TPS2331 SINGLE HOT SWAP POWER CONTROLLER WITH CIRCUIT BREAKER AND POWER-GOOD REPORTING

SLVS277A – MARCH 2000 – REVISED APRIL 2000

functional block diagram

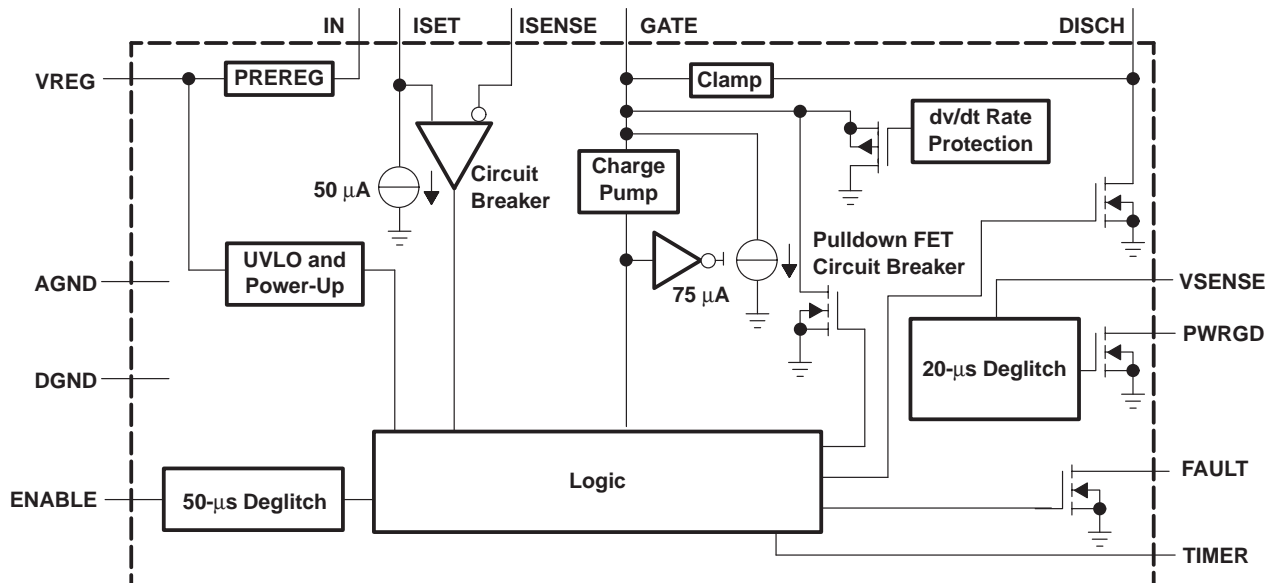

Terminal Functions

TERMINAL NAME	NO.	I/O	DESCRIPTION
AGND	6,9	I	Analog ground, connects to DGND as close as possible
DGND	2	I	Digital ground
DISCH	14	O	Discharge transistor
ENABLE/ ENABLE	13	I	Active low (TPS2330) or active high enable (TPS2331)
FAULT	11	O	Overcurrent fault, open-drain output
GATE	1	O	Connects to gate of high-side MOSFET
IN	8	I	Input voltage
ISENSE	7	I	Current-sense input
ISET	10	I	Adjusts circuit-breaker threshold with resistor connected to IN
PWRGD	12	O	Open-drain output, asserted low when VSENSE voltage is less than reference.
TIMER	3	O	Adjusts circuit-breaker deglitch time
VREG	4	O	Connects to bypass capacitor, for stable operation
VSENSE	5	I	Power-good sense input

detailed description

DISCH – DISCH should be connected to the source of the external N-channel MOSFET transistor connected to GATE. This pin discharges the load when the MOSFET transistor is disabled. They also serve as reference-voltage connection for internal gate-voltage-clamp circuitry.

ENABLE or ENABLE – $\overline{\text{ENABLE}}$ for TPS2330 is active low. ENABLE for TPS2331 is active high. When the controller is enabled, GATE voltage will power up to turn on the external MOSFETs. When the $\overline{\text{ENABLE}}$ pin is pulled high for TPS2330 or the ENABLE pin is pulled low for TPS2331 for more than 50 μs , the gate of the MOSFET is discharged at a controlled rate by a current source, and a transistor is enabled to discharge the output bulk capacitance. In addition, the device turns on the internal regulator PREREG (see VREG) when enabled and shuts down PREREG when disabled so that total supply current is much less than 5 μA .

FAULT – FAULT is an open-drain overcurrent flag output. When an overcurrent condition is sustained long enough to charge TIMER to 0.5 V, the device latches off and pulls FAULT low.

GATE – GATE connects to the gate of the external N-channel MOSFET transistor. When the device is enabled, internal charge-pump circuitry pulls this pin up by sourcing approximately 15 μA . The turnon slew rates depend upon the capacitance present at the GATE terminal. If desired, the turnon slew rates can be further reduced by connecting capacitors between this pin and ground. These capacitors also reduce inrush current and protect the device from false overcurrent triggering during powerup. The charge-pump circuitry will generate gate-to-source voltages of 9 V–12 V across the external MOSFET transistor.

IN – IN should be connected to the power source driving the external N-channel MOSFET transistor connected to GATE. The TPS2330/31 draws its operating current from IN, and will remain disabled until the IN power supply has been established. The device has been constructed to support 3-V, 5-V, or 12-V operation.

ISENSE, ISET – ISENSE in combination with ISET implements overcurrent sensing for GATE. ISET sets the magnitude of the current that generates an overcurrent fault, through a external resistor connected to ISET. An internal current source draws 50 μA from ISET. With a sense resistor from IN to ISENSE, which is also connected to the drain of the external MOSFET, the voltage on the sense resistor reflects the load current. An overcurrent condition is assumed to exist if ISENSE is pulled below ISET.

PWRGD – PWRGD signals the presence of undervoltage conditions on VSENSE. The pin is an open-drain output and is pulled low during an undervoltage condition. To minimize erroneous PWRGD responses from transients on the voltage rail, the voltage sense circuit incorporates a 20- μs deglitch filter. When VSENSE is lower than the reference voltage (about 1.23 V), PWRGD will be active low to indicate an undervoltage condition on the power-rail voltage.

TIMER – A capacitor on TIMER sets the time during which the power switch can be in overcurrent before turning off. When the overcurrent protection circuits sense an excessive current, a current source is enabled which charges the capacitor on TIMER. Once the voltage on TIMER reaches approximately 0.5 V, the circuit-breaker latch is set and the power switch is latched off. Power must be recycled or the ENABLE pin must be toggled to restart the controller. In high-power or high-temperature applications, a minimum 50-pF capacitor is strongly recommended from TIMER to ground, to prevent any false triggering.

VREG – The VREG pin is the output of an internal low-dropout voltage regulator. This regulator draws current from IN. A 0.1- μF ceramic capacitor should be connected between VREG and ground. VREG can be connected to IN or to a separated power supply through a low-resistance resistor. However, the voltage on VREG must be less than 5.5 V.

VSENSE – VSENSE can be used to detect undervoltage conditions on external circuitry. If VSENSE senses a voltage below approximately 1.23 V, PWRGD is pulled low.

TPS2330, TPS2331 SINGLE HOT SWAP POWER CONTROLLER WITH CIRCUIT BREAKER AND POWER-GOOD REPORTING

SLVS277A – MARCH 2000– REVISED APRIL 2000

absolute maximum ratings over operating free-air temperature (unless otherwise noted)†

Input voltage range: $V_{I(IN)}$, $V_{I(ISENSE)}$, $V_{I(VSENSE)}$, $V_{I(ISET)}$, $V_{I(ENABLE)}$ -0.3 V to 15 V
 Output voltage range: $V_{O(GATE)}$ -0.3 V to 30 V
 $V_{O(DISCH)}$, $V_{O(PWRGD)}$, $V_{O(FAULT)}$, $V_{O(VREG)}$, $V_{O(TIMER)}$ -0.3 V to 15V
 Sink current range: I_{GATE} , I_{DISCH} 0 mA to 100 mA
 I_{PWRGD} , I_{TIMER} , I_{FAULT} 0 mA to 10 mA
 Operating virtual junction temperature range, T_J -40°C to 100°C
 Storage temperature range, T_{stg} -55°C to 150°C
 Lead temperature 1,6 mm (1/16 inch) from case for 10 seconds 260°C

† Stresses beyond those listed under “absolute maximum ratings” may cause permanent damage to the device. These are stress ratings only, and functional operation of the device at these or any other conditions beyond those indicated under “recommended operating conditions” is not implied. Exposure to absolute-maximum-rated conditions for extended periods may affect device reliability.

NOTE 1: All voltages are respect to DGND.

DISSIPATION RATING TABLE

PACKAGE	$T_A \leq 25^\circ\text{C}$ POWER RATING	DERATING FACTOR ABOVE $T_A = 25^\circ\text{C}$	$T_A = 70^\circ\text{C}$ POWER RATING	$T_A = 85^\circ\text{C}$ POWER RATING
PW-14	755 mW	10.07 mW/°C	302 mW	151 mW
D-14	613 mW	8.18 mW/°C	245 mW	123 mW

recommended operating conditions

	MIN	NOM	MAX	UNIT
Input voltage, V_I		3	13	V
$V_{I(IN)}$, $V_{I(ISENSE)}$, $V_{I(VSENSE)}$, $V_{I(ISET)}$				
VREG voltage, $V_{O(VREG)}$, when VREG is directly connected to IN		2.95	5.5	V
Operating virtual junction temperature, T_J	-40		100	°C



TPS2330, TPS2331
SINGLE HOT SWAP POWER CONTROLLER WITH
CIRCUIT BREAKER AND POWER-GOOD REPORTING

SLVS277A – MARCH 2000– REVISED APRIL 2000

electrical characteristics over recommended operating temperature range ($-40^{\circ}\text{C} < T_A < 85^{\circ}\text{C}$),
 $3\text{ V} \leq V_{I(\text{IN})} \leq 13\text{ V}$ (unless otherwise noted)

general

PARAMETER		TEST CONDITIONS	MIN	TYP	MAX	UNIT
$I_{I(\text{IN})}$	Input current, IN	$V_{I(\text{ENABLE})} = 5\text{ V}$ (TPS2331),		0.5	1	mA
		$V_{I(\text{ENABLE})} = 0\text{ V}$ (TPS2330)		75	200	
$I_{I(\text{stby})}$	Standby current (sum of currents into IN ISENSE and ISET)	$V_{I(\text{ENABLE})} = 0\text{ V}$ (TPS2331), $V_{I(\text{ENABLE})} = 5\text{ V}$ (TPS2330)			5	μA

GATE

PARAMETER		TEST CONDITIONS	MIN	TYP	MAX	UNIT
$V_{G(\text{GATE_}3\text{V})}$	Gate voltage	$I_{I(\text{GATE})} = 500\text{ nA}$, DISCH open	$V_{I(\text{IN})} = 3\text{ V}$	9	11.5	V
$V_{G(\text{GATE_}4.5\text{V})}$			$V_{I(\text{IN})} = 4.5\text{ V}$	10.5	14.5	
$V_{G(\text{GATE_}10.8\text{V})}$			$V_{I(\text{IN})} = 10.8\text{ V}$	16.8	21	
$V_{C(\text{GATE})}$	Clamping voltage, GATE to DISCH		9	10	12	V
$I_{S(\text{GATE})}$	Source current, GATE	$3\text{ V} \leq V_{I(\text{IN})} \leq 13.2\text{ V}$, $3\text{ V} \leq V_{O(\text{VREG})} \leq 5.5\text{ V}$, $V_{I(\text{GATE})} = V_{I(\text{IN})} + 6\text{ V}$	10	14	20	μA
	Sink current, GATE	$3\text{ V} \leq V_{I(\text{IN})} \leq 13.2\text{ V}$, $3\text{ V} \leq V_{O(\text{VREG})} \leq 5.5\text{ V}$, $V_{I(\text{GATE})} = V_{I(\text{IN})}$	50	75	100	μA
$t_{r(\text{GATE})}$	Rise time, GATE	C_g to GND = 1 nF (see Note 2)	$V_{I(\text{IN})} = 3\text{ V}$	0.5		ms
			$V_{I(\text{IN})} = 4.5\text{ V}$	0.6		
			$V_{I(\text{IN})} = 10.8\text{ V}$	1		
$t_{f(\text{GATE})}$	Fall time, GATE	C_g to GND = 1 nF (see Note 2)	$V_{I(\text{IN})} = 3\text{ V}$	0.1		ms
			$V_{I(\text{IN})} = 4.5\text{ V}$	0.12		
			$V_{I(\text{IN})} = 10.8\text{ V}$	0.2		

NOTE 2: Specified, but not production tested.

TIMER

PARAMETER		TEST CONDITIONS	MIN	TYP	MAX	UNIT
$V_{OT(\text{TIMER})}$	Threshold voltage, TIMER		0.4	0.5	0.6	V
	Charge current, TIMER	$V_{I(\text{TIMER})} = 0\text{ V}$	35	50	65	μA
	Discharge current, TIMER	$V_{I(\text{TIMER})} = 1\text{ V}$	1	2.5		mA

circuit breaker

PARAMETER		TEST CONDITIONS	MIN	TYP	MAX	UNIT
$V_{IT(\text{CB})}$	Undervoltage voltage, circuit breaker	$R_{I\text{SET}} = 1\text{ k}\Omega$	40	50	60	mV
$I_{IB(\text{ISENSE})}$	Input bias current, ISENSE			0.1	5	μA
	Discharge current, GATE	$V_{O(\text{GATE})} = 4\text{ V}$	400	800		mA
		$V_{O(\text{GATE})} = 1\text{ V}$	25	150		
$t_{pd(\text{CB})}$	Propagation (delay) time, comparator inputs to gate output	$C_g = 50\text{ pF}$, 10 mV overdrive, (50% to 10%) $C_{O(\text{timer})} = 50\text{ pF}$		1.3		μs



TPS2330, TPS2331 SINGLE HOT SWAP POWER CONTROLLER WITH CIRCUIT BREAKER AND POWER-GOOD REPORTING

SLVS277A – MARCH 2000– REVISED APRIL 2000

electrical characteristics over recommended operating temperature range ($-40^{\circ}\text{C} < T_A < 85^{\circ}\text{C}$),
 $3\text{ V} \leq V_{I(IN)} \leq 13\text{ V}$ (unless otherwise noted) (continued)

ENABLE, active low (TPS2330)

PARAMETER	TEST CONDITIONS	MIN	TYP	MAX	UNIT	
$V_{IH}(\overline{\text{ENABLE}})$	High-level input voltage, $\overline{\text{ENABLE}}$	2			V	
$V_{IL}(\overline{\text{ENABLE}})$	Low-level input voltage, $\overline{\text{ENABLE}}$			0.8	V	
$R_{I}(\overline{\text{ENABLE}})$	Input pullup resistance, $\overline{\text{ENABLE}}$	See Note 3	100	200	300	k Ω
$t_{d_off}(\overline{\text{ENABLE}})$	Turnoff delay time, $\overline{\text{ENABLE}}$	$V_{I}(\overline{\text{ENABLE}})$ increasing above stop threshold; 100 ns rise time, 20 mV overdrive (see Note 2)			60	μs
$t_{d_on}(\overline{\text{ENABLE}})$	Turnon delay time, $\overline{\text{ENABLE}}$	$V_{I}(\overline{\text{ENABLE}})$ decreasing below start threshold; 100 ns fall time, 20 mV overdrive (see Note 2)			125	μs

NOTES: 2. Specified, but not production tested.

3. Test I_O of $\overline{\text{ENABLE}}$ at $V_{I}(\overline{\text{ENABLE}}) = 1\text{ V}$ and 0 V , then $R_{I}(\overline{\text{ENABLE}}) = \frac{1\text{ V}}{I_{O_0V} - I_{O_1V}}$

ENABLE, active high (TPS2331)

PARAMETER	TEST CONDITIONS	MIN	TYP	MAX	UNIT	
$V_{IH}(\text{ENABLE})$	High-level input voltage, ENABLE	2			V	
$V_{IL}(\text{ENABLE})$	Low-level input voltage, ENABLE			0.7	V	
$R_{I}(\text{ENABLE})$	Input pulldown resistance, ENABLE	100	150	300	k Ω	
$t_{d_on}(\text{ENABLE})$	Turnon delay time, ENABLE	$V_{I}(\text{ENABLE})$ increasing above start threshold; 100 ns rise time, 20 mV overdrive (see Note 2)			85	μs
$t_{d_off}(\text{ENABLE})$	Turnoff delay time, ENABLE	$V_{I}(\text{ENABLE})$ decreasing below stop threshold; 100 ns fall time, 20 mV overdrive (see Note 2)			100	μs

NOTE 2: Specified, but not production tested.

PREREG

PARAMETER	TEST CONDITIONS	MIN	TYP	MAX	UNIT			
VREG	PREREG output voltage	$4.5 \leq V_{I(IN)} \leq 13\text{ V}$			3.5	4.1	5.5	V
Vdrop_PREREG	PREREG dropout voltage	$V_{I(IN)} = 3\text{ V}$					0.1	V

VREG UVLO

PARAMETER	TEST CONDITIONS	MIN	TYP	MAX	UNIT	
$V_{OT}(\text{UVLO}_{\text{start}})$	Output threshold voltage, start	2.75	2.85	2.95	V	
$V_{OT}(\text{UVLO}_{\text{stop}})$	Output threshold voltage, stop	2.65	2.78		V	
$V_{\text{hys}}(\text{UVLO})$	Hysteresis	50	75		mV	
	UVLO sink current, GATE	$V_{I}(\text{GATE}) = 2\text{ V}$			10	mA



TPS2330, TPS2331
SINGLE HOT SWAP POWER CONTROLLER WITH
CIRCUIT BREAKER AND POWER-GOOD REPORTING

SLVS277A – MARCH 2000– REVISED APRIL 2000

electrical characteristics over recommended operating temperature range ($-40^{\circ}\text{C} < T_A < 85^{\circ}\text{C}$),
 $3\text{ V} \leq V_{I(IN1)} \leq 13\text{ V}$, $3\text{ V} \leq V_{I(IN2)} \leq 5.5\text{ V}$ (unless otherwise noted) (continued)

PWRGD

PARAMETER		TEST CONDITIONS	MIN	TYP	MAX	UNIT
$V_{IT}(ISENSE)$	Trip threshold, VSENSE	$V_I(VSENSE)$ decreasing	1.2	1.225	1.25	V
V_{hys}	Hysteresis voltage, power-good comparator		20	30	40	mV
$V_{O(sat)}(PWRGD)$	Output saturation voltage PWRGD	$I_O = 2\text{ mA}$		0.2	0.4	V
$V_{O(VREGmin)}$	Minimum $V_{O(VREG)}$ for valid power-good	$I_O = 100\text{ }\mu\text{A}$, $V_{O(PWRGD)} = 1\text{ V}$			1	V
I_{IB}	Input bias current, power-good comparator	$V_I(VSENSE) = 5.5\text{ V}$			1	μA
$I_{lkg}(PWRGD)$	Leakage current, PWRGD	$V_{O(PWRGD)} = 13\text{ V}$			1	μA
t_{dr}	Delay time, rising edge, PWRGD	$V_I(VSENSE)$ increasing, Overdrive = 20 mV, $t_r = 100\text{ ns}$, See Note 2		25		μs
t_{df}	Delay time, falling edge, PWRGD	$V_I(VSENSE)$ decreasing, Overdrive = 20 mV, $t_f = 100\text{ ns}$, See Note 2		2		μs

NOTE 2: Specified, but not production tested.

FAULT output

PARAMETER		TEST CONDITIONS	MIN	TYP	MAX	UNIT
$V_{O(sat)}(FAULT)$	Output saturation voltage, FAULT	$I_O = 2\text{ mA}$			0.4	V
$I_{lkg}(FAULT)$	Leakage current, FAULT	$V_{O(FAULT)} = 13\text{ V}$			1	μA

DISCH

PARAMETER		TEST CONDITIONS	MIN	TYP	MAX	UNIT
I_{DISCH}	Discharge current, DISCH	$V_I(DISCH) = 1.5\text{ V}$, $V_I(VIN) = 5\text{ V}$	5	10		mA
$V_{IH}(DISCH)$	Discharge on high-level input voltage		2			V
$V_{IL}(DISCH)$	Discharge on low-level input voltage				1	V



TPS2330, TPS2331
SINGLE HOT SWAP POWER CONTROLLER WITH
CIRCUIT BREAKER AND POWER-GOOD REPORTING

SLVS277A – MARCH 2000– REVISED APRIL 2000

PARAMETER MEASUREMENT INFORMATION

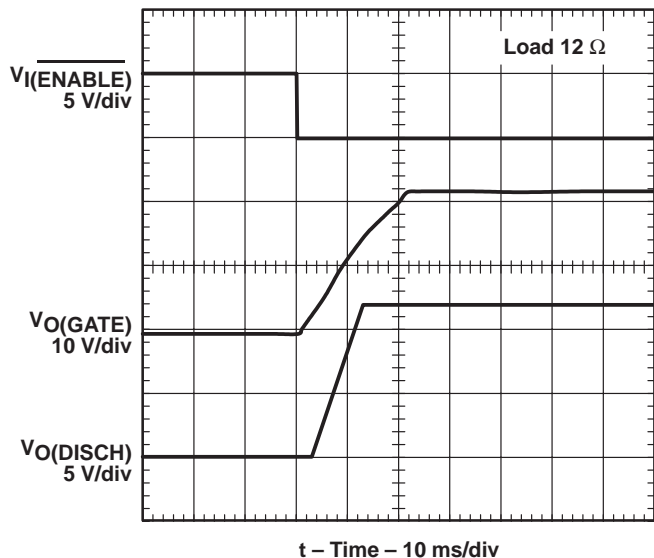

Figure 1. Turnon Voltage Transition

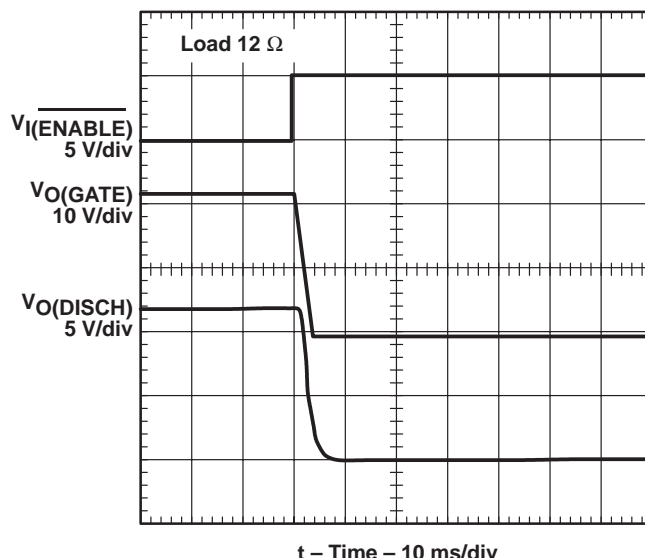

Figure 2. Turnoff Voltage Transition

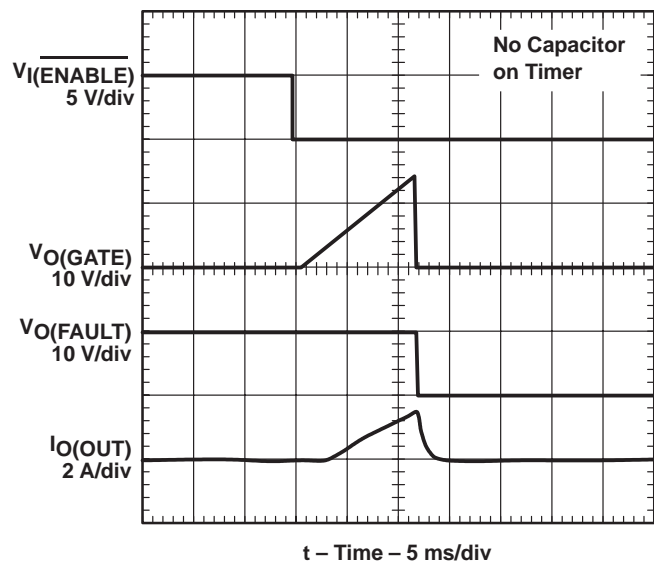

Figure 3. Overcurrent Response: Enabled Into Overcurrent Load

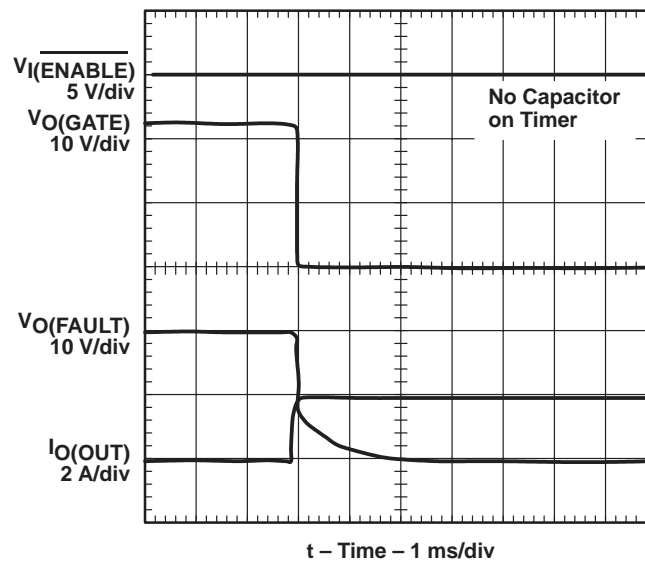

Figure 4. Overcurrent Response: an Overcurrent Load Plugged Into the Enabled Board

PARAMETER MEASUREMENT INFORMATION

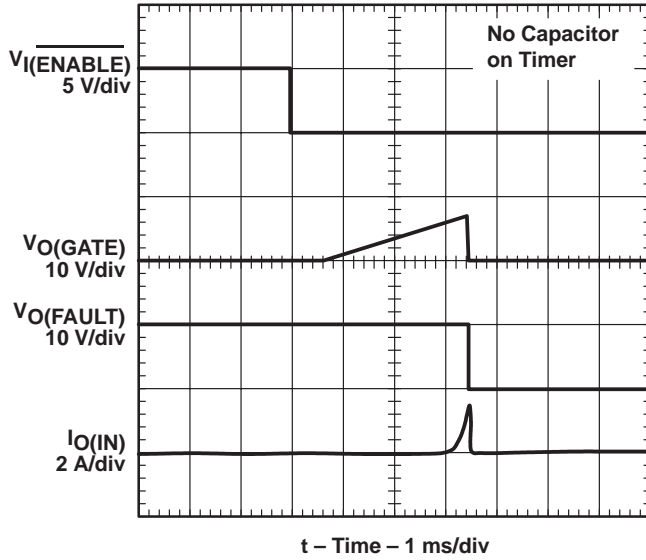

Figure 5. Enabled Into Short Circuit

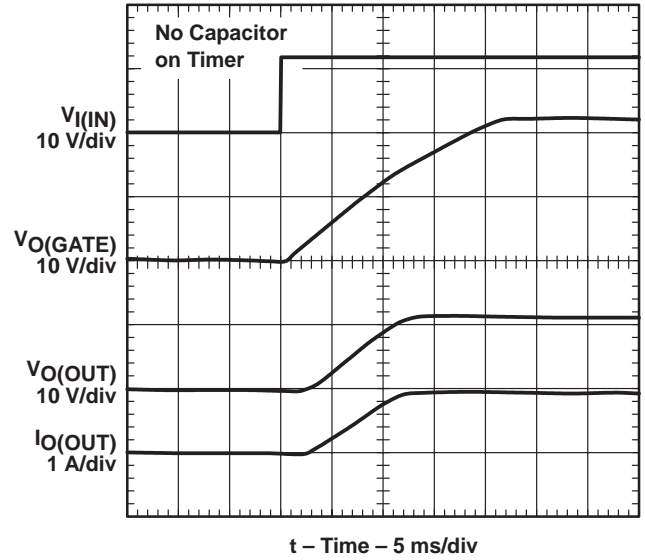

Figure 6. Hot Plug

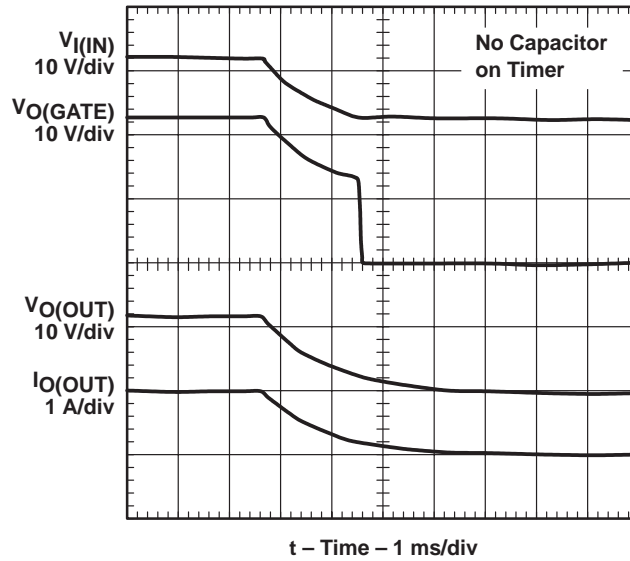

Figure 7. Hot Removal

TYPICAL CHARACTERISTICS

SUPPLY CURRENT (ENABLED)
 vs
 VOLTAGE

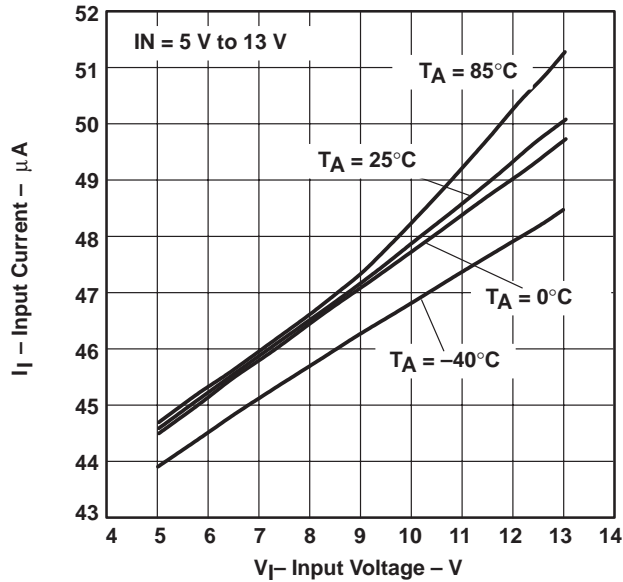

Figure 8

SUPPLY CURRENT (DISABLED)
 vs
 VOLTAGE

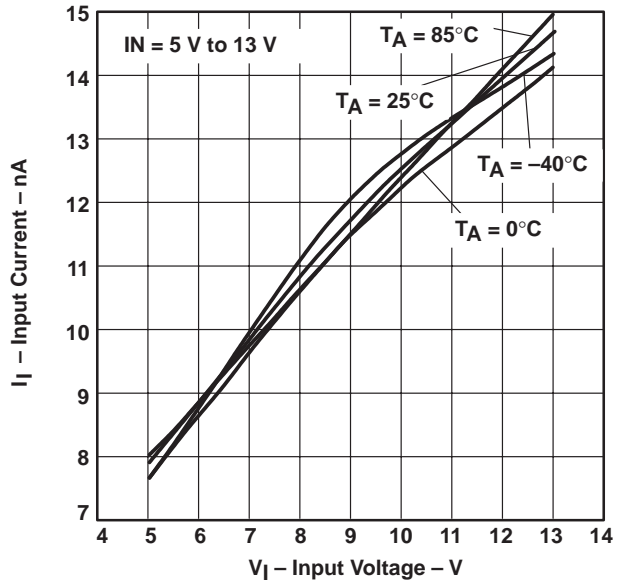

Figure 9

GATE VOLTAGE
 vs
 INPUT VOLTAGE

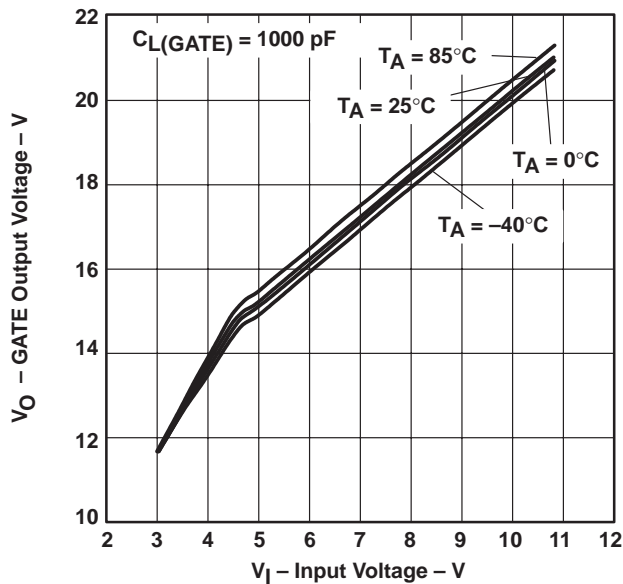

Figure 10

GATE VOLTAGE RISE TIME
 vs
 GATE LOAD CAPACITANCE

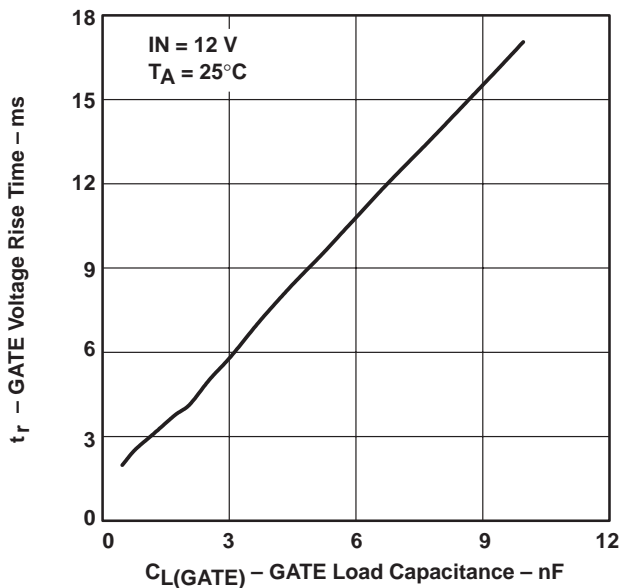

Figure 11

TYPICAL CHARACTERISTICS

GATE VOLTAGE FALL TIME
 VS
 GATE LOAD CAPACITANCE

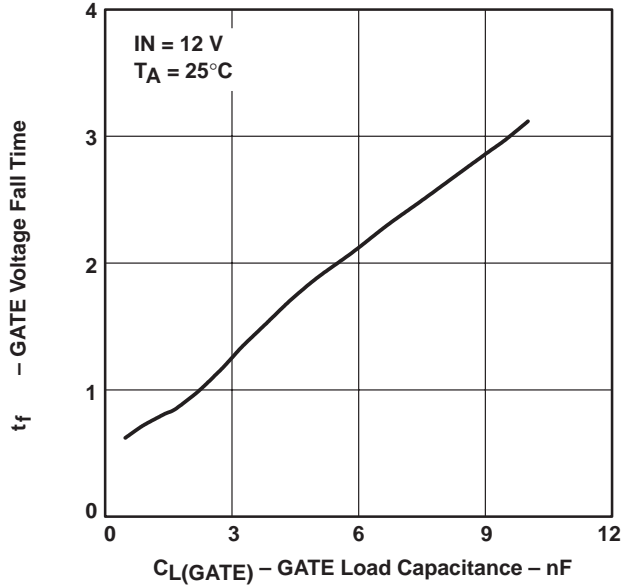

Figure 12

GATE OUTPUT CURRENT
 VS
 GATE VOLTAGE

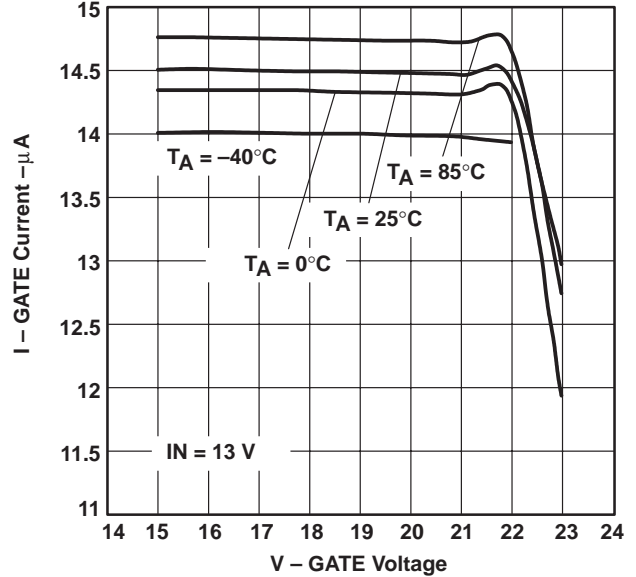

Figure 13

CIRCUIT-BREAKER RESPONSE
 VS
 TIMER CAPACITANCE

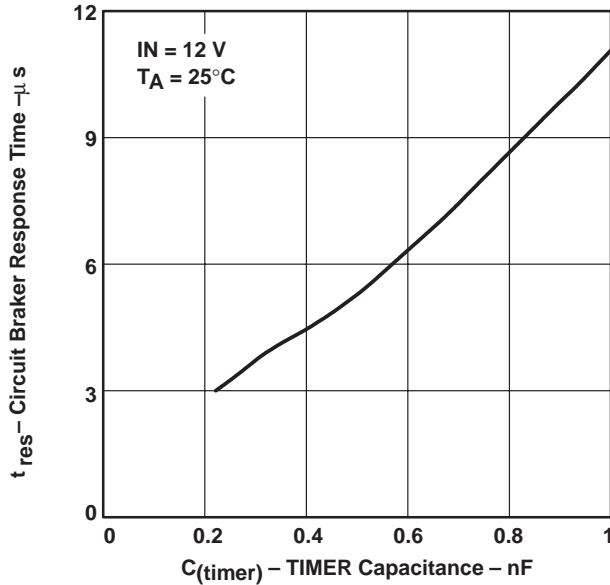

Figure 14

LOAD VOLTAGE DISCHARGE TIME
 VS
 LOAD CAPACITANCE

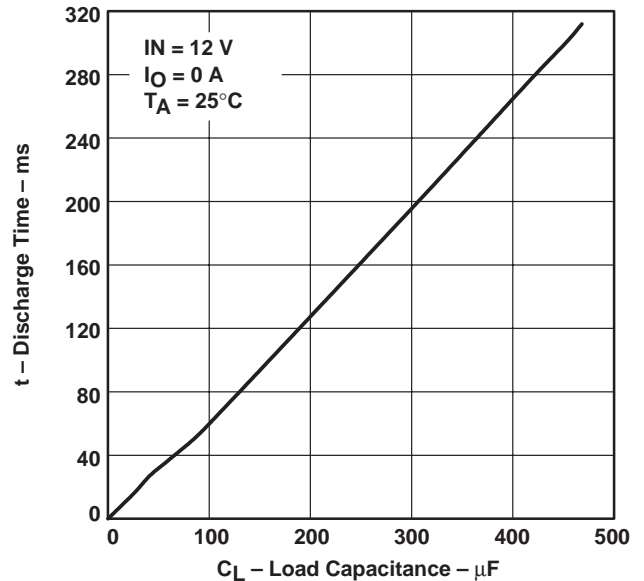

Figure 15

TPS2330, TPS2331
SINGLE HOT SWAP POWER CONTROLLER WITH
CIRCUIT BREAKER AND POWER-GOOD REPORTING

SLVS277A – MARCH 2000– REVISED APRIL 2000

TYPICAL CHARACTERISTICS

UVLO START AND STOP THRESHOLDS
VS
TEMPERATURE

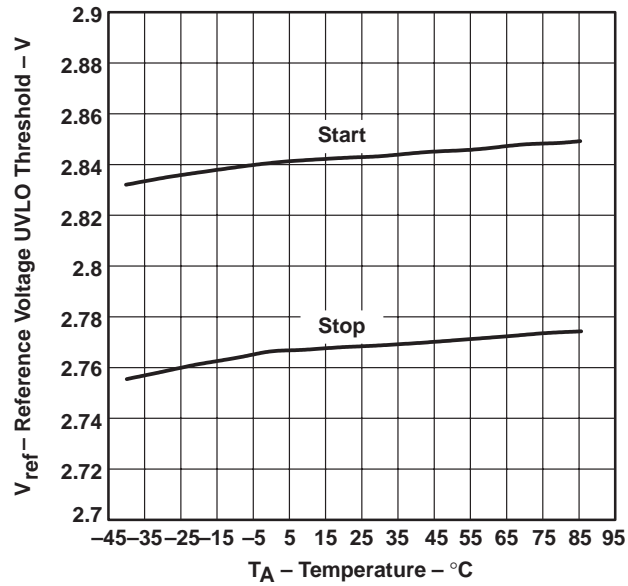

Figure 16

PWRGD THRESHOLD
VS
TEMPERATURE

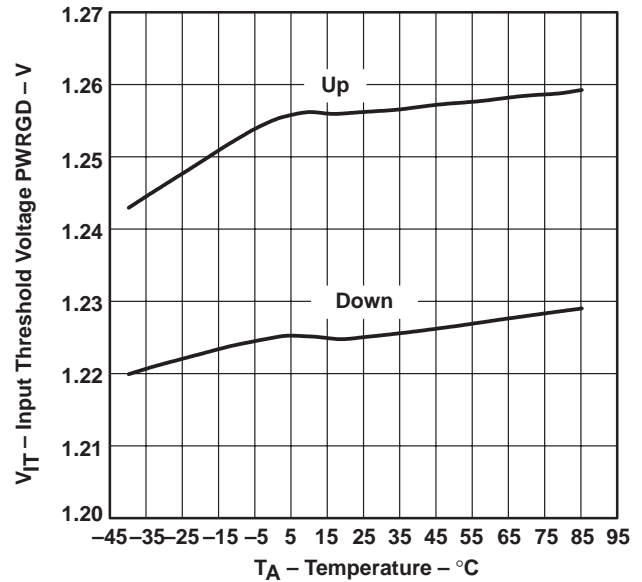

Figure 17

TPS2330, TPS2331 SINGLE HOT SWAP POWER CONTROLLER WITH CIRCUIT BREAKER AND POWER-GOOD REPORTING

SLVS277A – MARCH 2000– REVISED APRIL 2000

APPLICATION INFORMATION

Table 1. Some Available N-Channel MOSFETs

CURRENT RANGE (A)	PART NUMBER	DESCRIPTION	MANUFACTURER
0 to 2	IRF7601	N-channel, $r_{DS(on)} = 0.035 \Omega$, 4.6 A, Micro-8	International Rectifier
	MTSF3N03HDR2	N-channel, $r_{DS(on)} = 0.040 \Omega$, 4.6 A, Micro-8	ON Semiconductor
	IRF7101	Dual N-channel, $r_{DS(on)} = 0.1 \Omega$, 2.3 A, SO-8	International Rectifier
	MMSF5N02HDR2	Dual N-channel, $r_{DS(on)} = 0.04 \Omega$, 5 A, SO-8	ON Semiconductor
2 to 5	IRF7401	N-channel, $r_{DS(on)} = 0.022 \Omega$, 7 A, SO-8	International Rectifier
	MMSF5N02HDR2	N-channel, $r_{DS(on)} = 0.025 \Omega$, 5 A, SO-8	ON Semiconductor
	IRF7313	Dual N-channel, $r_{DS(on)} = 0.029 \Omega$, 5.2 A, SO-8	International Rectifier
	SI4410	N-channel, $r_{DS(on)} = 0.020 \Omega$, 8 A, SO-8	Vishay Dale
5 to 10	IRLR3103	N-channel, $r_{DS(on)} = 0.019 \Omega$, 29 A, d-Pak	International Rectifier
	IRLR2703	N-channel, $r_{DS(on)} = 0.045 \Omega$, 14 A, d-Pak	International Rectifier

timer

For most applications, a minimum capacitance of 50 pF is recommended to prevent false triggering. This capacitor should be connected between TIMER and ground. The presence of an overcurrent condition on of the TPS2330/31 causes a 50- μ A current source to begin charging this capacitor. If the overcurrent condition persists until the capacitor has been charged to approximately 0.5 V, the TPS2330/31 will latch off the transistor and will pull the FAULT pin low. The timer capacitor can be made as large as desired to provide additional time delay before registering a fault condition.

output-voltage slew-rate control

When enabled, the TPS2330/TPS2331 controllers supply the gate of an external MOSFET transistor with a current of approximately 15 μ A. The slew rate of the MOSFET source voltage is thus limited by the gate-to-drain capacitance C_{gd} of the external MOSFET capacitor to a value approximating:

$$\frac{dV_s}{dt} = \frac{15 \mu A}{C_{gd}}$$

If a slower slew rate is desired, an additional capacitance can be connected between the gate of the external MOSFET and ground.

VREG capacitor

The internal voltage regulator connected to VREG requires an external capacitor to ensure stability. A 0.1- μ F or 0.22- μ F ceramic capacitor is recommended.



APPLICATION INFORMATION

gate drive circuitry

The TPS2330/TPS2331 includes four separate features associated with each gate-drive terminal:

- A charging current of approximately 15 μA is applied to enable the external MOSFET transistor. This current is generated by an internal charge pump that can develop a gate-to-source potential (referenced to DISCH) of 9 V–12 V. DISCH must be connected to the external MOSFET source terminal to ensure proper operation of this circuitry.
- A discharge current of approximately 75 μA is applied to disable the external MOSFET transistor. Once the transistor gate voltage has dropped below approximately 1.5 V, this current is disabled and the UVLO discharge driver is enabled instead. This feature allows the part to enter a low-current shutdown mode while ensuring that the gate of the external MOSFET transistor remain at a low voltage.
- During a UVLO condition, the gate of the MOSFET transistor is pulled down by an internal PMOS transistor. This transistor continues to operate even if the voltage at IN is 0 V. This circuitry also helps hold the external MOSFET transistor off when power is suddenly applied to the system.
- During an overcurrent fault condition, the external MOSFET transistor that exhibited an over-current condition will be rapidly turned off by an internal pulldown circuit capable of pulling in excess of 400 mA (at 4 V) from the pin. Once the gate has been pulled below approximately 1.5 V, this driver is disengaged and the UVLO driver is enabled instead.

setting the current-limit circuit-breaker threshold

The current sensing resistor R_{ISENSE} and the current limit setting resistor R_{ISET} determine the current limit of the channel, and can be calculated by the following equation:

$$I_{\text{LMT}} = \frac{R_{\text{ISET}} \times 50 \times 10^{-6}}{R_{\text{ISENSE}}}$$

Typically R_{ISENSE} is usually very small (0.001 Ω to 0.1 Ω). If the trace and solder-junction resistances between the junction of R_{ISENSE} and ISENSE and the junction of R_{ISENSE} and R_{ISET} are greater than 10% of the R_{ISENSE} value, then these resistance values should be added to the R_{ISENSE} value used in the calculation above.

Table 2 shows some of the current sense resistors available in the market.

Table 2. Some Current Sense Resistors

CURRENT RANGE (A)	PART NUMBER	DESCRIPTION	MANUFACTURER
0 to 1	WSL-1206, 0.05 1%	0.05 Ω , 0.25 W, 1% resistor	Vishay Dale
1 to 2	WSL-1206, 0.025 1%	0.025 Ω , 0.25 W, 1% resistor	
2 to 4	WSL-1206, 0.015 1%	0.015 Ω , 0.25 W, 1% resistor	
4 to 6	WSL-2010, 0.010 1%	0.010 Ω , 0.5 W, 1% resistor	
6 to 8	WSL-2010, 0.007 1%	0.007 Ω , 0.5 W, 1% resistor	
8 to 10	WSR-2, 0.005 1%	0.005 Ω , 0.5 W, 1% resistor	

TPS2330, TPS2331 SINGLE HOT SWAP POWER CONTROLLER WITH CIRCUIT BREAKER AND POWER-GOOD REPORTING

SLVS277A – MARCH 2000– REVISED APRIL 2000

APPLICATION INFORMATION

setting the power-good threshold voltage

The two feedback resistors R_{VSENSE_TOP} and R_{VSENSE_BOT} connected between V_O and ground form a resistor divider setting the voltage at the $VSENSE$ pins. $VSENSE$ voltage equals to

$$V_{I(SENSE)} = V_O \times R_{VSENSE_BOT} / (R_{VSENSE_TOP} + R_{VSENSE_BOT})$$

This voltage is compared to an internal voltage reference ($1.225\text{ V} \pm 2\%$) to determine whether the output voltage level is within a specified tolerance. For example, given a nominal output voltage at V_O , and defining V_{O_min} as the minimum required output voltage, then the feedback resistors are defined by:

$$R_{VSENSE_TOP} = \frac{V_{O_min} - 1.225}{1.225} \times R_{VSENSE_BOT}$$

Start the process by selecting a large standard resistor value for R_{VSENSE_BOT} to reduce power loss. Then R_{VSENSE_TOP} can be calculated by inserting all of the known values into the equation above. When V_O is lower than V_{O_min} , $PWRGD$ will be low as long as the controller is enabled.

undervoltage lockout (UVLO)

The TPS2330/TPS2331 includes an undervoltage lockout (UVLO) feature that monitors the voltage present on the $VREG$ pin. This feature will disable the external MOSFET if the voltage on $VREG$ drops below 2.78 V (nominal) and will re-enable normal operation when it rises above 2.85 V (nominal). Since $VREG$ is fed from IN through a low-dropout voltage regulator, the voltage on $VREG$ will track the voltage on IN within 50 mV. While the undervoltage lockout is engaged, $GATE$ is held low by an internal PMOS pulldown transistor, ensuring that the external MOSFET transistor remain off at the times, even if the power supply has fallen to 0 V.

power-up control

The TPS2330/TPS2331 includes a 500 μs (nominal) startup delay that ensures that internal circuitry has sufficient time to start before the device begins turning on the external MOSFETs. This delay is triggered only upon the rapid application of power to the circuit. If the power supply ramps up slowly, the undervoltage lockout circuitry will provide adequate protection against undervoltage operation.

3-channel hot-swap application

Some applications require hot-swap control of up to three voltage rails, but may not explicitly require the sensing of the status of the output power on all three of the voltage rails. One such application is device bay, where dv/dt control of 3.3 V, 5 V, and 12 V is required. By using TPS2330/TPS2331 to drive all three power rails, as is shown below, TPS2330/31 can deliver three different voltages to three loads while monitoring the status of one of the loads.



POST OFFICE BOX 655303 • DALLAS, TEXAS 75265

APPLICATION INFORMATION

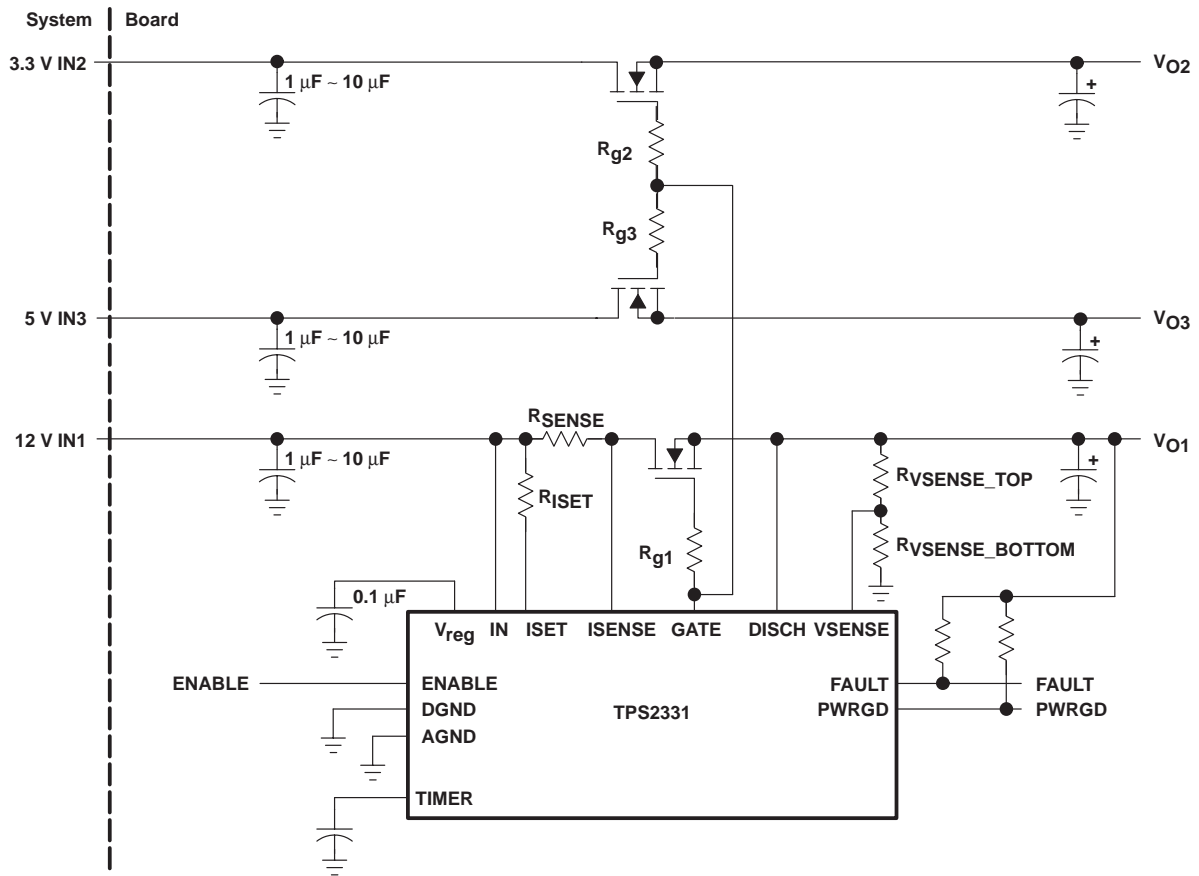

Figure 19. Three-Channel Application

Figure 29 shows ramp-up waveforms of the three output voltages.

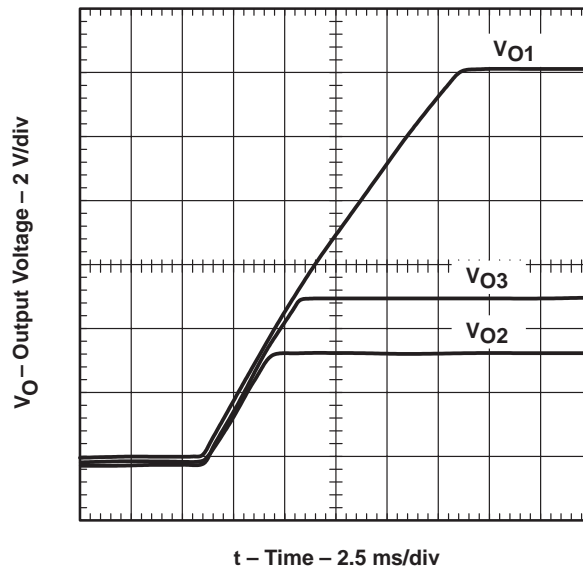

Figure 20

TPS2330, TPS2331
SINGLE HOT SWAP POWER CONTROLLER WITH
CIRCUIT BREAKER AND POWER-GOOD REPORTING

SLVS277A – MARCH 2000– REVISED APRIL 2000

MECHANICAL DATA

D (R-PDSO-G)**

PLASTIC SMALL-OUTLINE PACKAGE

14 PINS SHOWN

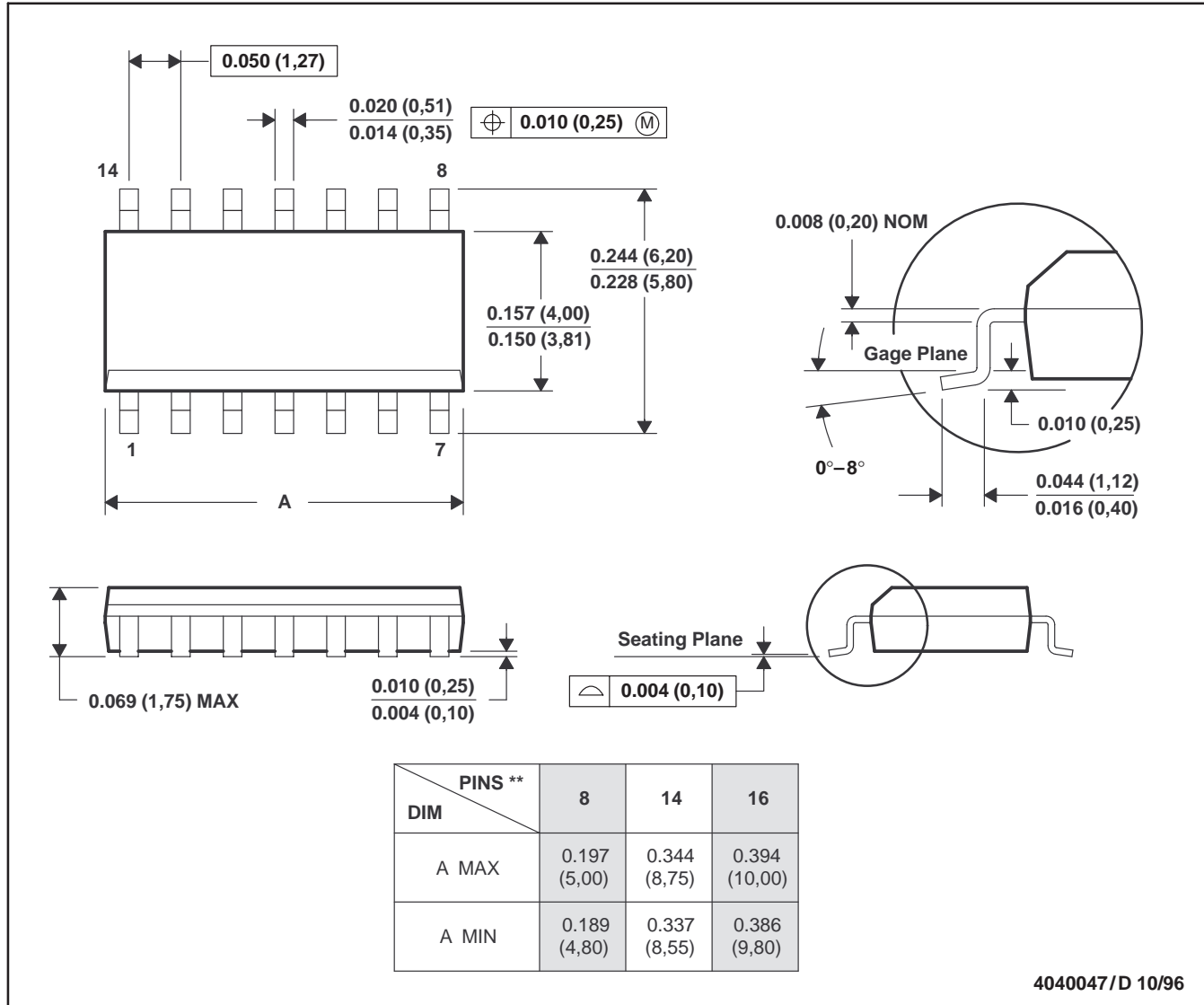

- NOTES: A. All linear dimensions are in inches (millimeters).
 B. This drawing is subject to change without notice.
 C. Body dimensions do not include mold flash or protrusion, not to exceed 0.006 (0,15).
 D. Falls within JEDEC MS-012

TPS2330, TPS2331
SINGLE HOT SWAP POWER CONTROLLER WITH
CIRCUIT BREAKER AND POWER-GOOD REPORTING

SLVS277A – MARCH 2000– REVISED APRIL 2000

MECHANICAL DATA

PW (R-PDSO-G)**

PLASTIC SMALL-OUTLINE PACKAGE

14 PINS SHOWN

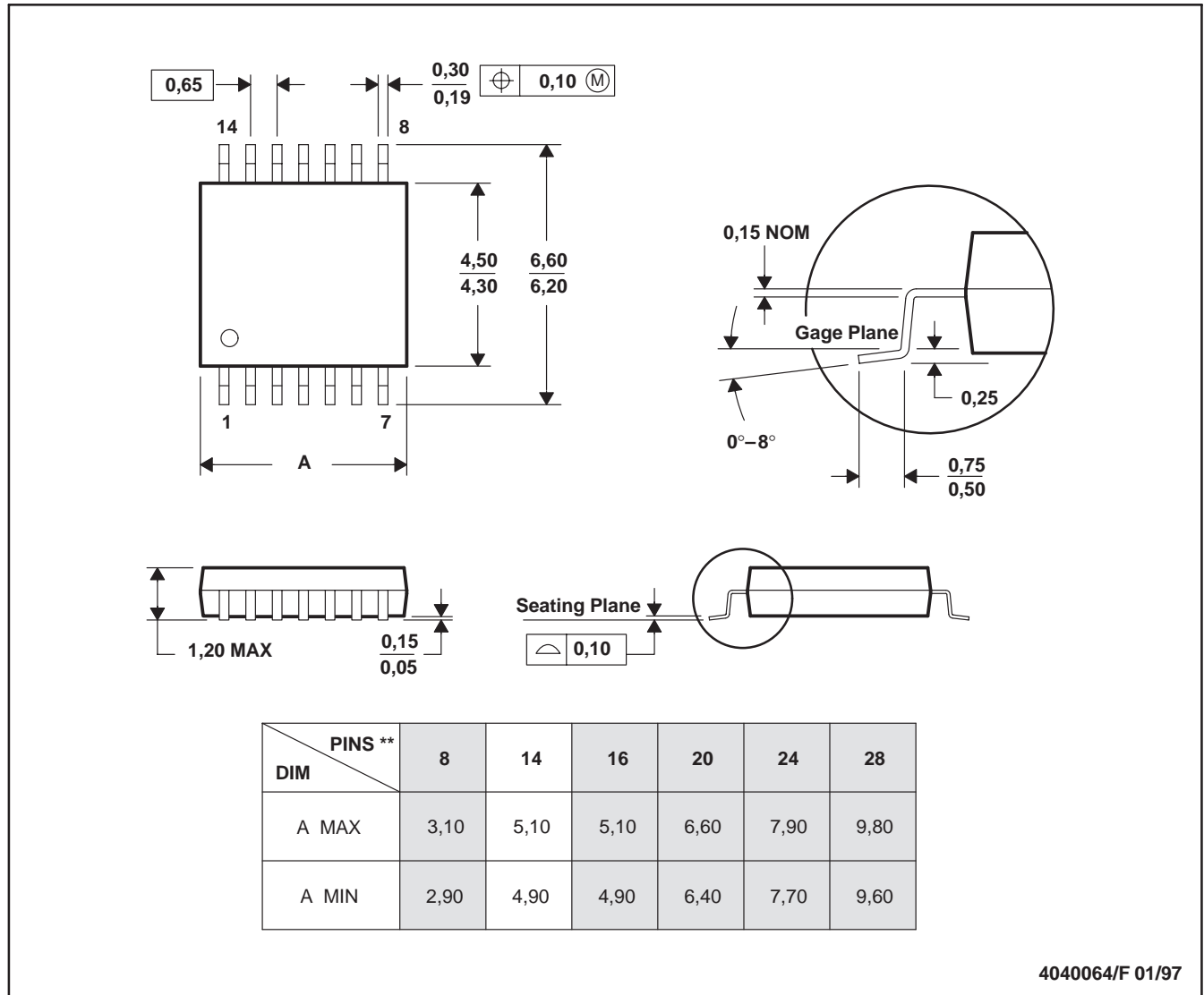

- NOTES: A. All linear dimensions are in millimeters.
 B. This drawing is subject to change without notice.
 C. Body dimensions do not include mold flash or protrusion not to exceed 0,15.
 D. Falls within JEDEC MO-153

IMPORTANT NOTICE

Texas Instruments and its subsidiaries (TI) reserve the right to make changes to their products or to discontinue any product or service without notice, and advise customers to obtain the latest version of relevant information to verify, before placing orders, that information being relied on is current and complete. All products are sold subject to the terms and conditions of sale supplied at the time of order acknowledgment, including those pertaining to warranty, patent infringement, and limitation of liability.

TI warrants performance of its semiconductor products to the specifications applicable at the time of sale in accordance with TI's standard warranty. Testing and other quality control techniques are utilized to the extent TI deems necessary to support this warranty. Specific testing of all parameters of each device is not necessarily performed, except those mandated by government requirements.

Customers are responsible for their applications using TI components.

In order to minimize risks associated with the customer's applications, adequate design and operating safeguards must be provided by the customer to minimize inherent or procedural hazards.

TI assumes no liability for applications assistance or customer product design. TI does not warrant or represent that any license, either express or implied, is granted under any patent right, copyright, mask work right, or other intellectual property right of TI covering or relating to any combination, machine, or process in which such semiconductor products or services might be or are used. TI's publication of information regarding any third party's products or services does not constitute TI's approval, warranty or endorsement thereof.