

TV SOUND CHANNEL WITH DC CONTROLS

- SEPARATE VCR INPUT AND OUTPUT PINS
- 4W OUTPUT POWER INTO 16Ω
- NO SCREENING REQUIRED
- HIGH SENSITIVITY
- EXCELLENT AM REJECTION
- LOW DISTORTION
- DC TONE/VOLUME CONTROLS
- THERMAL PROTECTION

DESCRIPTION

The TDA8190 is a complete TV sound channel with DC tone and volume controls plus separate VCR input and output connections. Mounted in a Powerdip 16 + 2 + 2 package, the device delivers an output power of 4W into 16Ω (d = 10%, $V_s = 24V$) or 1.5W into 8Ω (d = 10%, $V_s = 12V$). Included in the TDA8190 are : IF amplifier limiter, active low-pass filter, AF pre-amplifier and power amplifier, turn-off muting, mute circuit and thermal protection. High output, high sensitivity, excellent AM rejection and low distortion make the device suitable for use in TVs of almost every type. Further, no screening is necessary because the device is free of radiation problems.

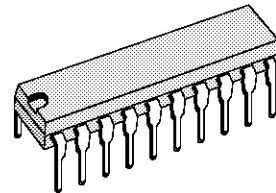

DIP20
(Plastic Package)

ORDER CODE : TDA8190

PIN CONNECTIONS

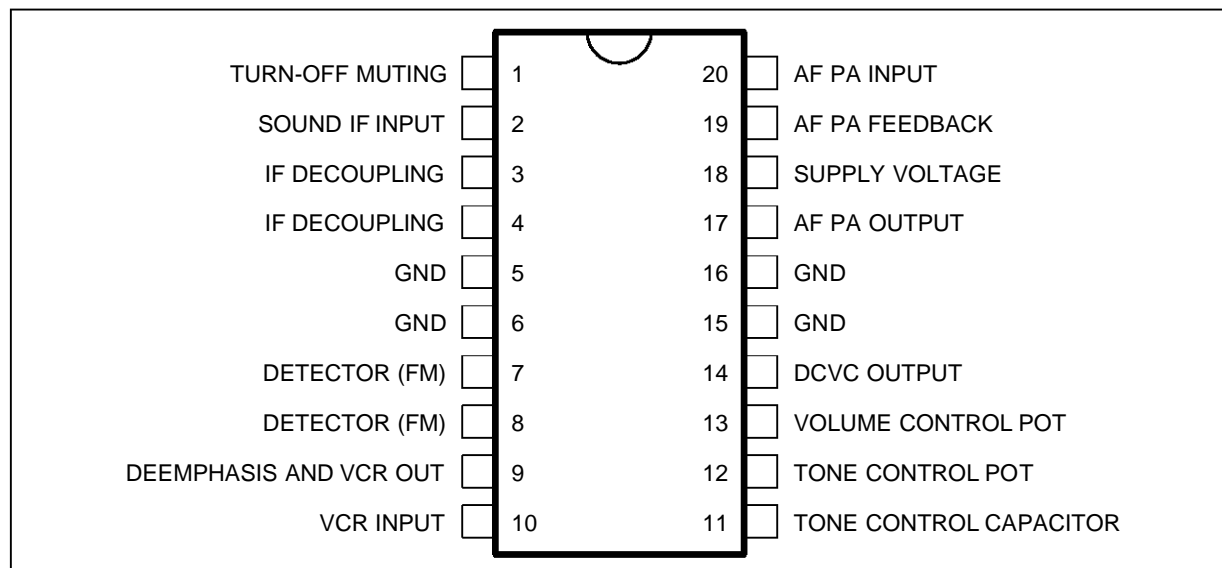

8190-01.EPS

BLOCK DIAGRAM

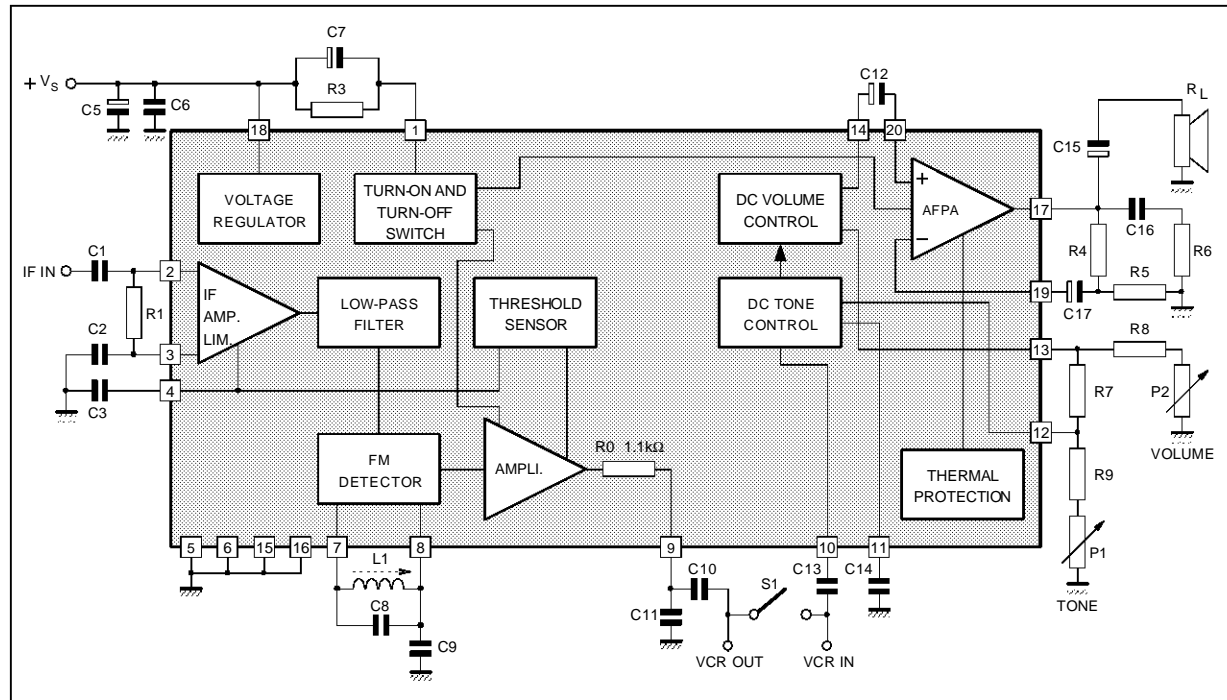

8190-02.EPS

ABSOLUTE MAXIMUM RATINGS

Symbol	Parameter	Value	Unit
V_s	Supply Voltage (pin 18)	28	V
V_1	Voltage at Pin 1	$\pm V_s$	
V_i	Input Voltage (pin 2)	1	V_{pp}
I_o	Output Peak Current (repetitive)	1.5	A
I_o	Output Peak Current (non repetitive)	2	A
I_4	Current (pin 4)	10	mA
P_{tot}	Power Dissipation : at $T_{pins} = 90\text{ }^\circ\text{C}$ at $T_{amb} = 70\text{ }^\circ\text{C}$	4.3 1	W W
$T_{stg} - T_j$	Storage and Junction Temperature	- 40 to 150	$^\circ\text{C}$

8190-01.TBL

THERMAL DATA

Symbol	Parameter	Value	Unit
$R_{th\ j-pins}$	Thermal Resistance Junction-pins Max.	14	$^\circ\text{C/W}$
$R_{th\ j-amb}$	Thermal Resistance Junction-ambient Max.	80	$^\circ\text{C/W}^*$

(*) Obtained with GND pins soldered to printed circuit with minimized copper area.

8190-02.TBL

ELECTRICAL CHARACTERISTICS

(refer to the test circuit, $V_S = 24V$, $S1 : on$, $\Delta f = \pm 25kHz$, $V_i = 1mV$, $P_1 = 12k\Omega$, $f_0 = 4.5MHz$, $f_m = 400Hz$, $T_{amb} = 25^\circ C$, unless otherwise specified)

Symbol	Parameter	Test Conditions	Min.	Typ.	Max.	Unit
--------	-----------	-----------------	------	------	------	------

DC CHARACTERISTICS

V_S	Supply Voltage (pin 18)	$P_2 = 12k\Omega$	10.8		27	V
V_o	Quiescent Output Voltage (pin 17)		11	12	13	
V_1	Pin 1 DC Voltage	$P_2 = 12k\Omega$, $R_1 = 270k\Omega$		5.3		V
V_4	Pin 4 DC Voltage	$P_2 = 12k\Omega$		3.2		V
I_d	Quiescent Drain Current			32		mA

IF AMPLIFIER AND DETECTOR

$V_{i(\text{threshold})}$	Input Limiting Voltage at Pin 2 (-3dB)	$V_o = 4 V_{rms}$		50	100	μV
V_9	Recovered Audio Voltage (pin 9)	$\Delta f = \pm 7.5kHz$, $P_2 = 12k\Omega$	140	200	280	mV
AMR	Amplitude Modulation Rejection (*)	$m = 0.3$, $V_i = 1mV$, $V_o = 4V_{RMS}$		60		dB
R_i	Input Resistance (pin 2)	$\Delta f = 0$, $P_2 = 12k\Omega$		30		k Ω
C_i	Input Capacitance (pin 2)		6		pF	
R_9	Deemphasis Resistance	$C_1 = 68$ to $888nF$	0.75	1.1	1.5	k Ω

DC VOLUME CONTROL

K_v	Volume Attenuation (resistance control)	$P_2 = 0\Omega$ $P_2 = 4.3k\Omega$ $P_2 = 12k\Omega$	20	0 26 88	32	dB dB dB
V_c	Control Voltage	$K = 0dB$ $K = 26dB$ $K = 88dB$		0 1.3 2.6		V V V
$\frac{\Delta K_v}{\Delta T_{pins}}$	Volume Attenuation Thermal Drift (resistance control)	$T_{pins} = 25$ to $85^\circ C$, $P_2 = 4.3k\Omega$		-0.05		dB/ $^\circ C$

DC TONE CONTROL

K_T	Tone Cut	$S1 : Off$, $V_{10} = 200 mV$ $P_1 = 12k\Omega$ to 100Ω , $f_{AF} = 10kHz$		14		dB
-------	----------	---	--	----	--	----

AUDIO FREQUENCY AMPLIFIER

P_o	Output Power (d = 10 %)	$V_S = 24 V$, $R_L = 16 \Omega$ $V_S = 12 V$, $R_L = 8 \Omega$	3.5	4.1 1.5		W W
B	Frequency Response of Audio Amplifier (-3dB)	$P_o = 1W$, $R_L = 16\Omega$, $S1 : Off$, $V_{10} = 200mV$, $V_o = 4V_{RMS}$, @400 Hz	15	50		kHz
SVR	Supply Voltage Rejection	$P_2 = 12k\Omega$, $\Delta f = 0$, $f_{ripple} = 120Hz$		26		dB

V. C. R.

d	Total Harmonic Distortion of Pin 9 Output Signal	$\Delta f = \pm 7.5kHz$, $V_i = 1mV$		0.5		%
SVR	Supply Voltage Rejection at Output Pin 9	$\Delta f = 0$, $f_{ripple} = 120Hz$, $P_2 = 12k\Omega$		66		dB
$\frac{S+N}{N}$	Signal to Noise Ratio at Output Pin 9	$\Delta f = 25 kHz$, $V_i \geq 1 mV$		70		dB
V_{10}	Input Voltage (playback)	$V_o = 4 V_{rms}$, $P_2 = 0$, $S1 : Off$	50	70	100	mV
R_{10}	Input Resistance (playback)	$S1 : Off$	10			k Ω
	Total Harmonic Distortion for 20dB Overload of V_{10}	$S1 : Off$, $V_{10} = 1V_{rms}$, $V_o = 4V_{rms}$		0.5	3	%

8190-03.TBL

TDA8190

ELECTRICAL CHARACTERISTICS (continued)

(refer to the test circuit, $V_S = 24V$, S1 : on, $\Delta f = \pm 25kHz$, $V_i = 1mV$, $P_1 = 12k\Omega$, $f_o = 4.5MHz$, $f_m = 400Hz$, $T_{amb} = 25^\circ C$, unless otherwise specified).

Symbol	Parameter	Test Conditions	Min.	Typ.	Max.	Unit
$\frac{S+N}{N}$	Signal to Noise Ratio (*)	$V_i \geq 1mV$, $V_o = 4V_{rms}$, $\Delta f = 0$		70		dB
d	Distortion (*)	$P_o = 50mW$, $\Delta f = \pm 7.5Hz$ $V_S = 24V$ $R_L = 16\Omega$ $V_S = 12V$ $R_L = 8\Omega$		0.5 0.5		% %
M	Muting (*)	$V_o = 4V_{rms}$ @ no V_1 ; $V_1 = 0$	100			dB
Δf	Deviation Sensitivity	$P_2 = 0$, $V_o = 4V_{rms}$		3	6	kHz

* Test Bandwidth = 20kHz.

TEST CIRCUIT

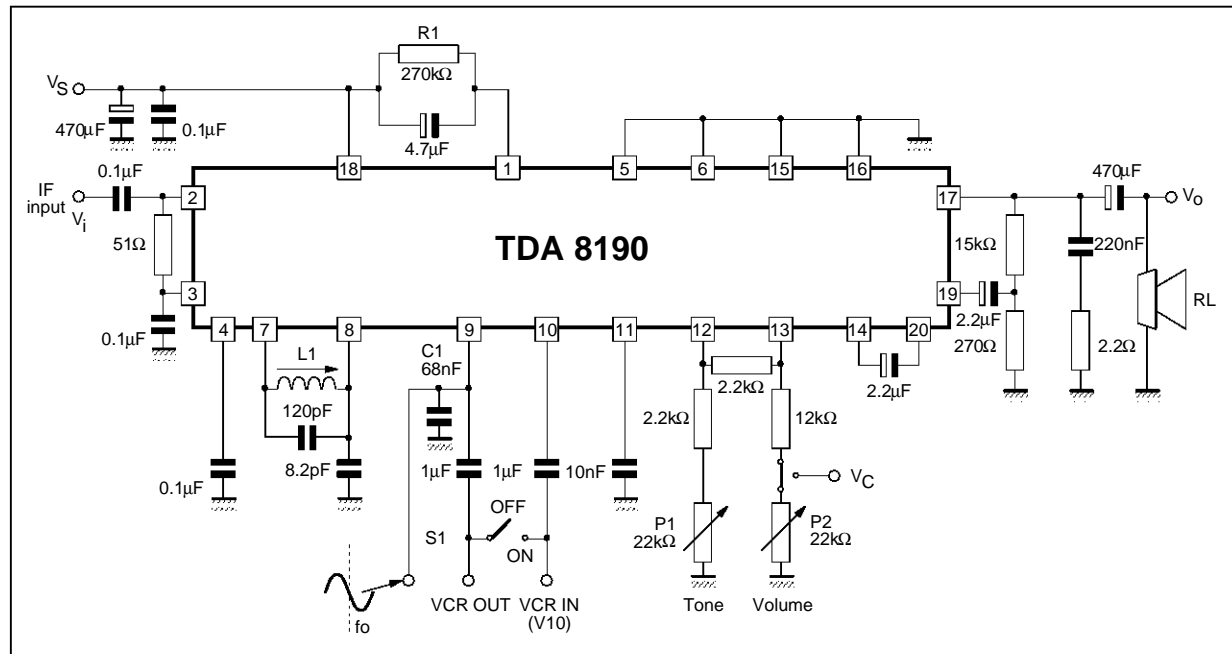

TEST CONDITIONS (unless otherwise specified)

$V_S = 24V$, $Q_0 = 60$, $f_0 = 4.5MHz$, $V_{IN} = 1mV$, $f_m = 400Hz$, $\Delta f = \pm 25kHz$, $P_1 = 12k\Omega$, $R_L = \infty$, $S1 = on$

Figure 1 : Relative Audio Output Voltage and Output Noise versus Input Signal

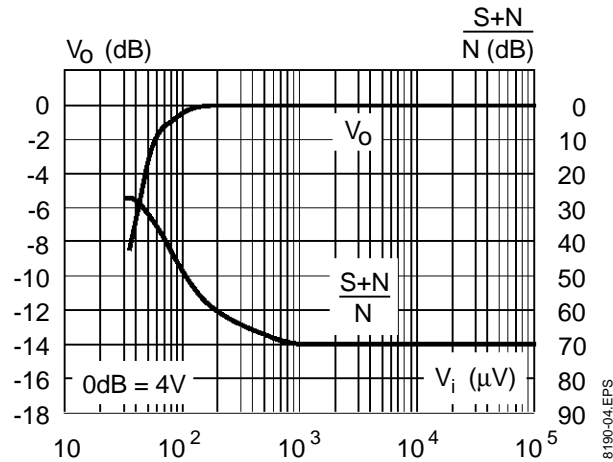

Figure 2 : Output Voltage Alternation versus DC Volume Control Resistance (a) or versus DC Volume Control Voltage (b)

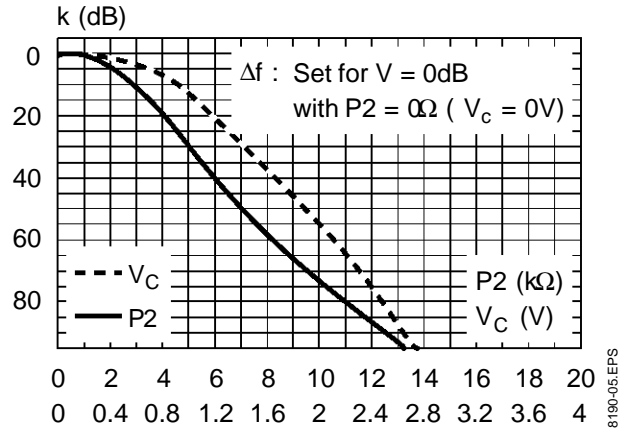

Figure 3 : DC Tone Control Cut-off the High Audio Frequencies for some Values of Resistance adjusted by P1

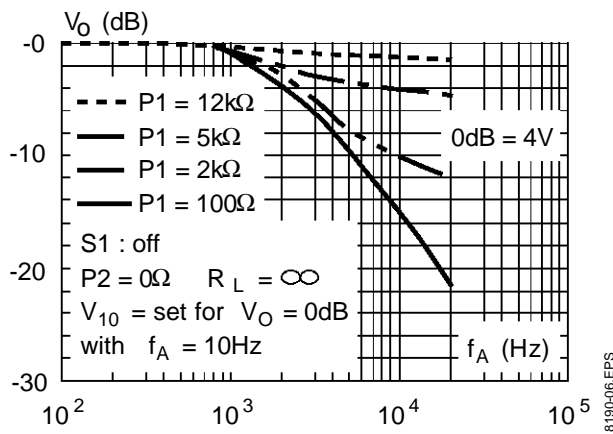

Figure 4 : Amplitude Modulation Rejection versus Input Signal

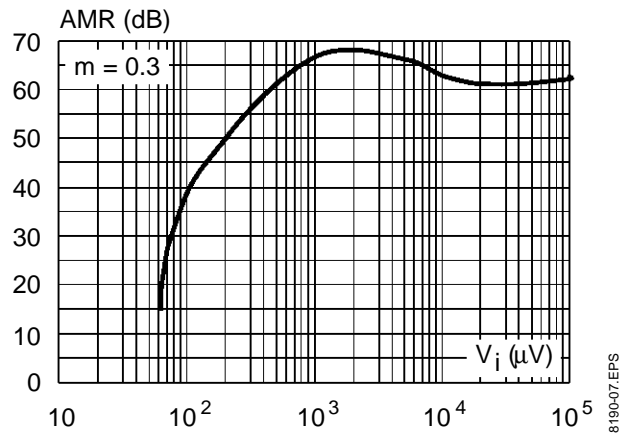

Figure 5 : ΔAMR versus Timing Frequency Change

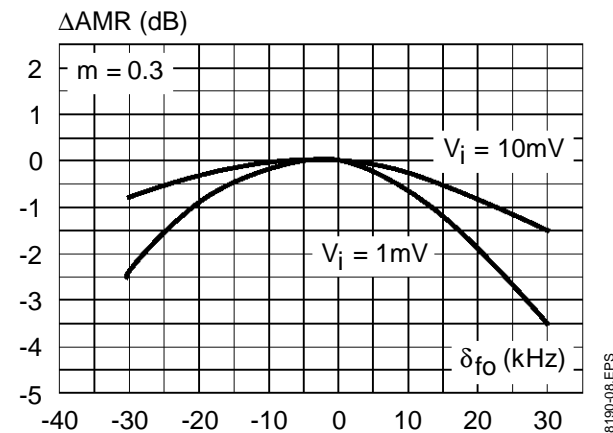

Figure 6 : Recovered Audio Voltage versus Un-loaded Q-factor of the Detector Coil

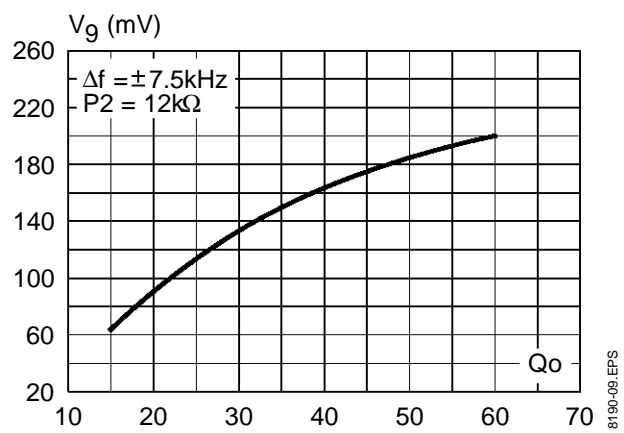

Figure 7 : Distortion versus Unloaded Q-factor of the Detector Coil

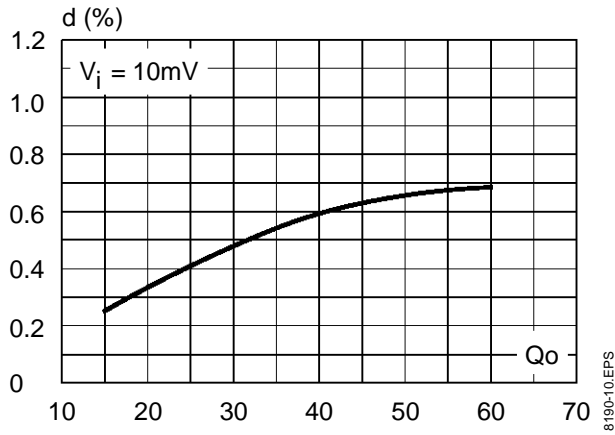

Figure 9 : Distortion versus Tuning Frequency Change

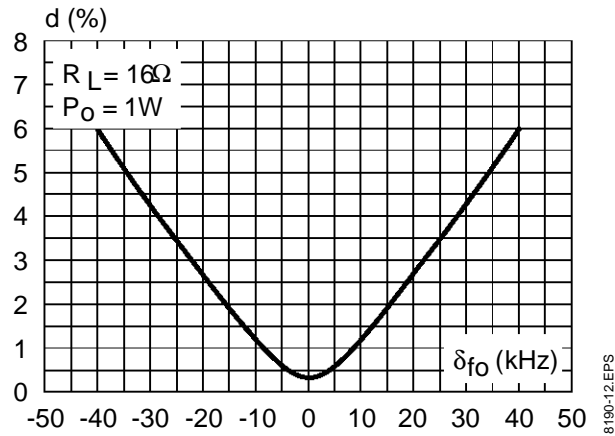

Figure 11 : Audio Amplifier Frequency Response

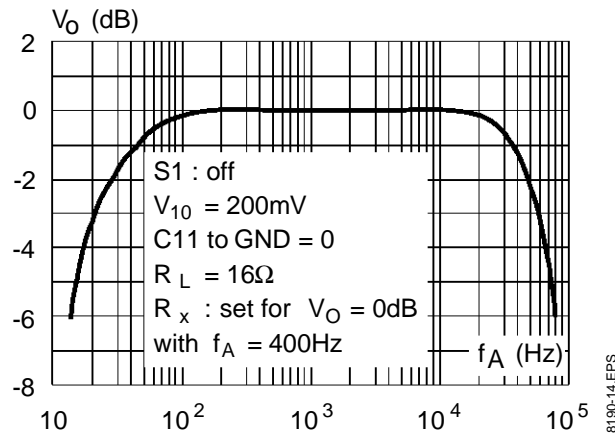

Figure 8 : Distortion versus Frequency Variation

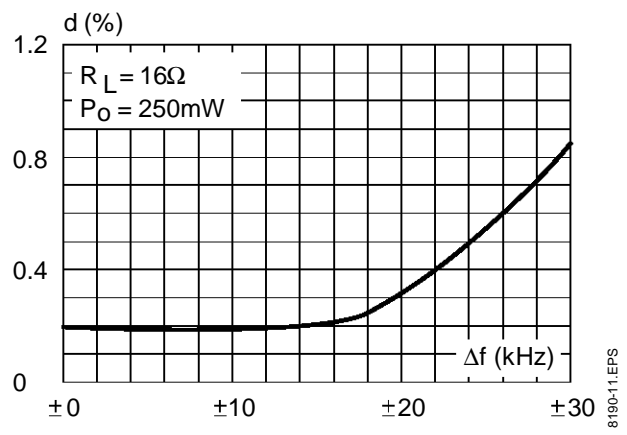

Figure 10 : Distortion versus Output Power

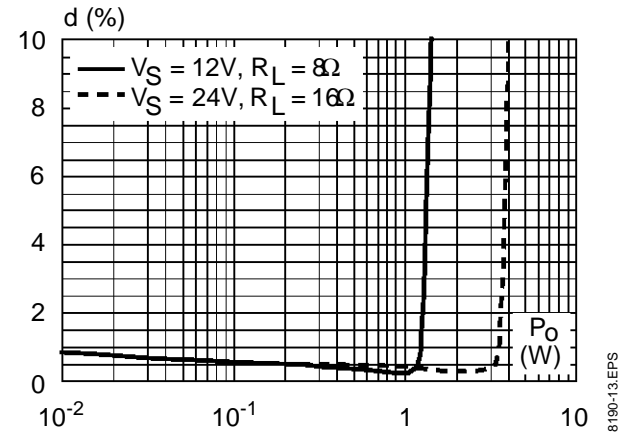

Figure 12 : Output Power versus Supply Voltage

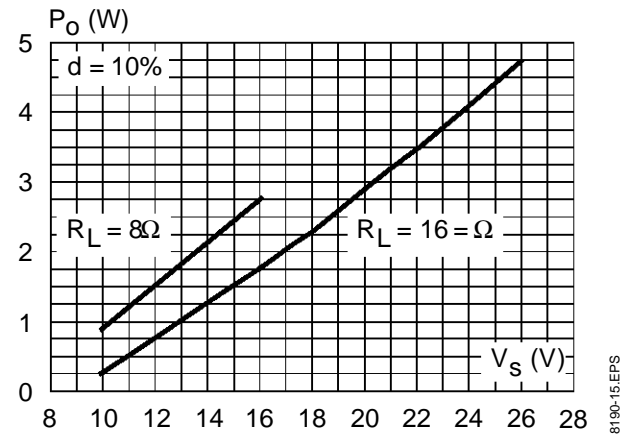

Figure 13 : Power Dissipation versus Supply Voltage (sine wave operation)

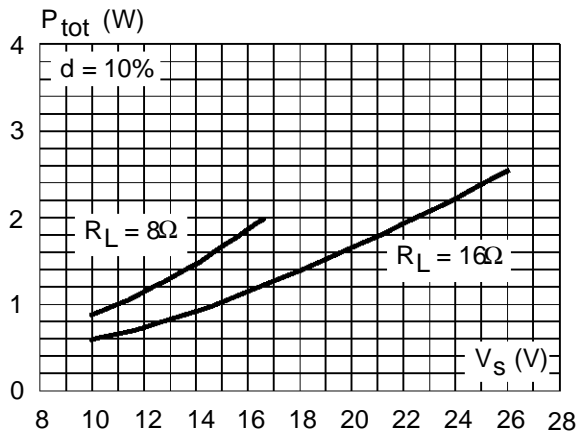

Figure 14 : Power Dissipation and Efficiency versus Output Power

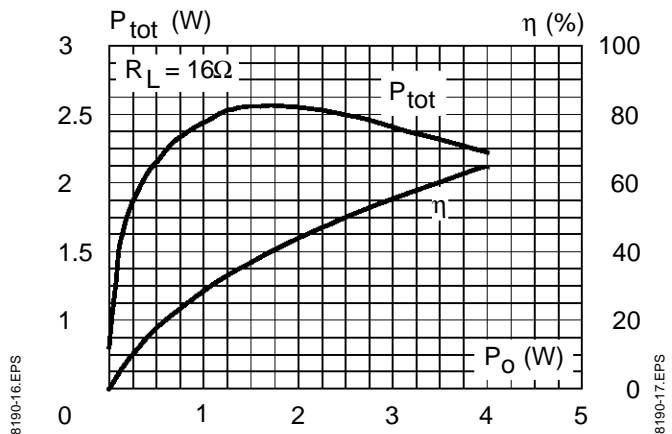
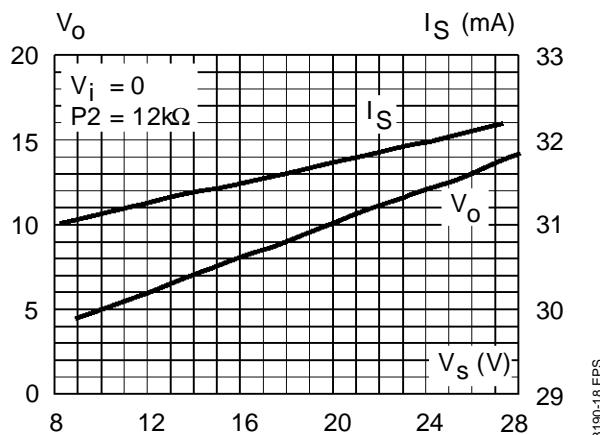

Figure 15 : Quiescent Drain and Quiescent Output Voltage versus Supply Voltage



APPLICATION INFORMATION
(refer to the block diagram)

IF Amplifier-limiter

It is made by six differential stages of 15dB gain each so that an open loop gain of 90dB is obtained. While a unity DC gain is provided, the AC closed loop gain is internally fixed at 70dB that allows a typical input sensitivity of 50μV.

The differential output signal is single ended by a 20dB gain amplifier that through a buffer stage, feeds the detector system.

Internal diodes protect the inputs against overloads.

- Pin 2 is the IF non-inverting input
- Pin 3 is decoupled by a capacitor to open the AC loop
- Pin 4 grounded by a capacitor, allows a typical

sensitivity of 50μV. (see VCR facility too).

Low-pass Filter, Fm Detector And Amplifier

The IF signal is detected by converting the frequency modulation into amplitude modulation and then detecting it.

Since the available modulated signal is a square wave, a 40 dB/decade low-pass filter cuts its harmonics so that a sine wave can feed the two-resonances external network L1, C8 and C9.

This network defines the working frequency value, the amplitude of the recovered audio signal and its distortion at the highest frequency deviations.

The two resonances f1 (series resonance) and f2 (parallel resonance) can be computed respectively by :

$$X_{C9} = \frac{X_{L1} \cdot X_{C8}}{X_{L1} + X_{C8}} \quad \text{and} \quad X_{L1} = X_{C8}$$

The ratio of these frequencies defines the peak-to-peak separation of the "S" curve :

$$\frac{f_2}{f_1} = \sqrt{1 + \frac{C_9}{C_8}}$$

A differential peak detector detects the audio frequency signal that amplified, reaches the deemphasis network R0 ; C11.

The AF amplifier can be muted (see turn-on and turn-off switch and VCR facility).

- Pin 7 is the output of the low-pass filter and one input of the differential peak detector
- Pin 8 is the other input of the differential peak detector
- Pin 9 is used to provide the required deemphasis time constant by grounding it with C11. At this pin, the internal impedance of which is typically of 1.1K, is available the recovered audio signal as auxiliary output.

DC Tone Control

The same signal available or applied to pin 10, after a voltage to current converter, reaches, the DC Tone Control block. It operates, inside the 10KHz bandwidth, by cutting the high audio frequencies with a variable slope of an RC network, by means of P₁.

The maximum slope of the RC network is of 20dB per decade and its pole is defined by :

X_{C11} = 6.8K, typically.

Pin 11 - At this pin is tied the tone capacitor.

Pin 12 - Is the DC Tone Control input.

DC Volume Control

After tone control regulation, the AF current signal reaches the DC volume control block that controls its intensity. The normal control, for which the block has been designed for a narrow spread, is produced by P₂ ; however, without P₂, a voltage control can be operated by forcing a voltage at pin 13 through R8.

- Pin 12, already seen as a DCTC input, is the reference voltage for the DCVC. Because of this, a small interface between tone and volume regulation can be expected.
- Pin 13 is the DC volume control input.
- Pin 14 after a current to voltage converter, the audio frequency signal comes out at this pin.

Audio Frequency Power Amplifier and Thermal Protection

Through C12 the signal reaches the amplifier non-inverting input. The closed loop gain is defined by

the feedback at pin 19 (inverting input) or by the ratio :

$$G_v = 20 \text{ Log } \frac{R_5 + R_4}{R_5} \text{ (dB)}$$

The amplifier, thermally protected, can supply 4W of power into a 16 load with 24V of supply voltage.

The power output stage is a class B type.

- Pin 20 is the non-inverting input
- Pin 19 is the inverting input
- Pin 17 is the output of the AFPA.

Turn-on And Turn-off Switch

This block has been mainly designed to avoid, turning on the TV set, that transients, produced by the vision output, can reach the speaker.

Moreover this block, together an optimized rise time and full time of the supply voltage V_s, can avoid any pop generally produced during the turn-on and the turn-off transients.

Turning on, pin 1 follows the supply voltage V_s by means of C7 ; a threshold is reached and the muting of the AFPA output (pin 17) is suddenly produced.

When V_s reaches it stop, C7 charges itself through the input impedance of pin 1 and the muting is removed with a time constant depending on the C7 value.

Turning off, the V_s trend, in series to the voltage V_s V₁ and which C7 is charged, drives pin 1 at a low level threshold and a sudden muting is produced again.

Since the turn-off can be operated with high output power, if the muting operates when the current through the inductance of the speaker is different from zero, a flyback is generated and then a small pop can be produced.

The flyback is clipped by integrated diodes.

The thresholds that produce the muting have been chosen in the way that 1 V_{pp} of ripple on the supply voltage does not produce any switching..

- Pin 1 is the turn-on and turn-off muting input.

Supply

An integrated voltage regulator with different output levels, supplies all the blocks operating with small signal.

- Pin 18 is the main supply of the device.
- Pin 5 ; pin 6 ; pin 15 and pin 16 are the ground of the supply. These pins are used to drain out from the device the heat produced by the dissipated power.

Components	Units	Appl. 4.5 MHz	Appl. 5.5 MHz	Appl. 6 MHz
L1	μH	10 $Q_o = 60$	12 $Q_o = 80$	10 $Q_o = 70$
C5	pF	120	68	68
C4	pF	9	8.2	6.8
C8	nF	68	47	47
C. F		Murata SFE 4.5 MA	Murata SFE 5.5 MB	Murata SFE 6.0 MB
C1	pF	22	18	18
R2	Ω	1000	560	470
R3	Ω	1000	560	470

8190-05.TBL

Figure 16 : Application Circuit

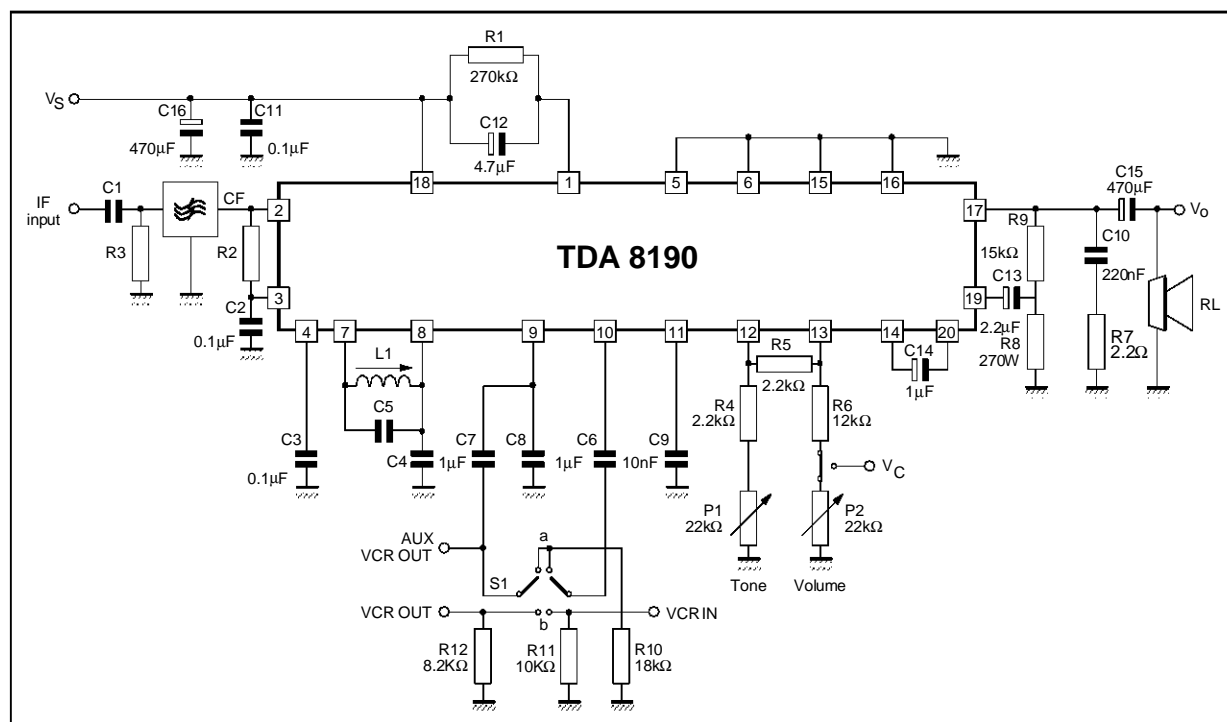

8190-19.EPS

TDA8190

Figure 17 : PC Board and Components Layout of the Circuit of Figure 16 (1 : 1 scale)

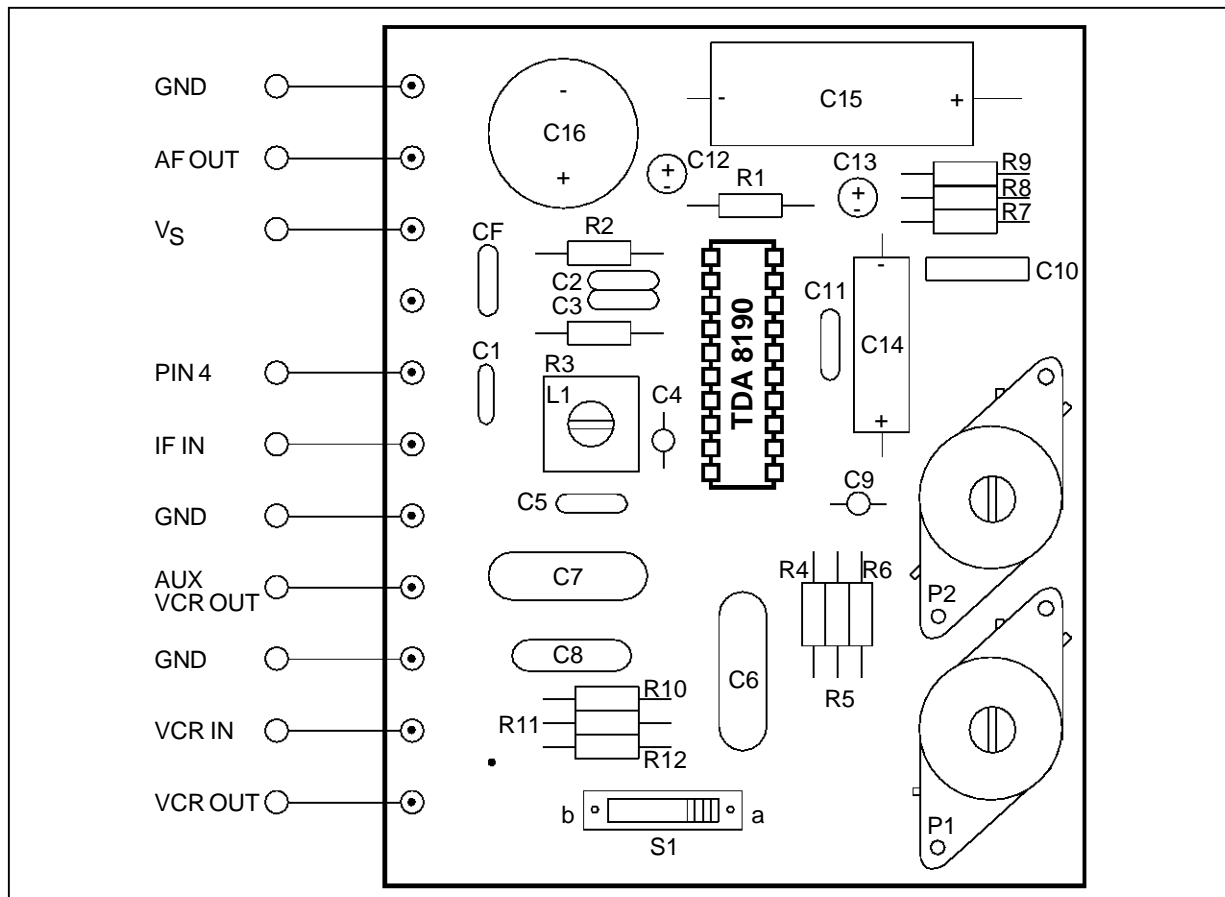

PACKAGE MECHANICAL DATA
20 PINS - PLASTIC DIP

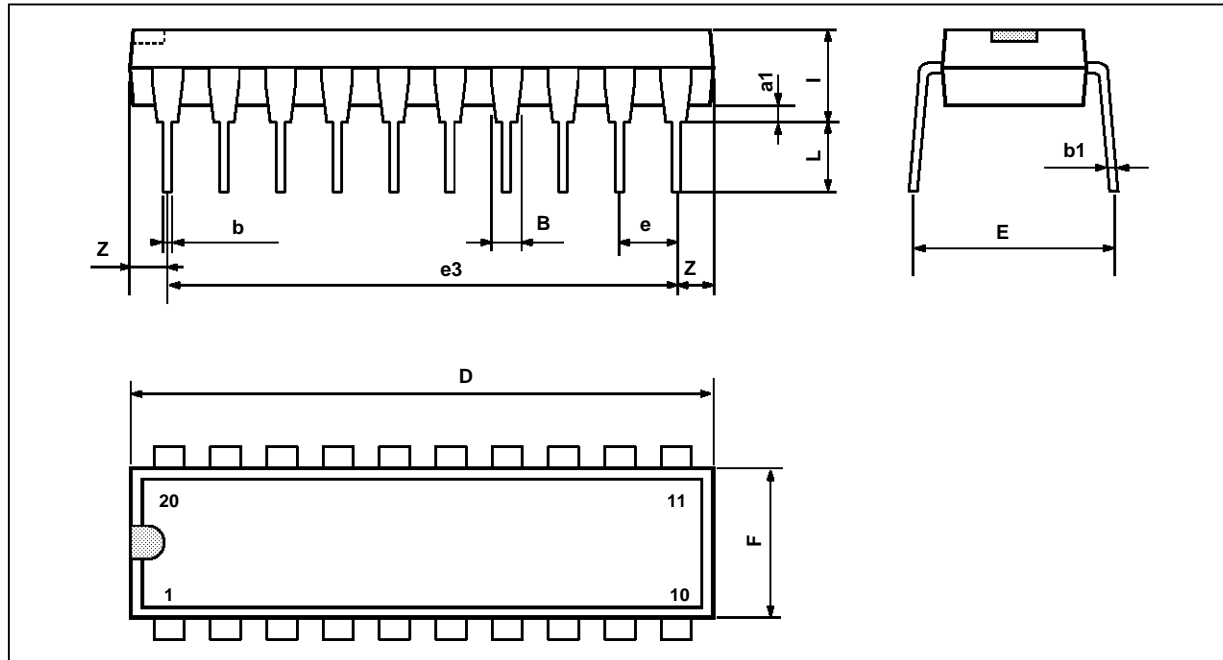

PM-DIP20.EPS

Dimensions	Millimeters			Inches		
	Min.	Typ.	Max.	Min.	Typ.	Max.
a1	0.254			0.010		
B	1.39		1.65	0.055		0.065
b		0.45			0.018	
b1		0.25			0.010	
D			25.4			1.000
E		8.5			0.335	
e		2.54			0.100	
e3		22.86			0.900	
F			7.1			0.280
i			3.93			0.155
L		3.3			0.130	
Z			1.34			0.053

DIP20.TBL

Information furnished is believed to be accurate and reliable. However, SGS-THOMSON Microelectronics assumes no responsibility for the consequences of use of such information nor for any infringement of patents or other rights of third parties which may result from its use. No licence is granted by implication or otherwise under any patent or patent rights of SGS-THOMSON Microelectronics. Specifications mentioned in this publication are subject to change without notice. This publication supersedes and replaces all information previously supplied. SGS-THOMSON Microelectronics products are not authorized for use as critical components in life support devices or systems without express written approval of SGS-THOMSON Microelectronics.

© 1994 SGS-THOMSON Microelectronics - All Rights Reserved

Purchase of I²C Components of SGS-THOMSON Microelectronics, conveys a license under the Philips I²C Patent. Rights to use these components in a I²C system, is granted provided that the system conforms to the I²C Standard Specifications as defined by Philips.

SGS-THOMSON Microelectronics GROUP OF COMPANIES

Australia - Brazil - China - France - Germany - Hong Kong - Italy - Japan - Korea - Malaysia - Malta - Morocco
The Netherlands - Singapore - Spain - Sweden - Switzerland - Taiwan - Thailand - United Kingdom - U.S.A.