



TDA7566

MULTIFUNCTION QUAD POWER AMPLIFIER WITH BUILT-IN DIAGNOSTICS FEATURES

- DMOS POWER OUTPUT
- HIGH OUTPUT POWER CAPABILITY 4x25W/4Ω @ 14.4V, 1KHZ, 10% THD, 4x35W EIAJ
- MAX. OUTPUT POWER 4x60W/2W
- FULL I2C BUS DRIVING:- ST-BY-INDEPENDENT FRONT/REAR SOFT PLAY/MUTE- SELECTABLE GAIN 26dB - 12dB- I2C BUS DIGITAL DIAGNOSTICS
- FULL FAULT PROTECTION
- DC OFFSET DETECTION
- FOUR INDEPENDENT SHORT CIRCUIT PROTECTION
- CLIPPING DETECTOR (1%/10%)
- ESD PROTECTION

MULTIPOWER BCD TECHNOLOGY

MOSFET OUTPUT POWER STAGE

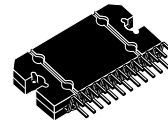

FLEXIWATT25

ORDERING NUMBER: TDA7566

DESCRIPTION

The TDA7566 is a new BCD technology QUAD BRIDGE type of car radio amplifier in Flexiwatt25 package specially intended for car radio applications. Thanks to the DMOS output stage the TDA7566 has

a very low distortion allowing a clear powerful sound.

This device is equipped with a full diagnostics array that communicates the status of each speaker through the I²C bus.

The possibility to control the configuration and behaviour of the device by means of the I²C bus makes TDA7566 a very flexible machine.

BLOCK DIAGRAM

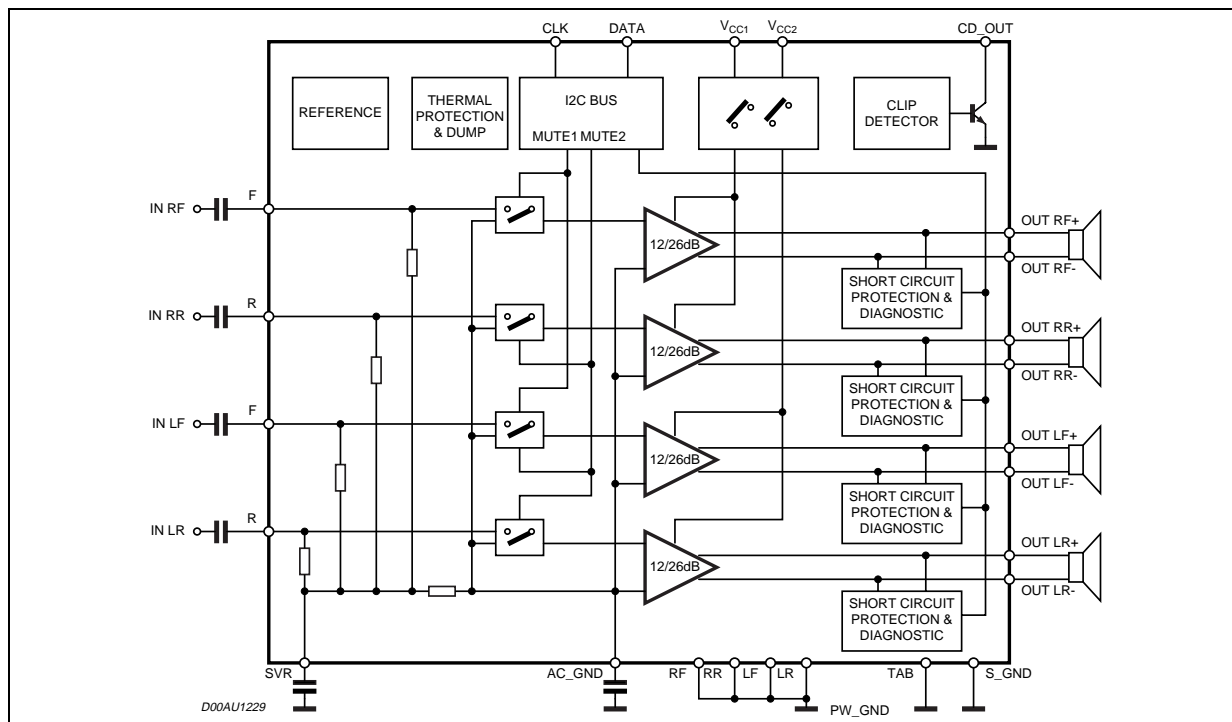

TDA7566

ABSOLUTE MAXIMUM RATINGS

Symbol	Parameter	Value	Unit
V_{op}	Operating Supply Voltage	18	V
V_S	DC Supply Voltage	28	V
V_{peak}	Peak Supply Voltage (for $t = 50ms$)	50	V
V_{CK}	CK pin Voltage	6	V
V_{DATA}	Data Pin Voltage	6	V
I_O	Output Peak Current (not repetitive $t = 100\mu s$)	8	A
I_O	Output Peak Current (repetitive $f > 10Hz$)	6	A
P_{tot}	Power Dissipation $T_{case} = 70^\circ C$	85	W
T_{stg}, T_j	Storage and Junction Temperature	-55 to 150	$^\circ C$

THERMAL DATA

Symbol	Description	Value	Unit
$R_{th\ j-case}$	Thermal Resistance Junction-case	Max. 1	$^\circ C/W$

PIN CONNECTION (top view)

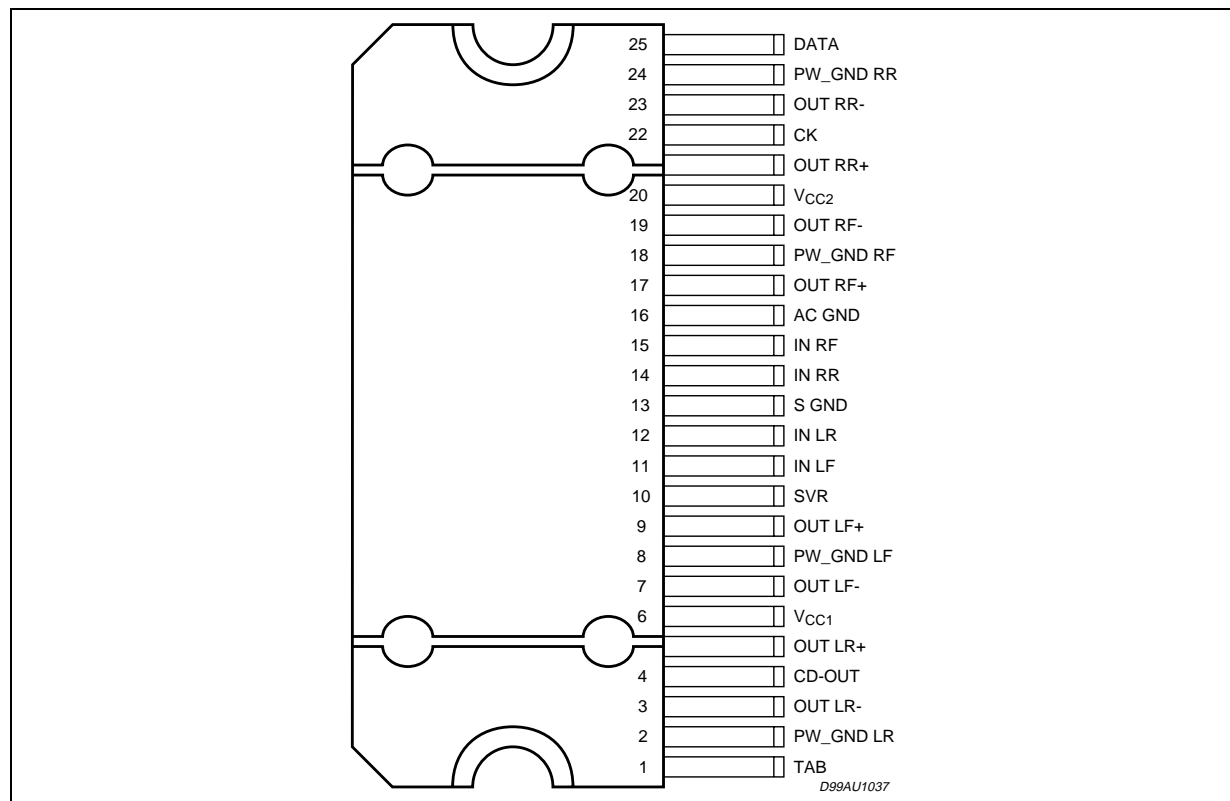
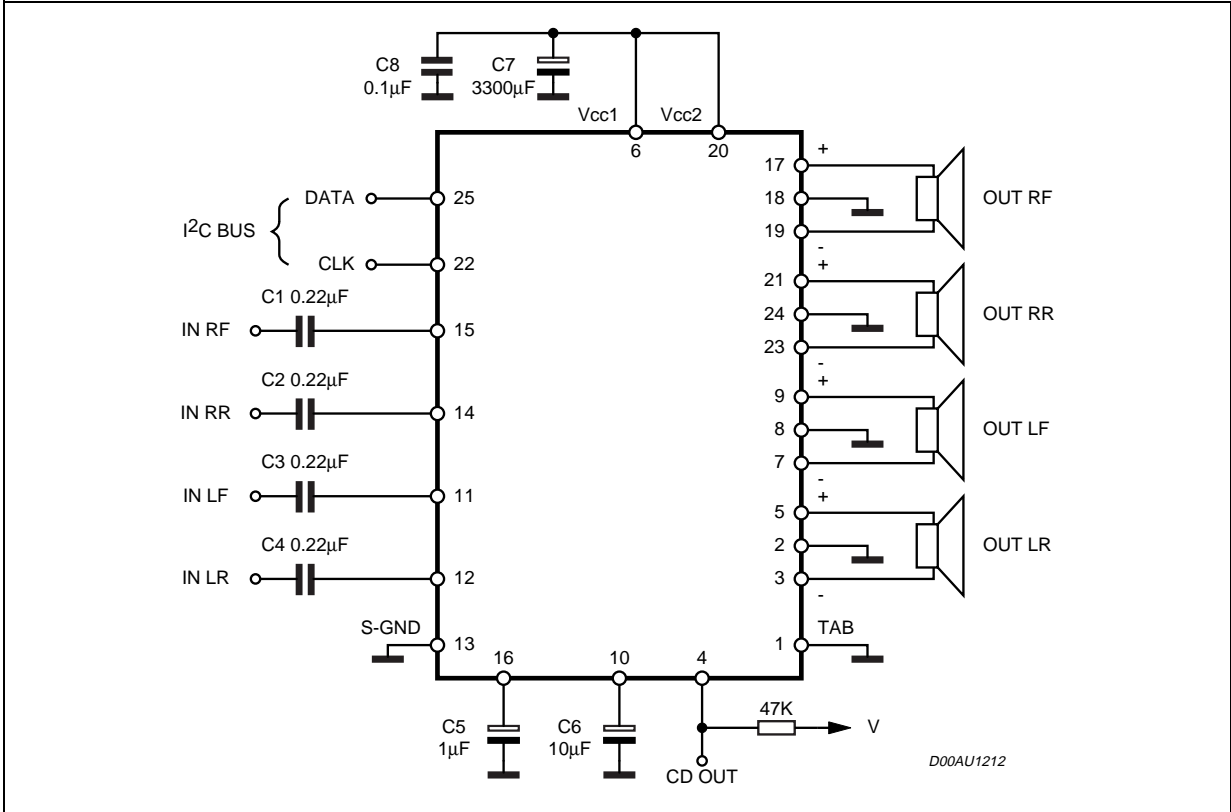

Figure 1. Test and Application Circuit



ELECTRICAL CHARACTERISTICS

(Refer to the test circuit, $V_S = 14.4V$; $R_L = 4\Omega$; $f = 1KHz$; $G_V = 26dB$; $T_{amb} = 25^\circ C$; unless otherwise specified.)

Symbol	Parameter	Test Condition	Min.	Typ.	Max.	Unit
POWER AMPLIFIER						
V_S	Supply Voltage Range		8		18	V
I_d	Total Quiescent Drain Current			150	300	mA
P_O	Output Power	EIAJ ($V_S = 13.7V$)	32	35		W
		THD = 10%	22	25		W
		THD = 1%	16	20		W
		$R_L = 2\Omega$; EIAJ ($V_S = 13.7V$)	50	55		W
		$R_L = 2\Omega$; THD 10%	32	38		W
		$R_L = 2\Omega$; THD 1%	25	30		W
		$R_L = 2\Omega$; MAX POWER	55	60		W
THD	Total Harmonic Distortion	$P_O = 1W$ to $10W$;		0.04	0.1	%
		$G_V = 12dB$; $V_O = 0.1$ to $5V_{RMS}$		0.02	0.05	%
C_T	Cross Talk	$f = 1KHz$ to $10KHz$, $R_G = 600W$	50	60		dB
R_{IN}	Input Impedance		60	100	130	K Ω
G_{V1}	Voltage Gain 1		25	26	27	dB
ΔG_{V1}	Voltage Gain Match 1		-1	0	1	dB
G_{V2}	Voltage Gain 2			12		dB
E_{IN1}	Output Noise Voltage 1	$R_g = 600\Omega$; $20Hz$ to $22kHz$		35	100	μV
E_{IN2}	Output Noise Voltage 2	$R_g = 600\Omega$; $G_V = 12dB$; $20Hz$ to $22kHz$		12		μV
SVR	Supply Voltage Rejection	$f = 100Hz$ to $10kHz$; $V_r = 1V_{pk}$; $R_g = 600\Omega$	50	60		dB
BW	Power Bandwidth		100			KHz
A_{SB}	Stand-by Attenuation		90	110		dB
I_{SB}	Stand-by Current			25	100	μA
A_M	Mute Attenuation		80	100		dB
V_{OS}	Offset Voltage	Mute & Play	-100	0	100	mV
V_{AM}	Min. Supply Voltage Threshold		7	7.5	8	V
T_{ON}	Turn on Delay	D2/D1 (IB1) 0 to 1		20	50	ms
T_{OFF}	Turn off Delay	D2/D1 (IB1) 1 to 0		20	50	ms
CD_{LK}	Clip Det High Leakage Current	CD off		0	15	μA
CD_{SAT}	Clip Det Sat. Voltage	CD on; $I_{CD} = 1mA$			300	mV
CD_{THD}	Clip Det THD level	D0 (IB1) = 0	0	1	2	%
		D0 (IB1) = 1	5	10	15	%
TURN ON DIAGNOSTICS 1 (Power Amplifier Mode)						
Pgnd	Short to GND det. (below this limit, the Output is considered in Short Circuit to GND)	Power Amplifier in st-by			1.2	V
Pvs	Short to Vs det. (above this limit, the Output is considered in Short Circuit to VS)		$V_S - 1.2$			V
Pnop	Normal operation thresholds. (Within these limits, the Output is considered without faults).		1.8		$V_S - 1.8$	V
Lsc	Shorted Load det.				0.5	Ω
Lop	Open Load det.		85			Ω
Lnop	Normal Load det.		1.65		45	Ω

ELECTRICAL CHARACTERISTICS (continued)(Refer to the test circuit, $V_S = 14.4V$; $R_L = 4\Omega$; $f = 1KHz$; $G_V = 26dB$; $T_{amb} = 25^\circ C$; unless otherwise specified.)

Symbol	Parameter	Test Condition	Min.	Typ.	Max.	Unit
TURN ON DIAGNOSTICS 2 (Line Driver Mode)						
Pgnd	Short to GND det. (below this limit, the Output is considered in Short Circuit to GND)	Power Amplifier in st-by			1.2	V
Pvs	Short to Vs det. (above this limit, the Output is considered in Short Circuit to VS)		Vs -1.2			V
Pnop	Normal operation thresholds. (Within these limits, the Output is considered without faults).		1.8		Vs -1.8	V
Lsc	Shorted Load det.			2	Ω	
Lop	Open Load det.		330		Ω	
Lnop	Normal Load det.		7		180	Ω
PERMANENT DIAGNOSTICS 2 (Power Amplifier Mode or Line Driver Mode)						
Pgnd	Short to GND det. (below this limit, the Output is considered in Short Circuit to GND)	Power Amplifier in Mute or Play, one or more short circuits protection activated			1.2	V
Pvs	Short to Vs det. (above this limit, the Output is considered in Short Circuit to VS)		Vs -1.2			V
Pnop	Normal operation thresholds. (Within these limits, the Output is considered without faults).		1.8		Vs -1.8	V
L _{SC}	Shorter Load det.	Power Amplifier mode			0.5	Ω
		Line Driver mode			2	Ω
V _O	Offset Detection	Power Amplifier in play, AC Input signals = 0	1.5	2	2.5	V
I _{NL}	Normal load current detection	$V_O < (V_S - 5)\mu k$			500	mA
I _{OL}	Open load current detection		250			mA
I²C BUS INTERFACE						
f _{SCL}	Clock Frequency			400		KHz
V _{IL}	Input Low Voltage				1.5	V
V _{IH}	Input High Voltage		2.3			V

Figure 2. Quiescent Current vs. Supply Voltage

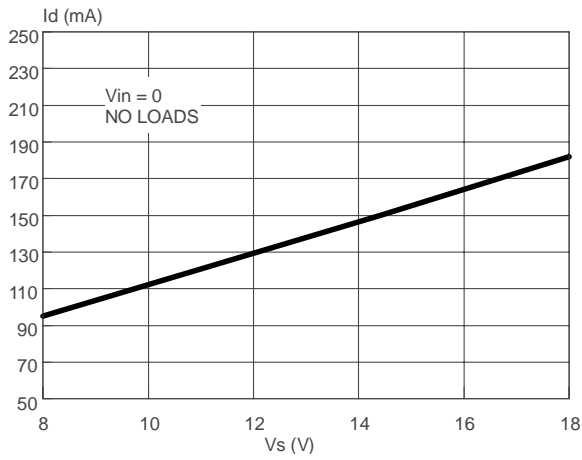

Figure 5. Distortion vs. Output Power (4Ω)

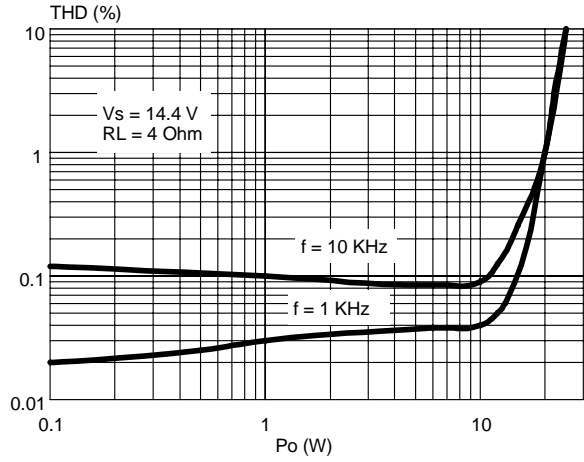

Figure 3. Output Power vs. Supply Voltage (4Ω)

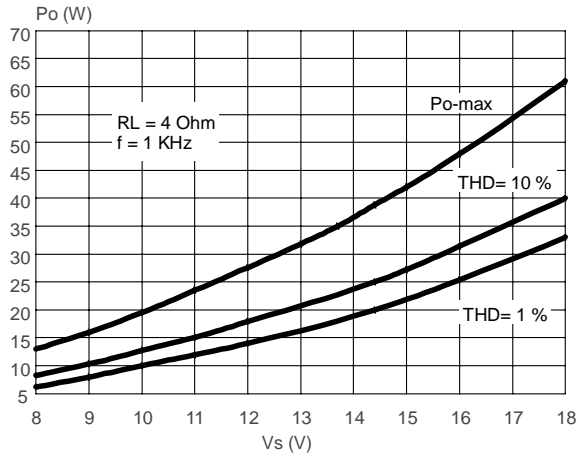

Figure 6. Distortion vs. Output Power (2Ω)

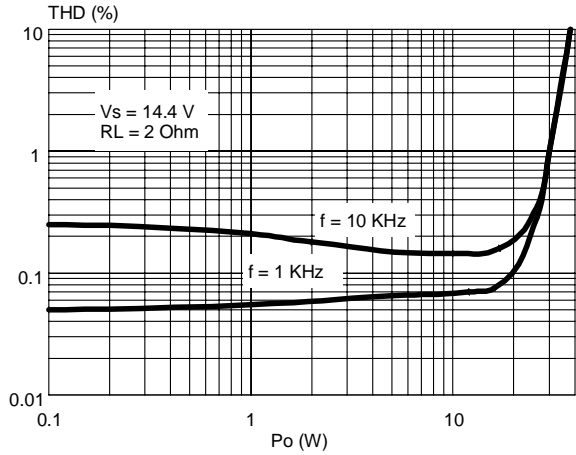

Figure 4. Output Power vs. Supply Voltage (2Ω)

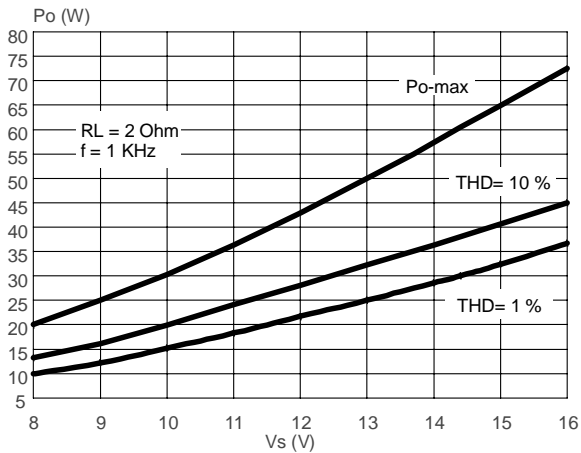

Figure 7. Distortion vs. Frequency (4Ω)

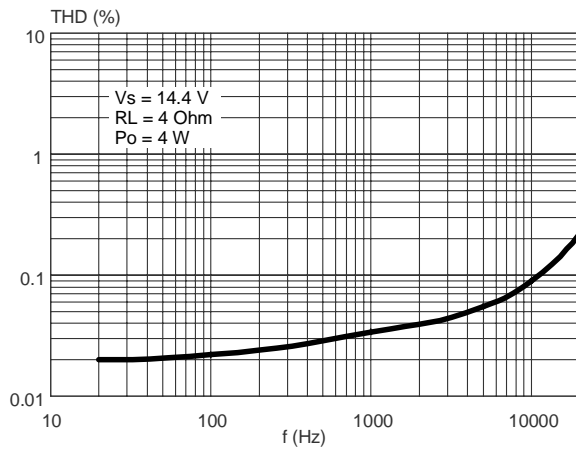

Figure 8. Distortion vs. Frequency (2W)

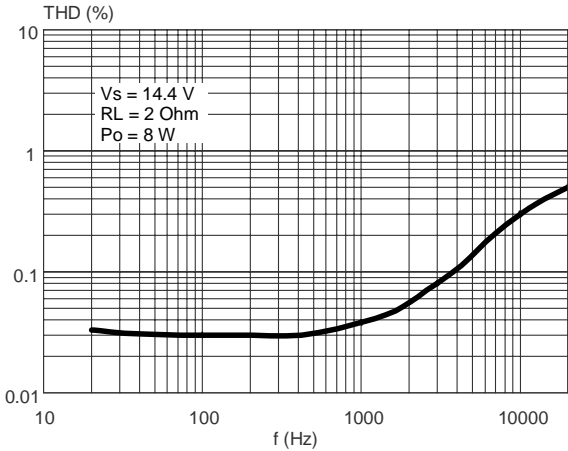

Figure 9. Crosstalk vs. Frequency

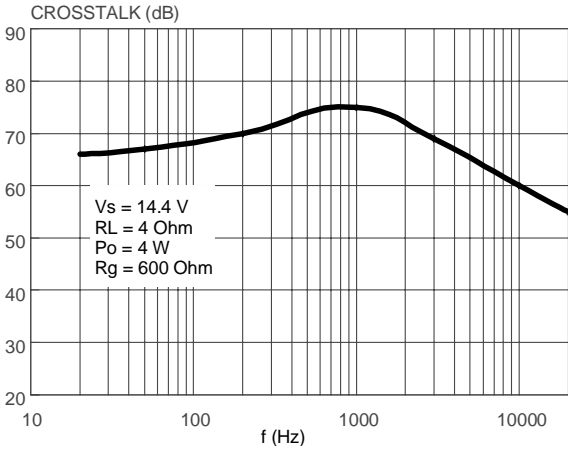

Figure 10. Supply Voltage Rejection vs. Freq.

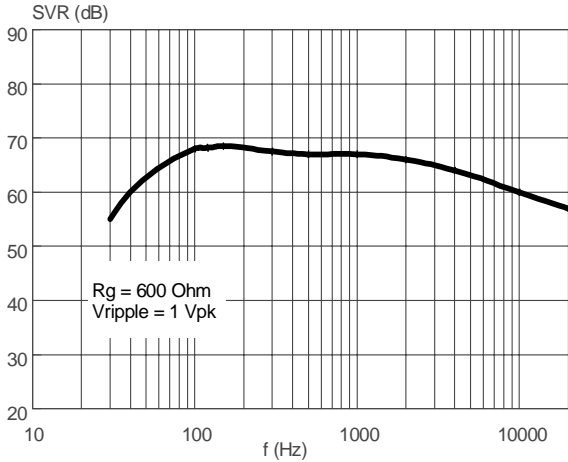

Figure 11. Power Dissipation & Efficiency vs. Output Power (4Ω, SINE)

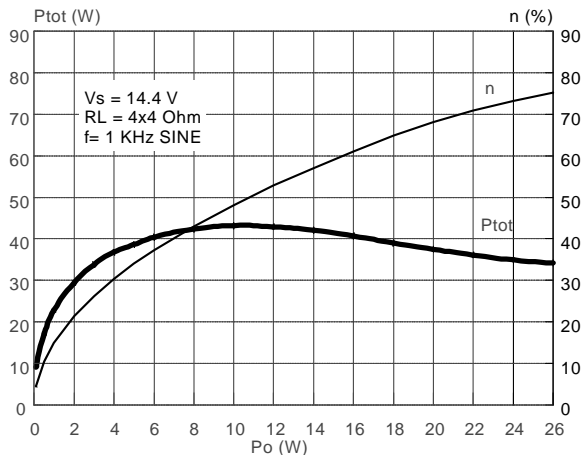

Figure 12. Power Dissipation vs. Average Output Power (Audio Program Simulation, 4Ω)

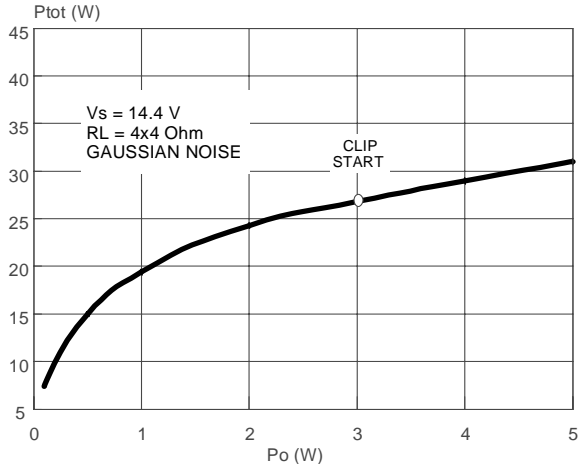
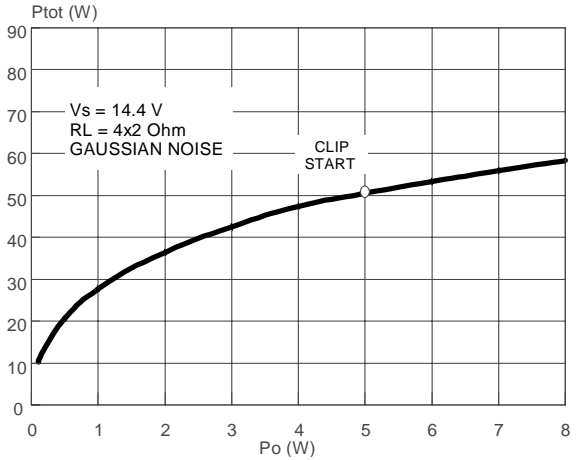

Figure 13. Power Dissipation vs. Average Output Power (Audio Program Simulation, 2Ω)



DIAGNOSTICS FUNCTIONAL DESCRIPTION:

a) TURN-ON DIAGNOSTIC.

It is activated at the turn-on (stand-by out) under I2Cbus request. Detectable output faults are:

- SHORT TO GND
- SHORT TO Vs
- SHORT ACROSS THE SPEAKER
- OPEN SPEAKER

To verify if any of the above misconnections are in place, a subsonic (inaudible) current pulse (fig. 14) is internally generated, sent through the speaker(s) and sunk back. The Turn On diagnostic status is internally stored until a successive diagnostic pulse is requested (after a I²C reading).

If the "stand-by out" and "diag. enable" commands are both given through a single programming step, the pulse takes place first (power stage still in stand-by mode, low, outputs = high impedance).

Afterwards, when the Amplifier is biased, the PERMANENT diagnostic takes place. The previous Turn On state is kept until a short appears at the outputs.

Figure 14. Turn - On diagnostic: working principle

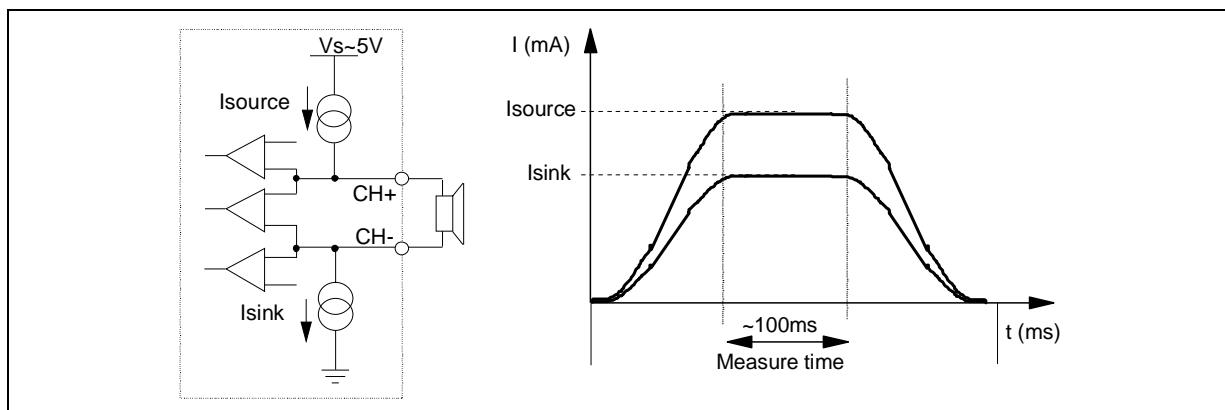

Fig. 15 and 16 show SVR and OUTPUT waveforms at the turn-on (stand-by out) with and without TURN-ON DIAGNOSTIC.

Figure 15. SVR and Output behaviour (CASE 1: without turn-on diagnostic)

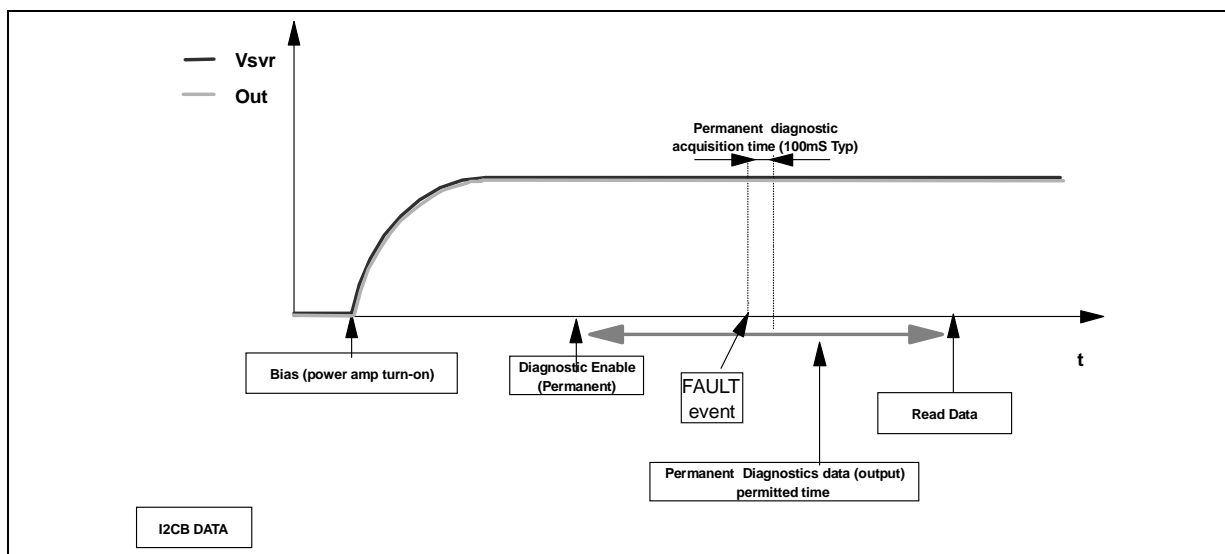
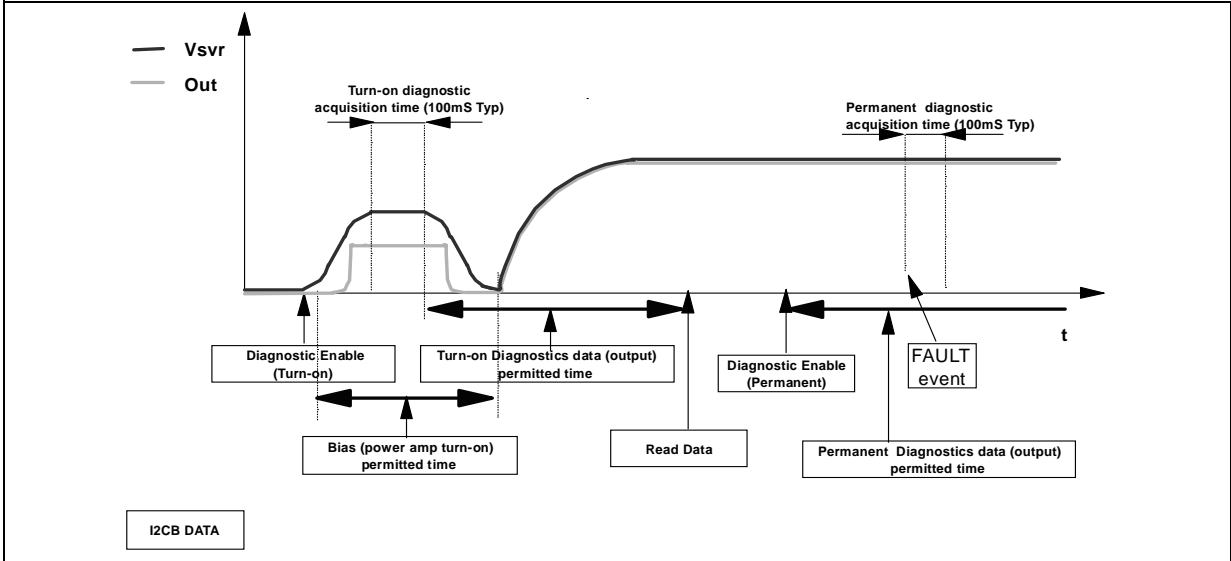
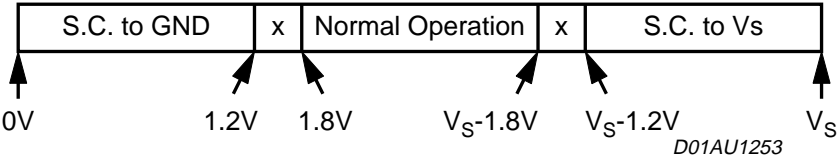

Figure 16. SVR and Output pin behaviour (CASE 2: with turn-on diagnostic)



The information related to the outputs status is read and memorized at the end of the current pulse top. The acquisition time is 100 ms (typ.). No audible noise is generated in the process. As for SHORT TO GND / V_s the fault-detection thresholds remain unchanged from 26 dB to 12 dB gain setting. They are as follows:



Concerning SHORT ACROSS THE SPEAKER / OPEN SPEAKER, the threshold varies from 26 dB to 12 dB gain setting, since different loads are expected (either normal speaker's impedance or high impedance). The values in case of 26 dB gain are as follows:

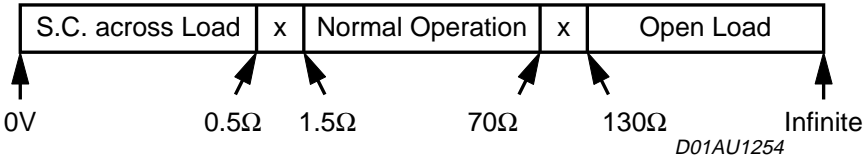

If the Line-Driver mode ($G_v = 12$ dB and Line Driver Mode diagnostic = 1) is selected, the same thresholds will change as follows:

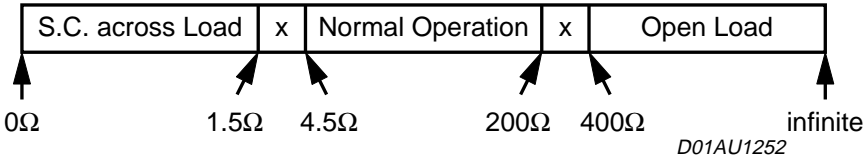

b) PERMANENT DIAGNOSTICS.

Detectable conventional faults are:

- SHORT TO GND
- SHORT TO Vs
- SHORT ACROSS THE SPEAKER

The following additional features are provided:

- OUTPUT OFFSET DETECTION
- AC DIAGNOSTIC

The TDA7566 has 2 operating statuses:

- 1 RESTART mode. The diagnostic is not enabled. Each audio channel operates independently from each other. If any of the a.m. faults occurs, only the channel(s) interested is shut down. A check of the output status is made every 1 ms (fig. 17). Restart takes place when the overload is removed.
- 2 DIAGNOSTIC mode. It is enabled via I2C bus and self activates if an output overload (such to cause the intervention of the short-circuit protection) occurs to the speakers outputs . Once activated, the diagnostics procedure develops as follows (fig. 18):
 - To avoid momentary re-circulation spikes from giving erroneous diagnostics, a check of the output status is made after 1ms: if normal situation (no overloads) is detected, the diagnostic is not performed and the channel returns back active.
 - Instead, if an overload is detected during the check after 1 ms, then a diagnostic cycle having a duration of about 100 ms is started.
 - After a diagnostic cycle, the audio channel interested by the fault is switched to RESTART mode. The relevant data are stored inside the device and can be read by the microprocessor. When one cycle has terminated, the next one is activated by an I2C reading. This is to ensure continuous diagnostics throughout the car-radio operating time.
 - To check the status of the device a sampling system is needed. The timing is chosen at microprocessor level (over half a second is recommended).

Figure 17. Restart timing without Diagnostic Enable (Permanent)
Each 1ms time, a sampling of the fault is done

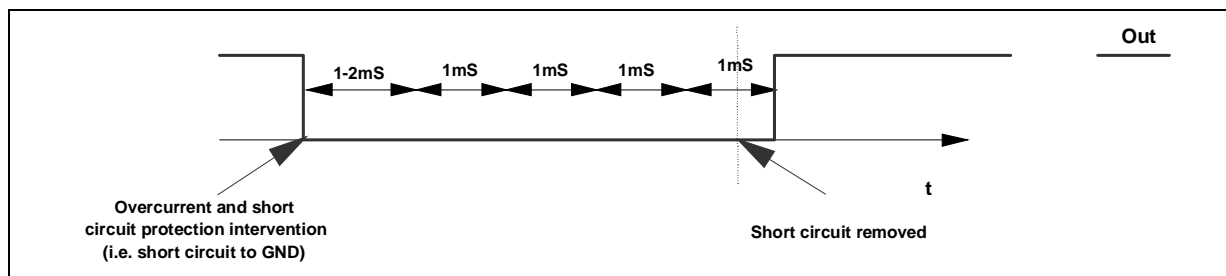
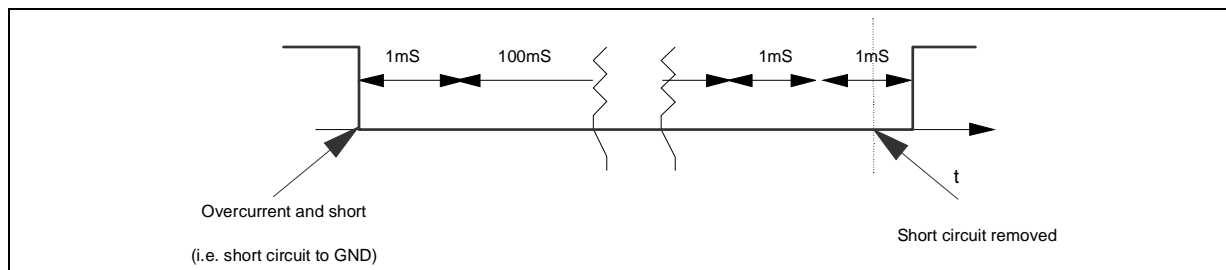

Figure 18. Restart timing with Diagnostic Enable (Permanent)



OUTPUT DC OFFSET DETECTION.

Any DC output offset exceeding $\pm 2V$ are signalled out. This inconvenient might occur as a consequence of initially defective or aged and worn-out input capacitors feeding a DC component to the inputs, so putting the speakers at risk of overheating.

This diagnostic has to be performed with low-level output AC signal (or $V_{in} = 0$).

The test is run with selectable time duration by microprocessor (from a "start" to a "stop" command):

START = Last reading operation or setting IB1 - D5 - (OFFSET enable) to 1

STOP = Actual reading operation

Excess offset is signalled out if persistent throughout the assigned testing time. This feature is disabled if any overloads leading to activation of the short-circuit protection occurs in the process.

AC DIAGNOSTIC.

It is targeted at detecting accidental disconnection of tweeters in 2-way speaker and, more in general, presence of capacitively (AC) coupled loads.

This diagnostic is based on the notion that the overall speaker's impedance (woofer + parallel tweeter) will tend to increase towards high frequencies if the tweeter gets disconnected, because the remaining speaker (woofer) would be out of its operating range (high impedance). The diagnostic decision is made according to peak output current thresholds, as follows:

$I_{out} > 500\text{mA}_{pk} = \text{NORMAL STATUS}$

$I_{out} < 250\text{mA}_{pk} = \text{OPEN TWEETER}$

To correctly implement this feature, it is necessary to briefly provide a signal tone (with the amplifier in "play") whose frequency and magnitude are such to determine an output current higher than 500mA_{pk} in normal conditions and lower than 250mA_{pk} should the parallel tweeter be missing. The test has to last for a minimum number of 3 sine cycles starting from the activation of the AC diagnostic function IB2<D2> up to the I²C reading of the results (measuring period). To confirm presence of tweeter, it is necessary to find at least 3 current pulses over 500mA over all the measuring period, else an "open tweeter" message will be issued.

The frequency / magnitude setting of the test tone depends on the impedance characteristics of each specific speaker being used, with or without the tweeter connected (to be calculated case by case). High-frequency tones ($> 10 \text{ KHz}$) or even ultrasonic signals are recommended for their negligible acoustic impact and also to maximize the impedance module's ratio between with tweeter-on and tweeter-off.

Fig. 19 shows the Load Impedance as a function of the peak output voltage and the relevant diagnostic fields.

This feature is disabled if any overloads leading to activation of the short-circuit protection occurs in the process.

Figure 19. Current detection: Load impedance magnitude $|Z|$ Vs. output peak voltage of the sinus

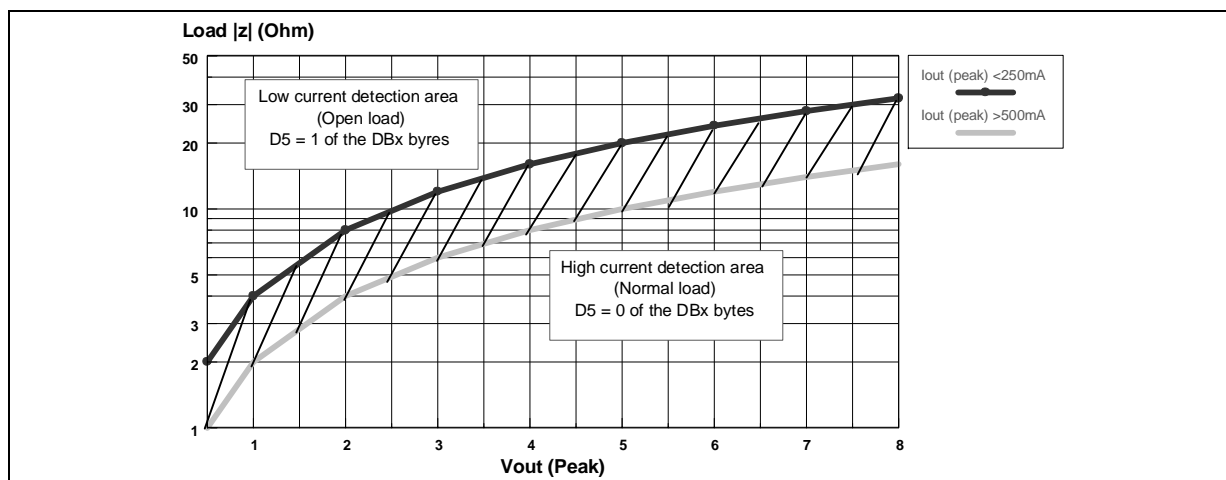

MULTIPLE FAULTS.

When more misconnections are simultaneously in place at the audio outputs, it is guaranteed that at least one of them is initially read out. The others are notified after successive cycles of I²C reading and faults removal, provided that the diagnostic is enabled. This is true for both kinds of diagnostic (Turn on and Permanent).

The table below shows all the couples of double-fault possible. It should be taken into account that a short circuit with the 4 ohm speaker unconnected is considered as double fault.

Double fault table for Turn On Diagnostic					
	S. GND (so)	S. GND (sk)	S. Vs	S. Across L.	Open L.
S. GND (so)	S. GND	S. GND	S. Vs + S. GND	S. GND	S. GND
S. GND (sk)	/	S. GND	S. Vs	S. GND	Open L. (*)
S. Vs	/	/	S. Vs	S. Vs	S. Vs
S. Across L.	/	/	/	S. Across L.	N.A.
Open L.	/	/	/	/	Open L. (*)

S. GND (so) / S. GND (sk) in the above table make a distinction according to which of the 2 outputs is shorted to ground (test-current source side= so, test-current sink side = sk). More precisely, in channels LF and LR, so = CH+, sk = CH-; in channels LR and RF, so = CH-, SK = CH+.

In Permanent Diagnostic the table is the same, with only a difference concerning Open Load (*), which is not among the recognisable faults. Should an Open Load be present during the device's normal working, it would be detected at a subsequent Turn on Diagnostic cycle (i.e. at the successive Car Radio Turn on).

FAULTS AVAILABILITY

All the results coming from I2Cbus, by read operations, are the consequence of measurements inside a defined period of time. If the fault is stable throughout the whole period, it will be sent out. This is true for DC diagnostic (Turn on and Permanent), for Offset Detector, for AC Diagnostic (the low current sensor needs to be stable to confirm the Open tweeter).

To guarantee always resident functions, every kind of diagnostic cycles (Turn on, Permanent, Offset, AC) will be reactivate after any I2C reading operation. So, when the micro reads the I²C, a new cycle will be able to start, but the read data will come from the previous diag. cycle (i.e. The device is in Turn On state, with a short to Gnd, then the short is removed and micro reads I²C. The short to Gnd is still present in bytes, because it is the result of the previous cycle. If another I²C reading operation occurs, the bytes do not show the short). In general to observe a change in Diagnostic bytes, two I²C reading operations are necessary.

I²C PROGRAMMING/READING SEQUENCE

A correct turn on/off sequence respectful of the diagnostic timings and producing no audible noises could be as follows (after battery connection):

TURN-ON: (STAND-BY OUT + DIAG ENABLE) --- 500 ms (min) --- MUTING OUT

TURN-OFF: MUTING IN --- 20 ms --- (DIAG DISABLE + STAND-BY IN)

Car Radio Installation: DIAG ENABLE (write) --- 200 ms --- I2C read (repeat until All faults disappear).

AC TEST: FEED H.F. TONE -- AC DIAG ENABLE (write) --- WAIT > 3 CYCLES --- I2C read
(repeat I2C reading until tweeter-off message disappears).

OFFSET TEST: Device in Play (no signal) -- OFFSET ENABLE - 30ms - I2C reading
(repeat I2C reading until high-offset message disappears).

I²C BUS INTERFACE

Data transmission from microprocessor to the TDA7566 and viceversa takes place through the 2 wires I²C BUS interface, consisting of the two lines SDA and SCL (pull-up resistors to positive supply voltage must be connected).

Data Validity

As shown by fig. 20, the data on the SDA line must be stable during the high period of the clock. The HIGH and LOW state of the data line can only change when the clock signal on the SCL line is LOW.

Start and Stop Conditions

As shown by fig. 21 a start condition is a HIGH to LOW transition of the SDA line while SCL is HIGH. The stop condition is a LOW to HIGH transition of the SDA line while SCL is HIGH.

Byte Format

Every byte transferred to the SDA line must contain 8 bits. Each byte must be followed by an acknowledge bit. The MSB is transferred first.

Acknowledge

The transmitter* puts a resistive HIGH level on the SDA line during the acknowledge clock pulse (see fig. 22). The receiver** the acknowledges has to pull-down (LOW) the SDA line during the acknowledge clock pulse, so that the SDA line is stable LOW during this clock pulse.

* Transmitter

- master (µP) when it writes an address to the TDA7566
- slave (TDA7566) when the µP reads a data byte from TDA7566

** Receiver

- slave (TDA7566) when the µP writes an address to the TDA7566
- master (µP) when it reads a data byte from TDA7566

Figure 20. Data Validity on the I²C BUS

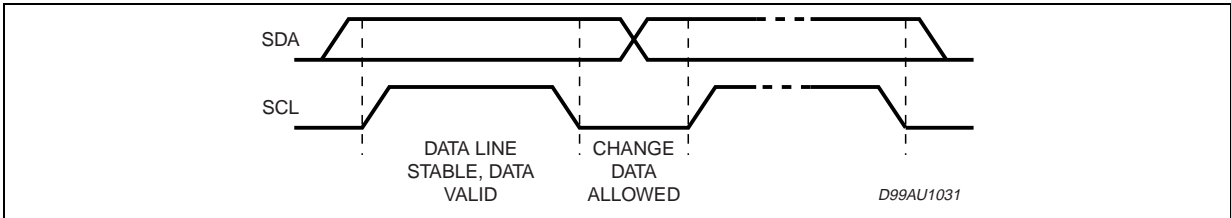

Figure 21.

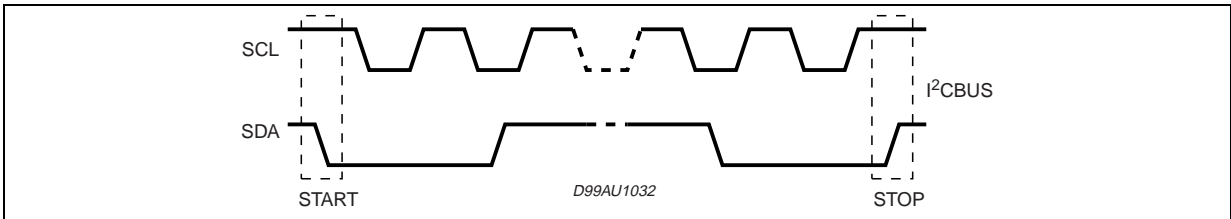
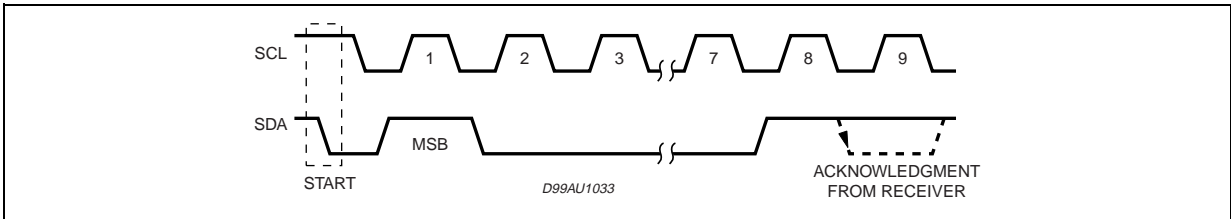

Figure 22.



TDA7566

SOFTWARE SPECIFICATIONS

All the functions of the TDA7566 are activated by I²C interface.

The bit 0 of the "ADDRESS BYTE" defines if the next bytes are write instruction (from μ P to TDA7566) or read instruction (from TDA7566 to μ P).

Chip Address:

D7	1	1	0	1	1	0	0	D0	X	D8 Hex
-----------	---	---	---	---	---	---	---	-----------	---	--------

X = 0 Write to device

X = 1 Read from device

If R/W = 0, the μ P sends 2 "Instruction Bytes": IB1 and IB2.

IB1

D7	X
D6	Diagnostic enable (D6 = 1) Diagnostic defeat (D6 = 0)
D5	Offset Detection enable (D5 = 1) Offset Detection defeat (D5 = 0)
D4	Front Channel Gain = 26dB (D4 = 0) Gain = 12dB (D4 = 1)
D3	Rear Channel Gain = 26dB (D3 = 0) Gain = 12dB (D3 = 1)
D2	Mute front channels (D2 = 0) Unmute front channels (D2 = 1)
D1	Mute rear channels (D1 = 0) Unmute rear channels (D1 = 1)
D0	CD 2% (D0 = 0) CD 10% (D0 = 1)

IB2

D7	X
D6	used for testing
D5	used for testing
D4	Stand-by on - Amplifier not working - (D4 = 0) Stand-by off - Amplifier working - (D4 = 1)
D3	Power amplifier mode diagnostic (D3 = 0) Line driver mode diagnostic (D3 = 1)
D2	Current detection diagnostic enabled (D2 = 1) Current detection diagnostic defeat (D2 = 0)
D1	X
D0	X

If R/W = 1, the TDA7566 sends 4 "Diagnostics Bytes" to mP: DB1, DB2, DB3 and DB4.

DB1

D7	Thermal warning active (D7 = 1)
D6	Diag. cycle not activated or not terminated (D6 = 0) Diag. cycle terminated (D6 = 1)
D5	Channel LF current detection Output peak current < 250mA - Open load (D5 = 1) Output peak current > 500mA - Open load (D5 = 0)
D4	Channel LF Turn-on diagnostic (D4 = 0) Permanent diagnostic (D4 = 1)
D3	Channel LF Normal load (D3 = 0) Short load (D3 = 1)
D2	Channel LF Turn-on diag.: No open load (D2 = 0) Open load detection (D2 = 1) Offset diag.: No output offset (D2 = 0) Output offset detection (D2 = 1)
D1	Channel LF No short to Vcc (D1 = 0) Short to Vcc (D1 = 1)
D0	Channel LF No short to GND (D1 = 0) Short to GND (D1 = 1)

DB2

D7	Offset detection not activated (D7 = 0) Offset detection activated (D7 = 1)
D6	Current sensor not activated (D6 = 0) Current sensor activated (D6 = 1)
D5	Channel LR current detection Output peak current < 250mA - Open load (D5 = 1) Output peak current > 500mA - Open load (D5 = 0)
D4	Channel LR Turn-on diagnostic (D4 = 0) Permanent diagnostic (D4 = 1)
D3	Channel LR Normal load (D3 = 0) Short load (D3 = 1)
D2	Channel LR Turn-on diag.: No open load (D2 = 0) Open load detection (D2 = 1) Permanent diag.: No output offset (D2 = 0) Output offset detection (D2 = 1)
D1	Channel LR No short to Vcc (D1 = 0) Short to Vcc (D1 = 1)
D0	Channel LR No short to GND (D1 = 0) Short to GND (D1 = 1)

DB3

D7	Stand-by status (= IB1 - D4)
D6	Diagnostic status (= IB1 - D6)
D5	Channel RF current detection Output peak current < 250mA - Open load (D5 = 1) Output peak current > 500mA - Open load (D5 = 0)
D4	Channel RF Turn-on diagnostic (D4 = 0) Permanent diagnostic (D4 = 1)
D3	Channel RF Normal load (D3 = 0) Short load (D3 = 1)
D2	Channel RF Turn-on diag.: No open load (D2 = 0) Open load detection (D2 = 1) Permanent diag.: No output offset (D2 = 0) Output offset detection (D2 = 1)
D1	Channel RF No short to Vcc (D1 = 0) Short to Vcc (D1 = 1)
D0	Channel RF No short to GND (D1 = 0) Short to GND (D1 = 1)

DB4

D7	X
D6	X
D5	Channel R Rcurrent detection Output peak current < 250mA - Open load (D5 = 1) Output peak current > 500mA - Open load (D5 = 0)
D4	Channel RR Turn-on diagnostic (D4 = 0) Permanent diagnostic (D4 = 1)
D3	Channel RR Normal load (D3 = 0) Short load (D3 = 1)
D2	Channel RR Turn-on diag.: No open load (D2 = 0) Open load detection (D2 = 1) Permanent diag.: No output offset (D2 = 0) Output offset detection (D2 = 1)
D1	Channel RR No short to Vcc (D1 = 0) Short to Vcc (D1 = 1)
D0	Channel RR No short to GND (D1 = 0) Short to GND (D1 = 1)

Examples of bytes sequence**1 - Turn-On diagnostic - Write operation**

Start	Address byte with D0 = 0	ACK	IB1 with D6 = 1	ACK	IB2	ACK	STOP
-------	--------------------------	-----	-----------------	-----	-----	-----	------

2 - Turn-On diagnostic - Read operation

Start	Address byte with D0 = 1	ACK	DB1	ACK	DB2	ACK	DB3	ACK	DB4	ACK	STOP
-------	--------------------------	-----	-----	-----	-----	-----	-----	-----	-----	-----	------

The delay from 1 to 2 can be selected by software, starting from T.B.D. ms

3a - Turn-On of the power amplifier with 26dB gain, mute on, diagnostic defeat.

Start	Address byte with D0 = 0	ACK	IB1	ACK	IB2	ACK	STOP
			X000000X		XXX1X0XX		

3b - Turn-Off of the power amplifier

Start	Address byte with D0 = 0	ACK	IB1	ACK	IB2	ACK	STOP
			X0XXXXXX		XXX0XXXX		

4 - Offset detection procedure enable

Start	Address byte with D0 = 0	ACK	IB1	ACK	IB2	ACK	STOP
			XX1XX11X		XXX1X0XX		

5 - Offset detection procedure stop and reading operation (the results are valid only for the offset detection bits (D2 of the bytes DB1, DB2, DB3, DB4).

Start	Address byte with D0 = 1	ACK	DB1	ACK	DB2	ACK	DB3	ACK	DB4	ACK	STOP
-------	--------------------------	-----	-----	-----	-----	-----	-----	-----	-----	-----	------

- The purpose of this test is to check if a D.C. offset (2V typ.) is present on the outputs, produced by input capacitor with anomalous leakage current or humidity between pins.
- The delay from 4 to 5 can be selected by software, starting from T.B.D. ms

6 - Current detection procedure start (the AC inputs must be with a proper signal that depends on the type of load)

Start	Address byte with D0 = 0	ACK	IB1	ACK	IB2	ACK	STOP
			XX01111X		XXX1X1XX		

7 - Current detection reading operation (the results valid only for the current sensor detection bits - D5 of the bytes DB1, DB2, DB3, DB4).

Start	Address byte with D0 = 1	ACK	DB1	ACK	DB2	ACK	DB3	ACK	DB4	ACK	STOP
-------	--------------------------	-----	-----	-----	-----	-----	-----	-----	-----	-----	------

- During the test, a sinus wave with a proper amplitude and frequency (depending on the loudspeaker under test) must be present. The minimum number of periods that are needed to detect a normal load is 5.
- The delay from 6 to 7 can be selected by software, starting from T.B.D. ms.

DIM.	mm			inch		
	MIN.	TYP.	MAX.	MIN.	TYP.	MAX.
A	4.45	4.50	4.65	0.175	0.177	0.183
B	1.80	1.90	2.00	0.070	0.074	0.079
C		1.40			0.055	
D	0.75	0.90	1.05	0.029	0.035	0.041
E	0.37	0.39	0.42	0.014	0.015	0.016
F (1)			0.57			0.022
G	0.80	1.00	1.20	0.031	0.040	0.047
G1	23.75	24.00	24.25	0.935	0.945	0.955
H (2)	28.90	29.23	29.30	1.139	1.150	1.153
H1		17.00			0.669	
H2		12.80			0.503	
H3		0.80			0.031	
L (2)	22.07	22.47	22.87	0.869	0.884	0.904
L1	18.57	18.97	19.37	0.731	0.747	0.762
L2 (2)	15.50	15.70	15.90	0.610	0.618	0.626
L3	7.70	7.85	7.95	0.303	0.309	0.313
L4		5			0.197	
L5		3.5			0.138	
M	3.70	4.00	4.30	0.145	0.157	0.169
M1	3.60	4.00	4.40	0.142	0.157	0.173
N		2.20			0.086	
O		2			0.079	
R		1.70			0.067	
R1		0.5			0.02	
R2		0.3			0.12	
R3		1.25			0.049	
R4		0.50			0.019	
V			5° (T p.)			
V1			3° (Typ.)			
V2			20° (Typ.)			
V3			45° (Typ.)			

(1): dam-bar protusion not included
 (2): molding protusion included

OUTLINE AND MECHANICAL DATA

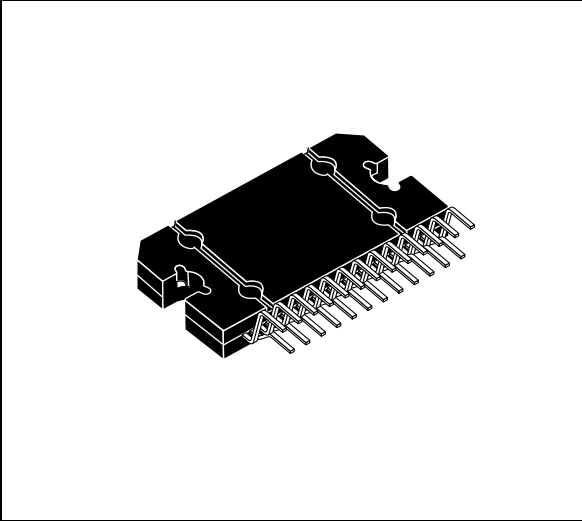

Flexiwatt25 (vertical)

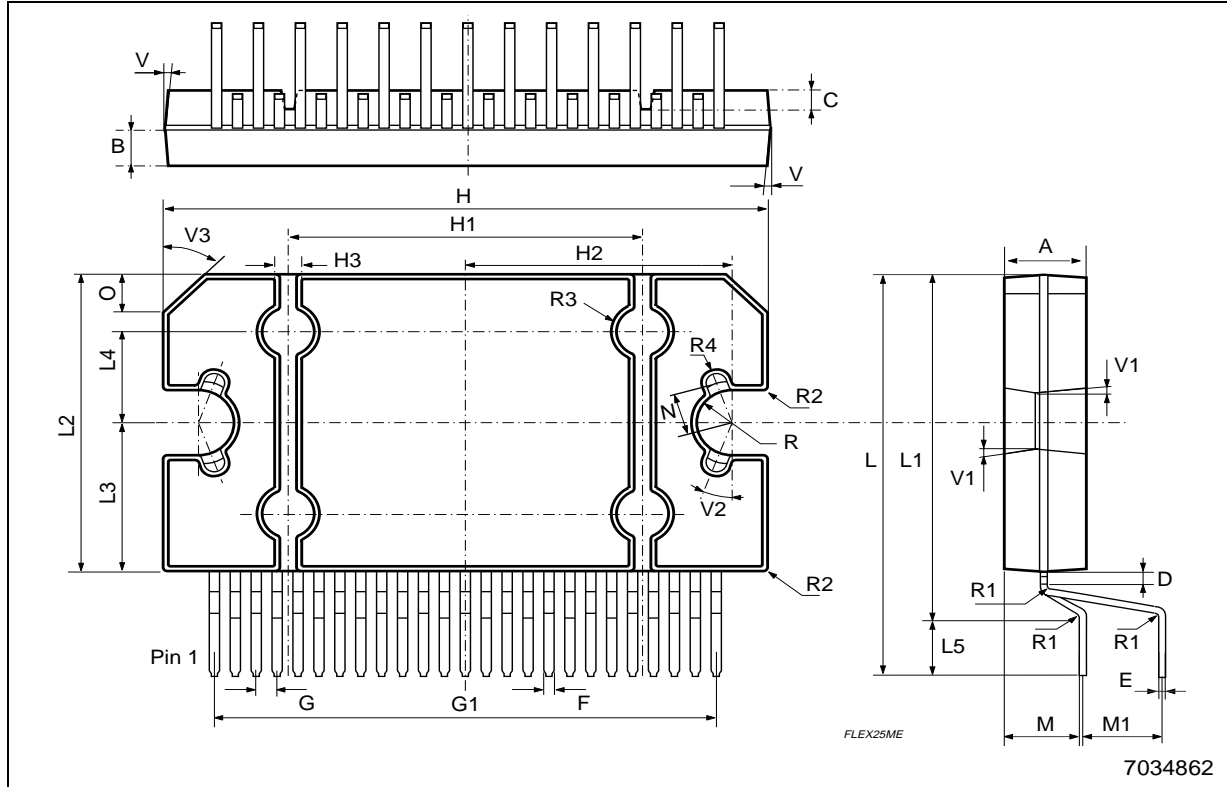

Information furnished is believed to be accurate and reliable. However, STMicroelectronics assumes no responsibility for the consequences of use of such information nor for any infringement of patents or other rights of third parties which may result from its use. No license is granted by implication or otherwise under any patent or patent rights of STMicroelectronics. Specifications mentioned in this publication are subject to change without notice. This publication supersedes and replaces all information previously supplied. STMicroelectronics products are not authorized for use as critical components in life support devices or systems without express written approval of STMicroelectronics.

The ST logo is a registered trademark of STMicroelectronics
© 2002 STMicroelectronics - All Rights Reserved

STMicroelectronics GROUP OF COMPANIES

Australia - Brazil - Canada - China - Finland - France - Germany - Hong Kong - India - Israel - Italy - Japan - Malaysia - Malta - Morocco -
Singapore - Spain - Sweden - Switzerland - United Kingdom - United States.

<http://www.st.com>