

2SC4056
(TP8V45FX)

8A NPN

OUTLINE DIMENSIONS

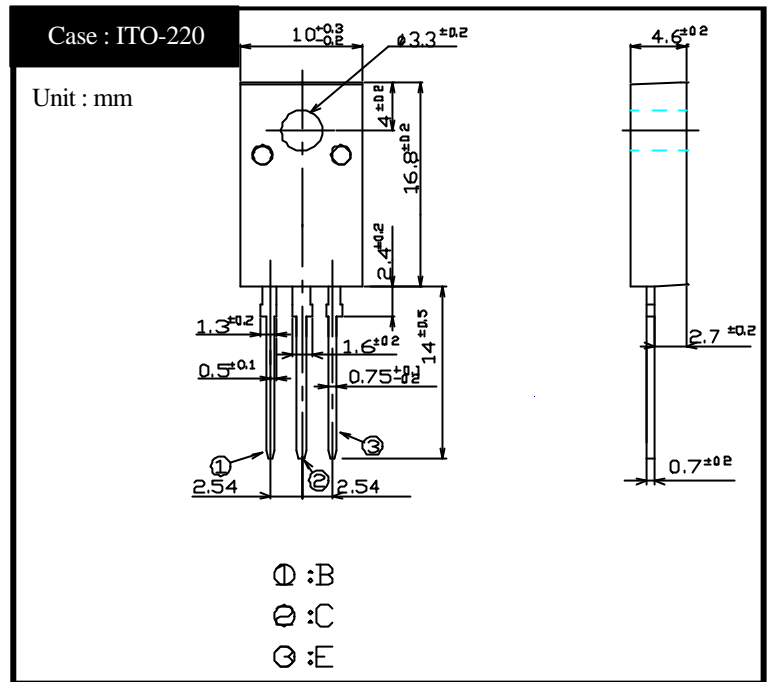

RATINGS

Absolute Maximum Ratings

Item	Symbol	Conditions	Ratings	Unit
Storage Temperature	T _{stg}		-55 ~ 150	
Junction Temperature	T _j		150	
Collector to Base Voltage	V _{CBO}		600	V
Collector to Emitter Voltage	V _{CEO}		450	V
	V _{CEX}	V _{EB} = 5V	600	
Emitter to Base Voltage	V _{EBO}		7	V
Collector Current DC	I _C		8	A
Collector Current Peak	I _{CP}		16	
Base Current DC	I _B		4	A
Base Current Peak	I _{BP}		8	
Total Transistor Dissipation	P _T	T _C = 25	45	W
Dielectric Strength	V _{dis}	Terminals to case, AC 1 minute	2	kV
Mounting Torque	TOR		0.5	N·m

Electrical Characteristics (T_C=25)

Item	Symbol	Conditions	Ratings	Unit
Collector to Emitter Sustaining Voltage	V _{CEO(sus)}	I _C = 0.2A	Min 450	V
Collector Cutoff Current	I _{CBO}	At rated Voltage	Max 0.1	mA
	I _{CEO}		Max 0.1	
Emitter Cutoff Current	I _{EBO}	At rated Voltage	Max 0.1	mA
DC Current Gain	h _{FE}	V _{CE} = 5V, I _C = 4A	Min 10	
	h _{FEL}	V _{CE} = 5V, I _C = 1mA	Min 5	
Collector to Emitter Saturation Voltage	V _{CE(sat)}	I _C = 4A	Max 1.0	V
Base to Emitter Saturation Voltage	V _{BE(sat)}	I _B = 0.8A	Max 1.5	V
Thermal Resistance	θ _{JC}	Junction to case	Max 2.77	/W
Transition Frequency	f _T	V _{CE} = 10V, I _C = 0.8A	STD 20	MHz
Turn on Time	t _{on}	I _C = 4A	Max 0.5	μs
Storage Time	t _s	I _{B1} = 0.8A, I _{B2} = 1.6A	Max 2.0	
Fall Time	t _f	R _L = 37.5 , V _{BB2} = 4V	Max 0.2	

2SC4056

$h_{FE} - I_C$

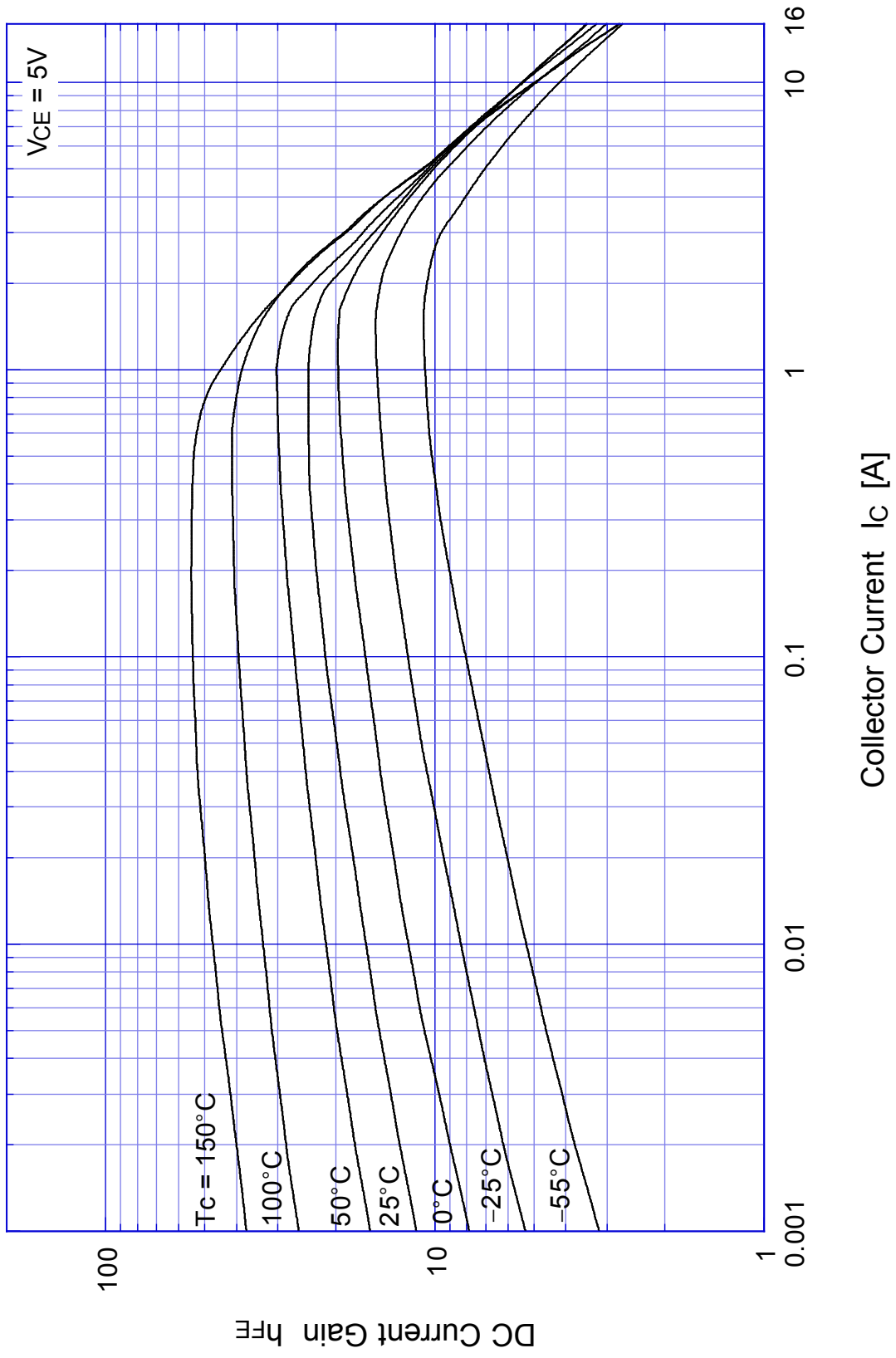

2SC4056 Saturation Voltage

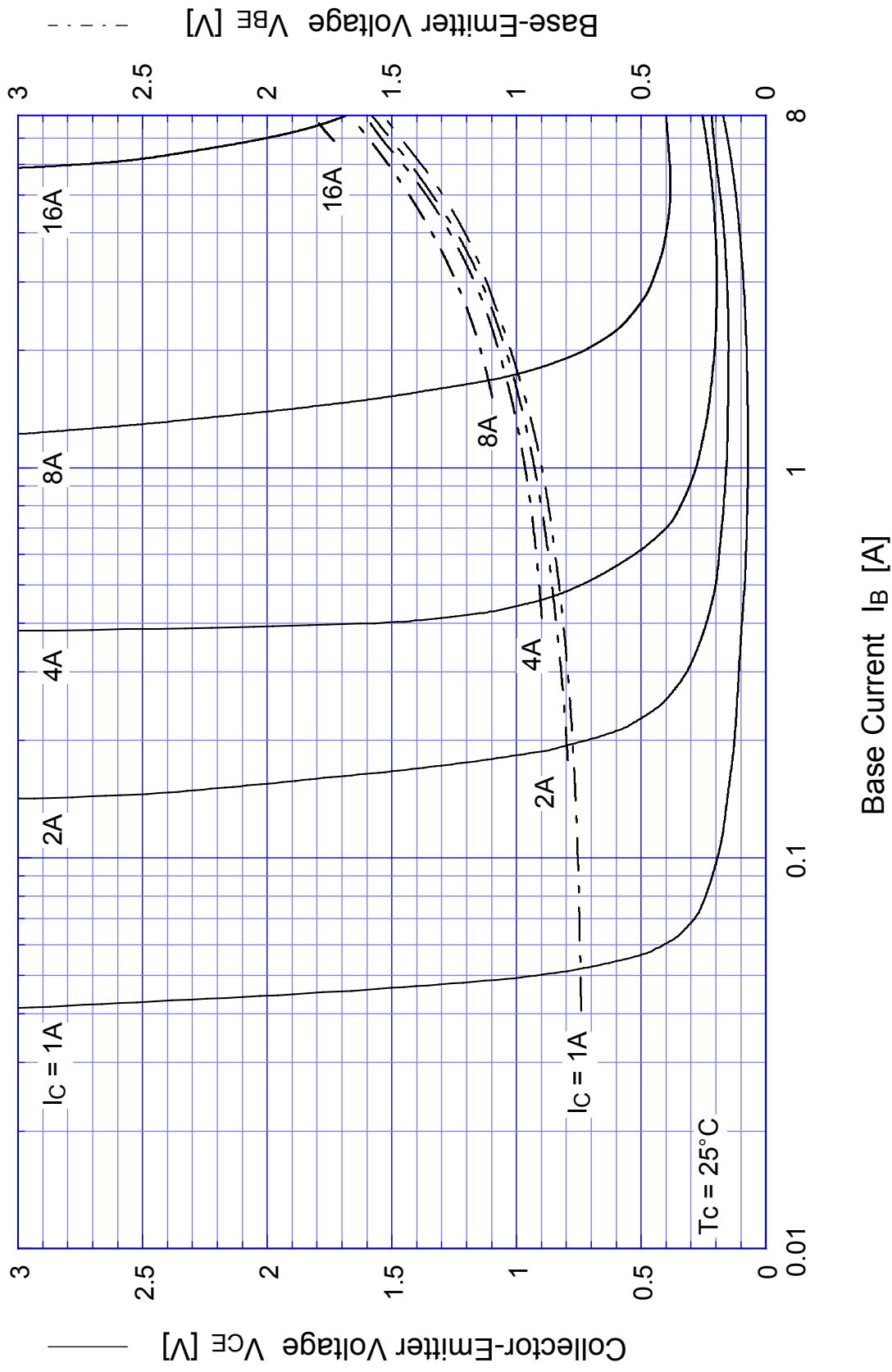

2SC4056

Switching Time - I_C

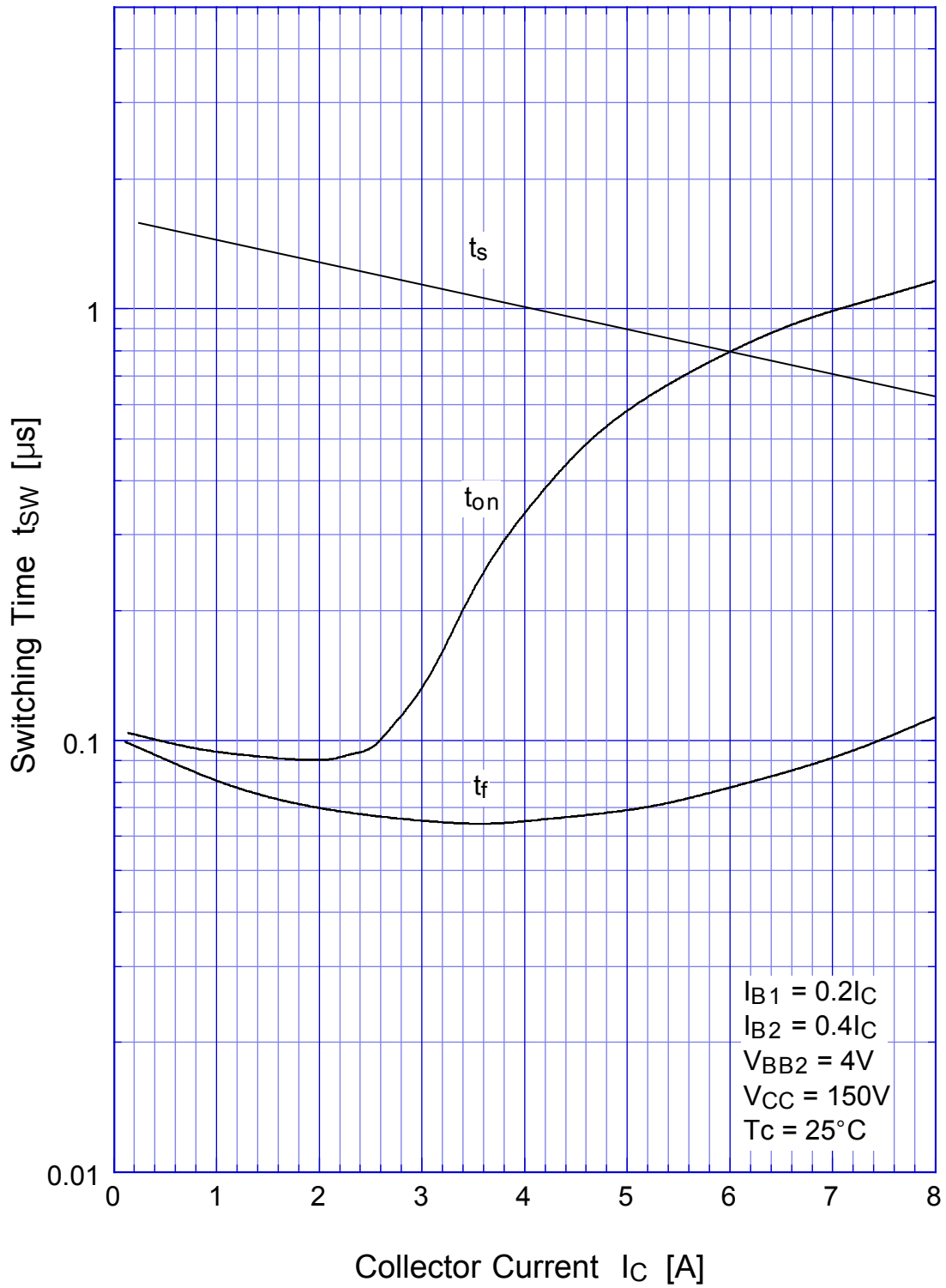

2SC4056 Switching Time - V_{CC}

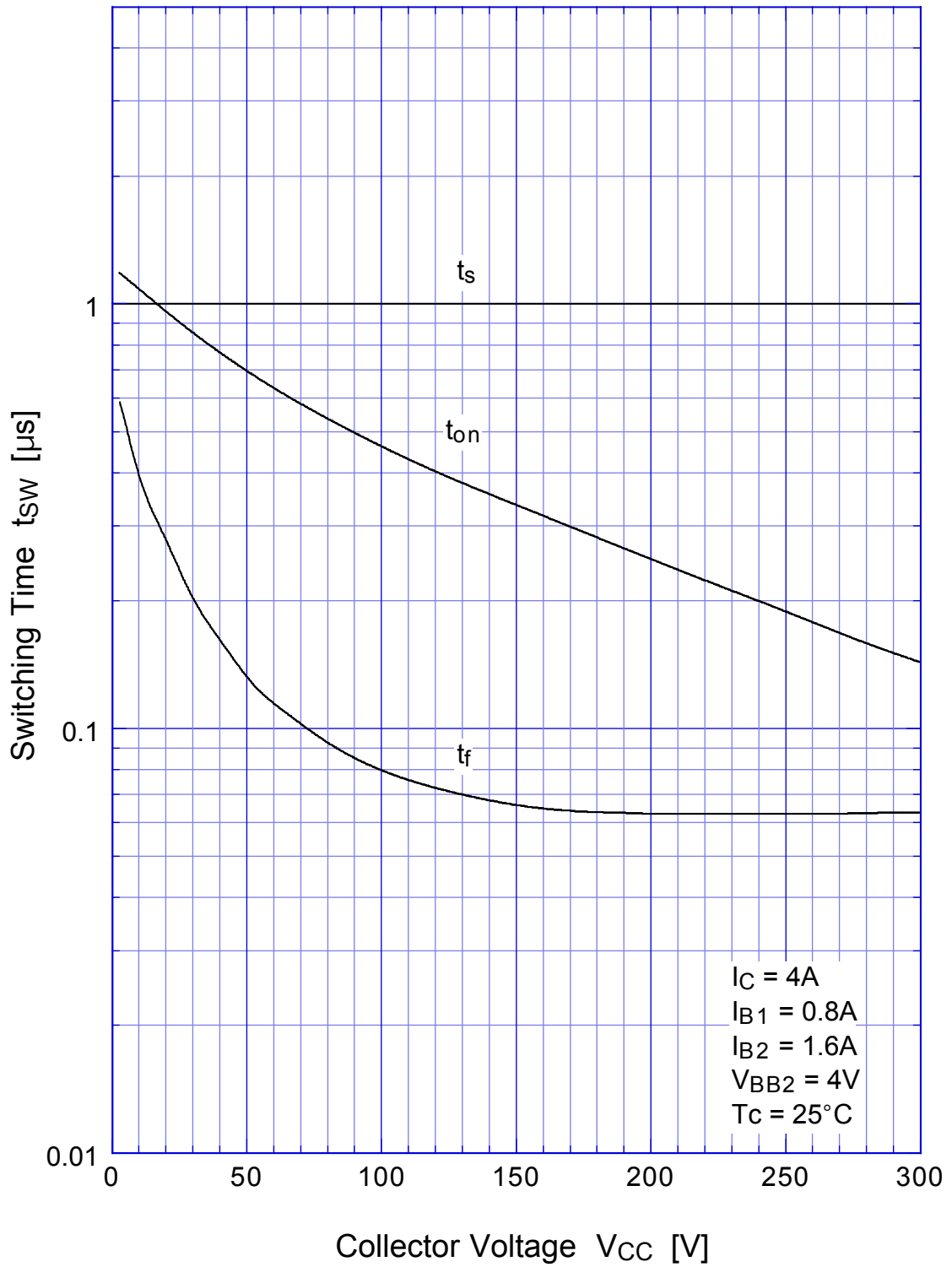

2SC4056

Switching Time - Tc

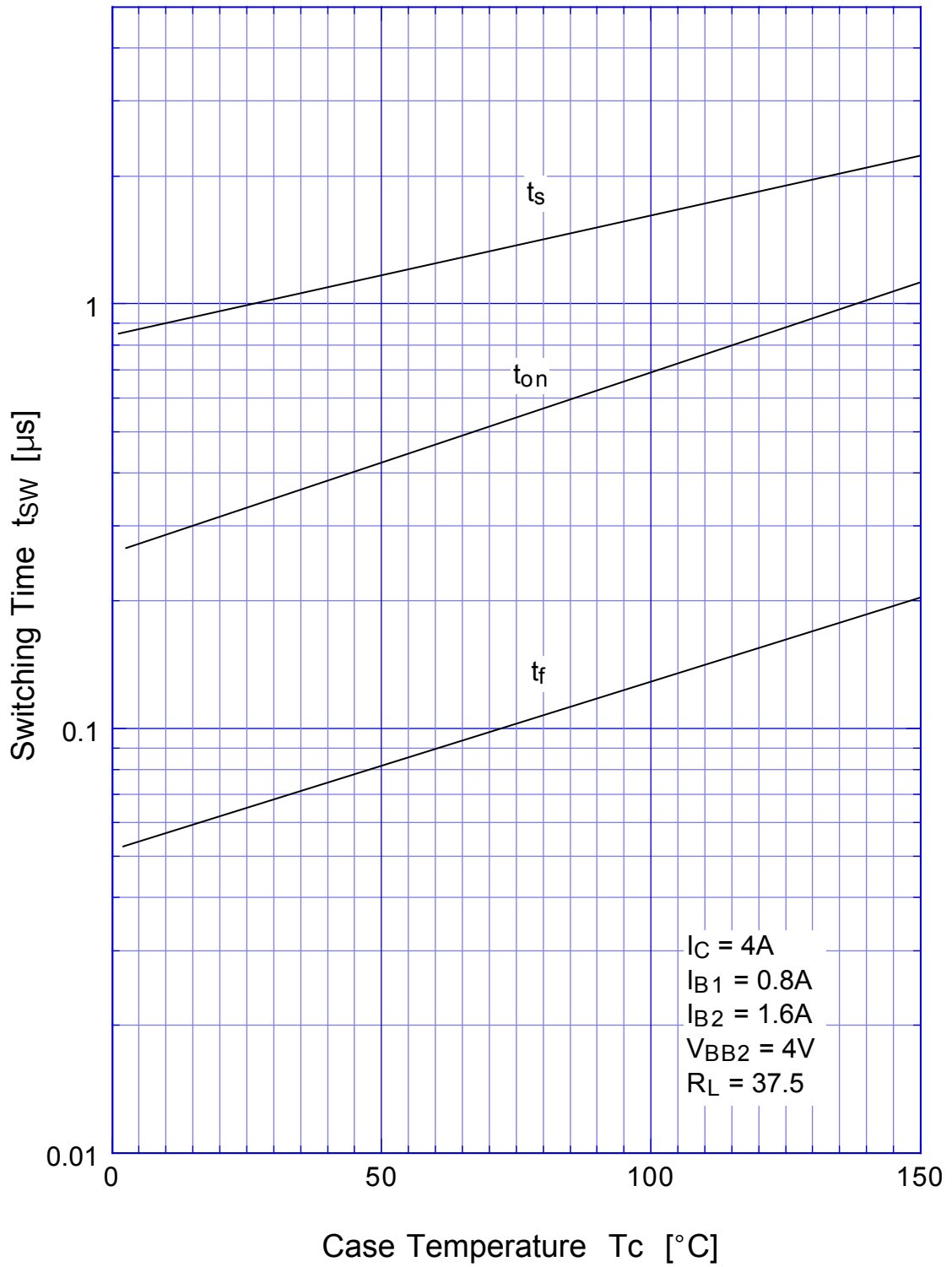

2SC4056 L-Load Switching Time - I_C

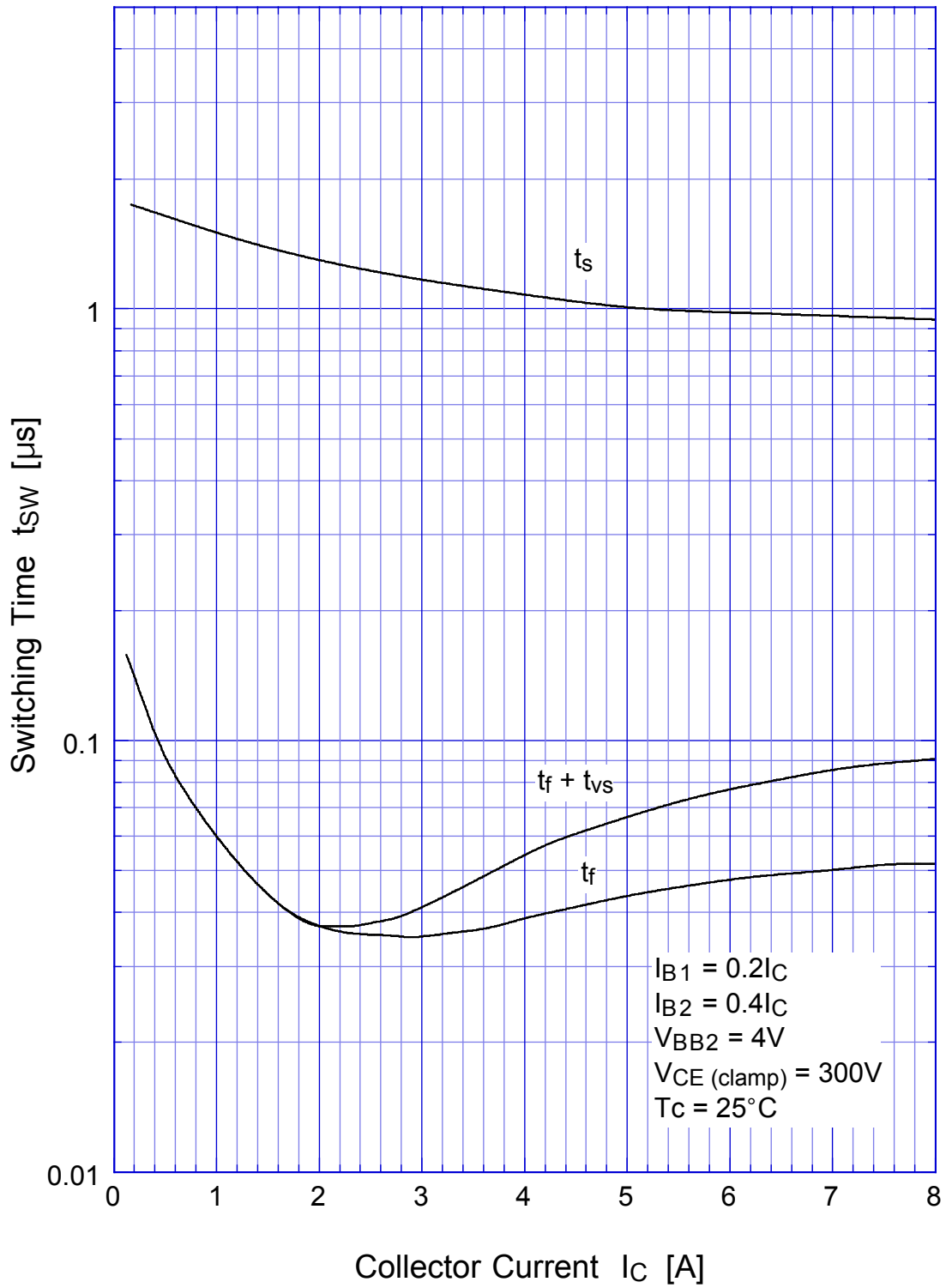

2SC4056 L-Load Switching Time - I_C (At High Temperature)

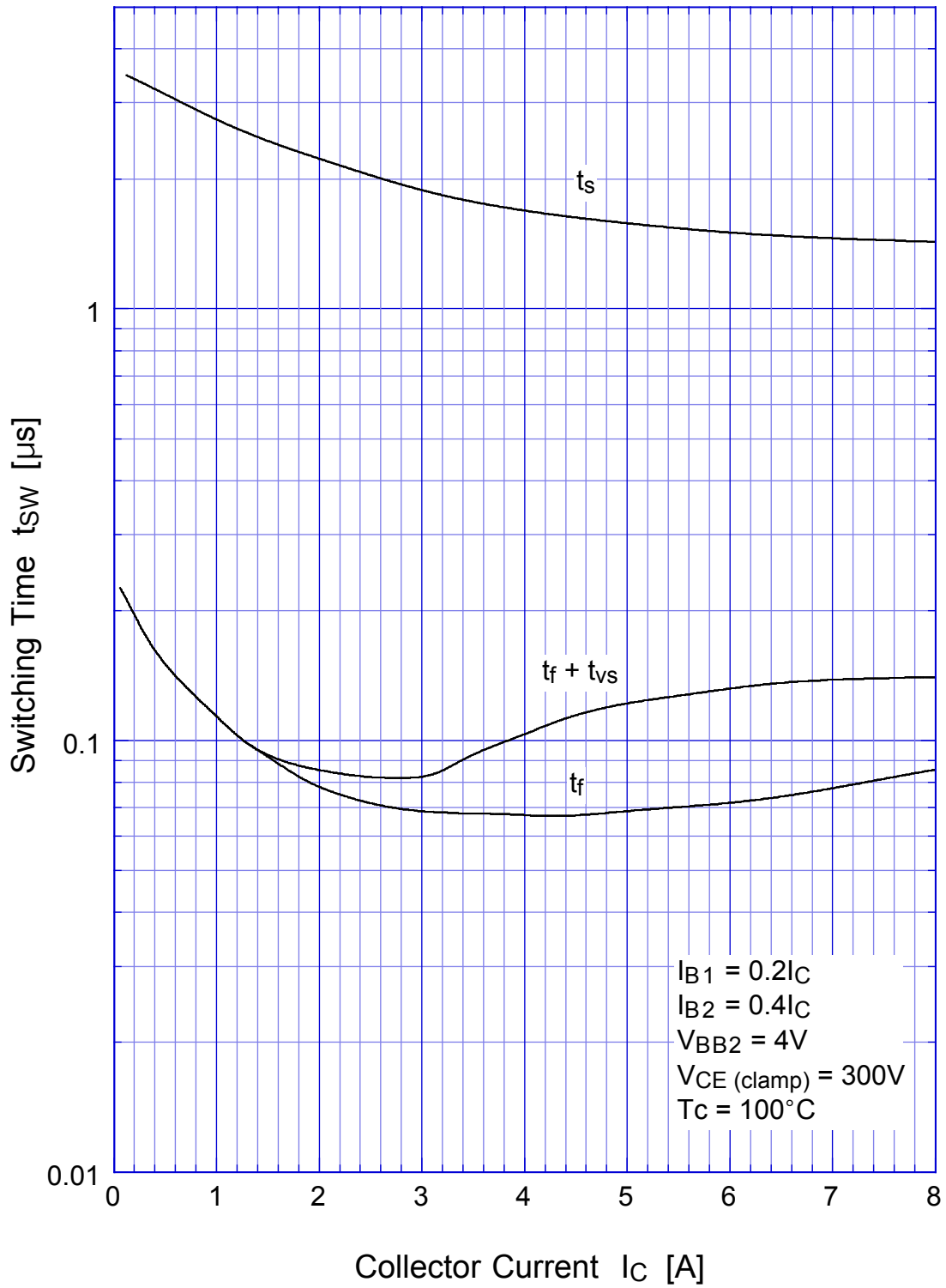

2SC4056 Transient Thermal Impedance

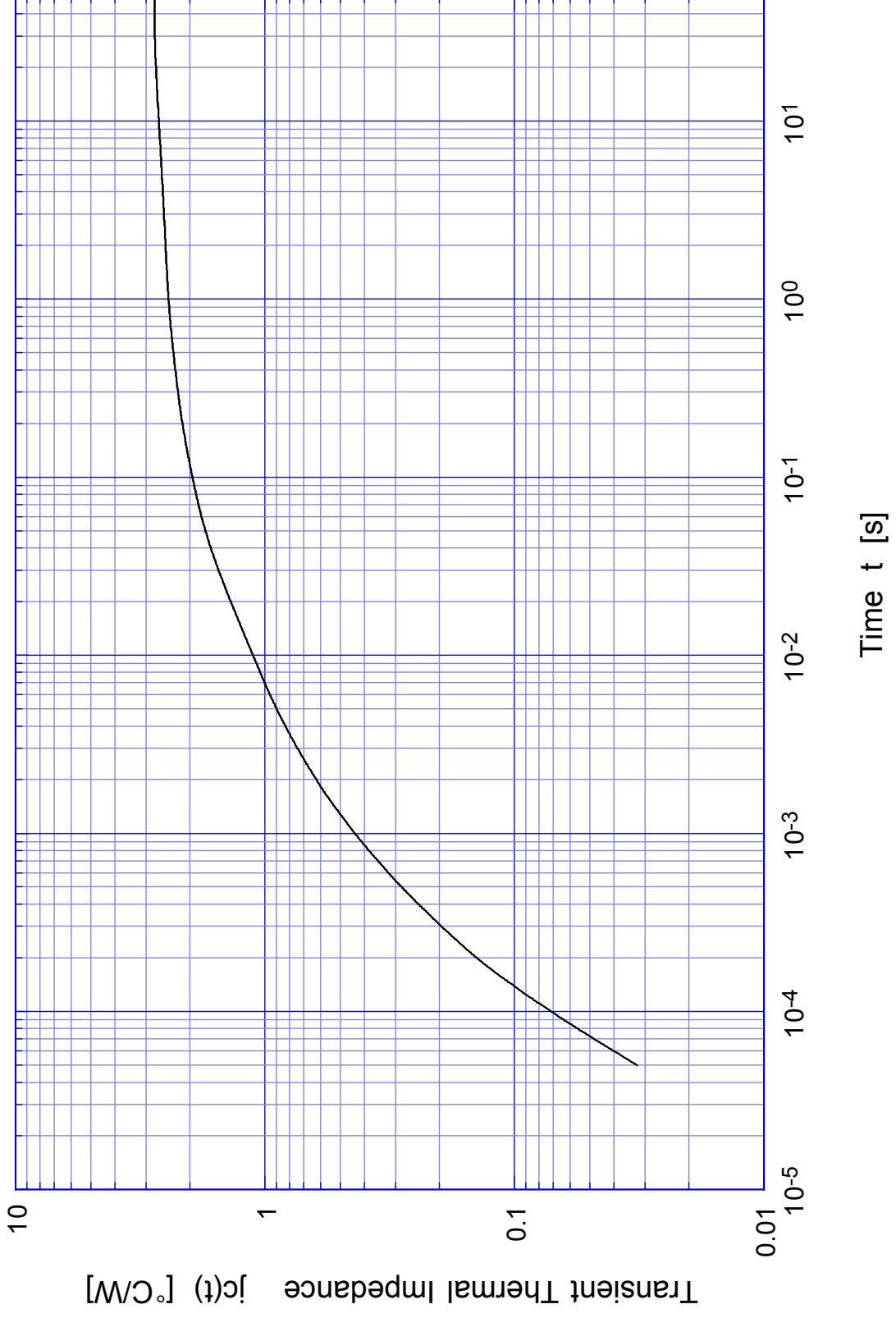

2SC4056

Forward Bias SOA

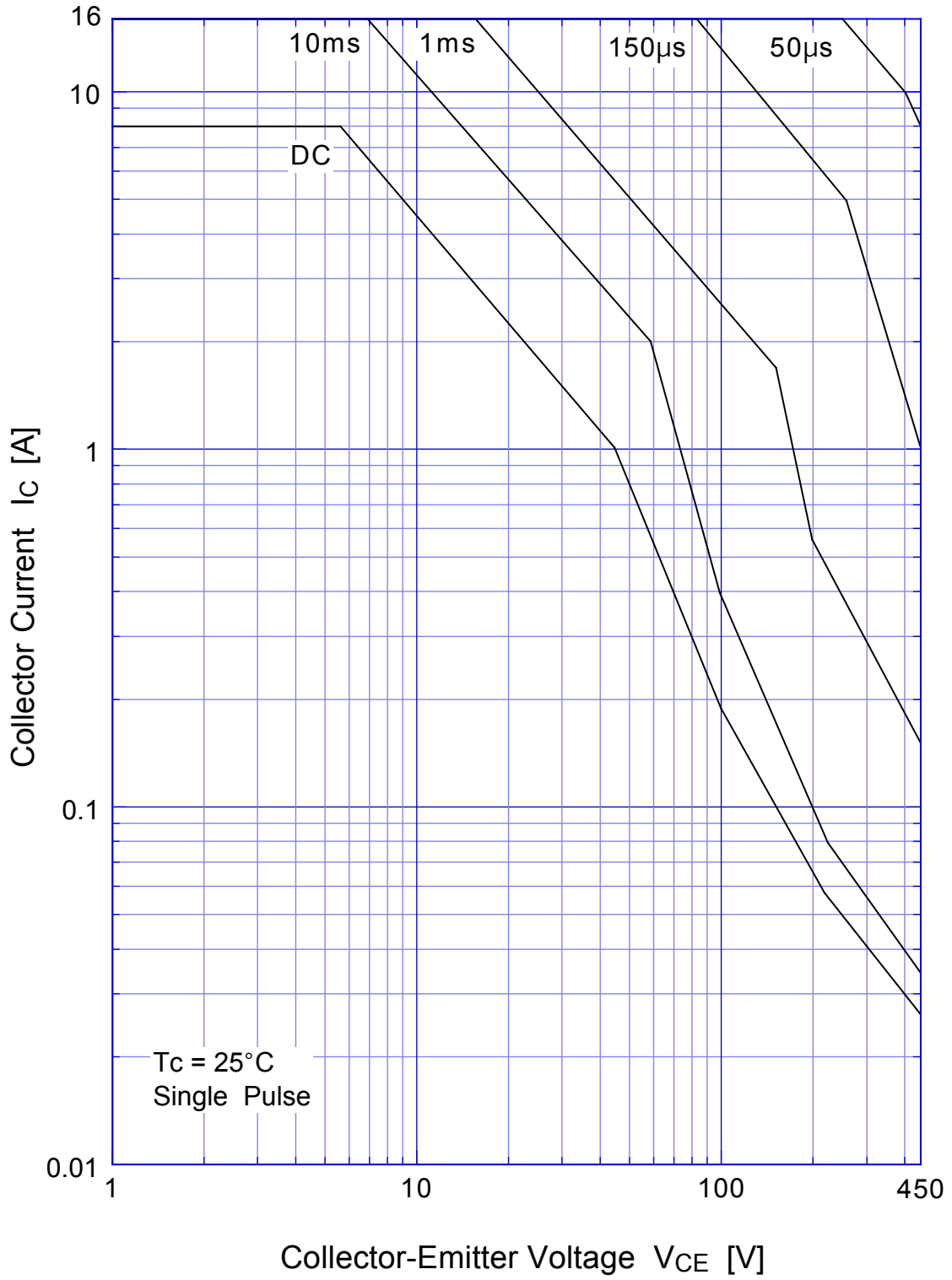

2SC4056 Collector Current Derating



2SC4056

Reverse Bias SOA

