

**SANYO**

No. 4863

**LC7536R****High Breakdown Voltage Serial Control  
Electronic Volume Control****Overview**

The LC7536R is an electronic volume control IC that implements volume and balance functions with a minimum number of external components.

**Features**

- The LC7536R is controlled by a 3-wire (DI, CL and CE) serial data control scheme that can be shared with other ICs. Up to two LC7536Rs can be used on the same bus by using the S (select) pin.
- Eighty positions in 1 dB steps plus mute ( $-\infty$ ), maximum attenuation is over 80 dB
- Input impedance (5 dB inputs): 47 k $\Omega$  (typical)
- High breakdown voltage:  $\pm 16$  V

**Package Dimensions**

unit: mm

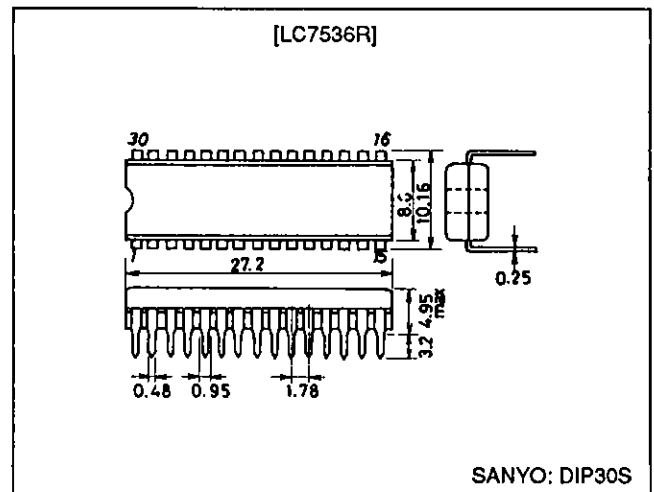
**3047A-DIP30S****Specifications**

**Absolute Maximum Ratings at  $T_a = 25^\circ\text{C}$ ,  $V_{SS} = 0$  V**

Parameter	Symbol	Conditions	Ratings	Unit
Maximum supply voltage	$V_{DD}$ max	$V_{EE} \leq V_{SS} < V_{CC} < V_{DD}$	$V_{SS}$ to $V_{SS} + 18$	V
	$V_{EE}$ max	$V_{EE} \leq V_{SS} < V_{CC} < V_{DD}$	$V_{SS} - 18$ to $V_{SS}$	V
	$V_{CC}$ max	$V_{EE} \leq V_{SS} < V_{CC} < V_{DD}$	$V_{SS}$ to $V_{SS} + 7$	V
Input voltage	$V_{I1}$	CL, DI, CE	0 to $V_{DD} + 0.3$	V
	$V_{I2}$	IN1, IN2	$V_{EE} - 0.3$ to $V_{DD} + 0.3$	V
	$V_{I3}$	S	$V_{CC} - 0.3$ to $V_{DD} + 0.3$	V
Allowable power dissipation	$P_d$ max	$T_a \leq 75^\circ\text{C}$	250	mW
Operating temperature	$T_{opr}$		-30 to +75	$^\circ\text{C}$
Storage temperature	$T_{stg}$		-40 to +125	$^\circ\text{C}$

## LC7536R

### Allowable Operating Ranges at $T_a = 25^\circ\text{C}$ , $V_{SS} = 0\text{ V}$

Parameter	Symbol	Conditions	min	typ	max	Unit
Supply voltage	$V_{DD}$		$V_{CC} + 4.5$		16	V
	$V_{EE}$		-16		0	V
	$V_{CC}$		4.5	5	5.5	V
Input high level voltage	$V_{IH1}$	CL, DI, CE	$0.8 V_{CC}$		$V_{CC}$	V
Input low level voltage	$V_{IL1}$	CL, DI, CE	$V_{SS}$		$0.2 V_{CC}$	V
Input high level voltage	$V_{IH2}$	S	$0.8 \times (V_{DD} - V_{CC}) + V_{CC}$		$V_{DD}$	V
Input low level voltage	$V_{IL2}$	S	$V_{CC}$		$0.2 \times (V_{DD} - V_{CC}) + V_{CC}$	V
Input pulse width	$t_{\text{pw}}$	CL	1			$\mu\text{s}$
Setup time	$t_{\text{set up}}$	CL, DI, CE	1			$\mu\text{s}$
Hold time	$t_{\text{hold}}$	CL, DI, CE	1			$\mu\text{s}$
Operating frequency	$f_{\text{opg}}$	CL			500	kHz
Input signal amplitude	$V_{IN}$	IN1, IN2	$V_{EE}$		$V_{DD}$	V
Input leakage current	$I_{IN}$	CL, DI, CE, S	-10		+10	$\mu\text{A}$

### Electrical Characteristics at $T_a = 25^\circ\text{C}$ , $V_{SS} = 0\text{ V}$

Parameter	Symbol	Conditions	min	typ	max	Unit
Current drain	$I_{DD}$				1	mA
	$I_{CC}$				1	mA
Output off leakage current	$I_{OFF}$	IN1, IN2, $V_{M1}$ , $V_{M2}$ , CT1, CT2, OUT1, OUT2, analog switch off	-10		+10	$\mu\text{A}$
Total harmonic distortion	THD1	$V_{IN} = 1\text{ Vrms}$ , $f = 1\text{ kHz}$ , $V_{DD} - V_{EE} = 32\text{ V}$ , $V_R = \text{max}$		0.004		%
	THD2	$V_{IN} = 0.1\text{ Vrms}$ , $f = 1\text{ kHz}$ , $V_{DD} - V_{EE} = 32\text{ V}$ , $V_R = \text{max}$		0.02		%
Inter-channel crosstalk	$C_T$	OUT1 and OUT2, with a 20 kHz 1 Vrms input to one channel		-75	-60	dB
Output at maximum attenuation	$V_O$	$f = 20\text{ kHz}$ , $V_{IN} = 1\text{ Vrms}$		-98		dB

### Pin Assignment

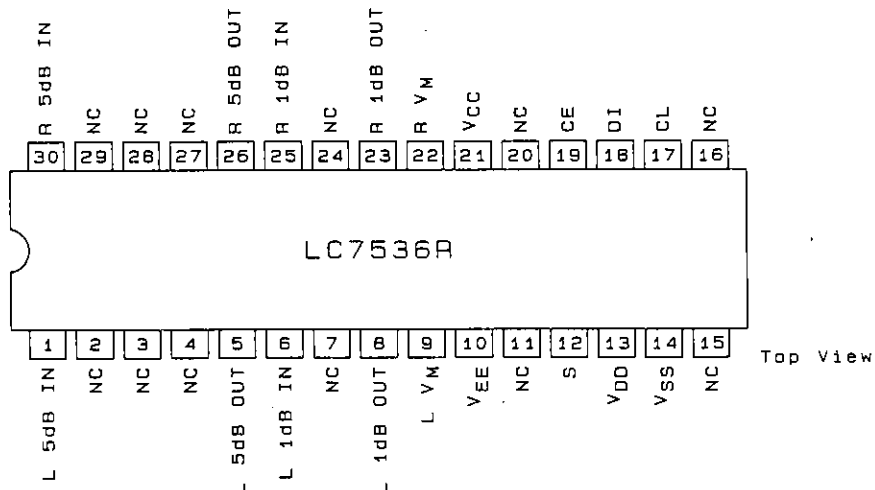

A02486

Equivalent Circuit Block Diagram

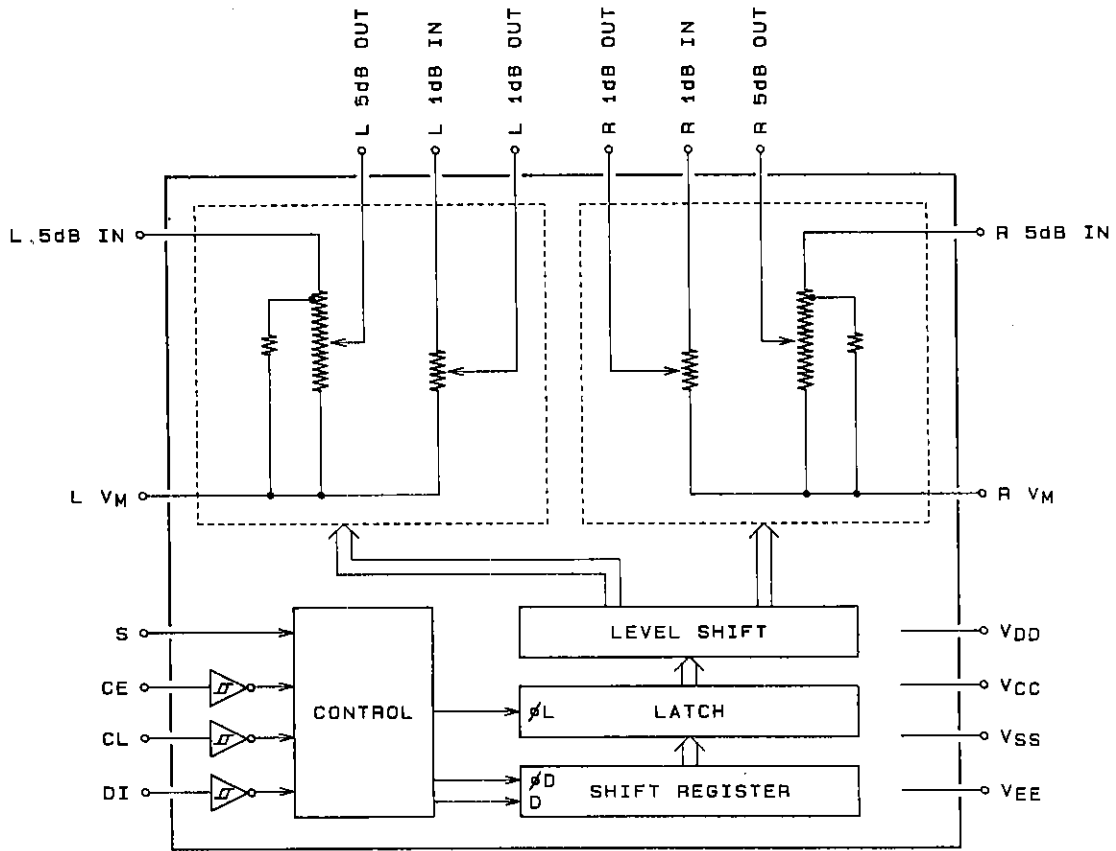

A02487

Internal Resistor Equivalent Circuit Diagram

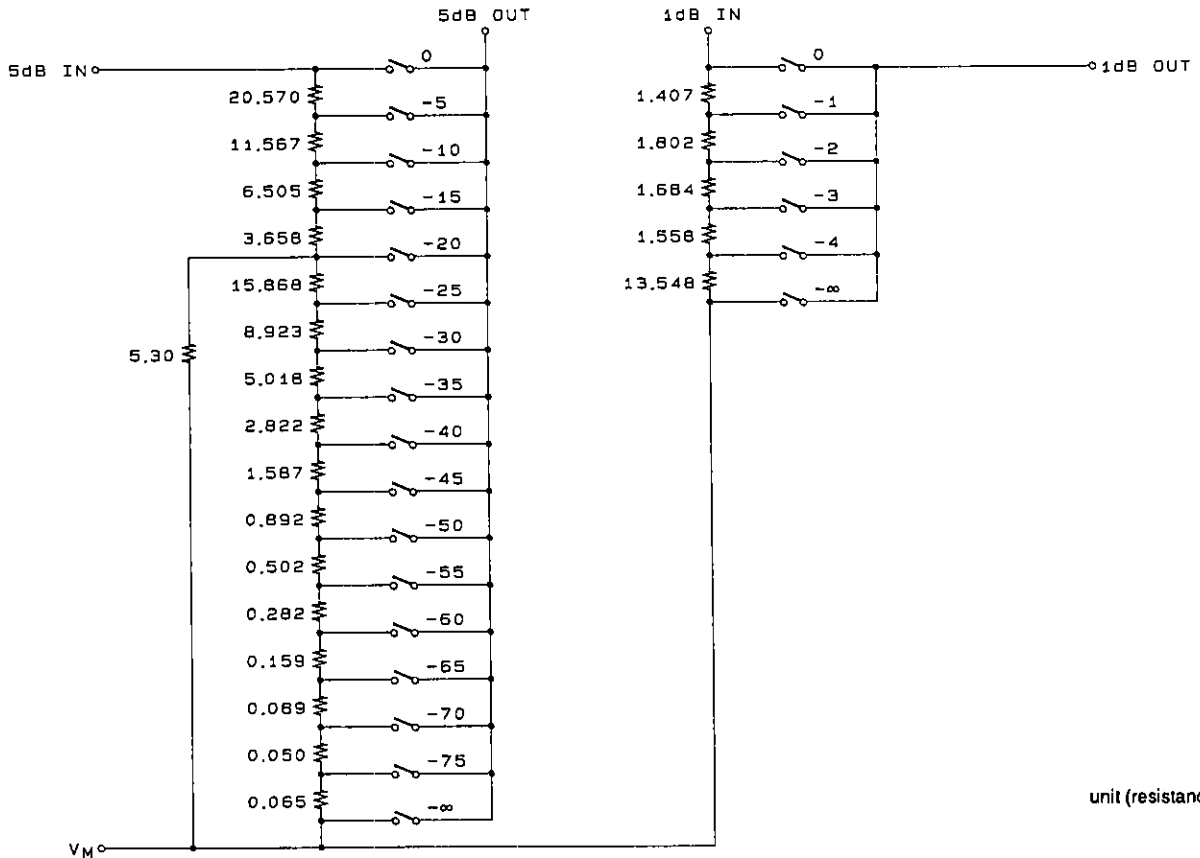

unit (resistance: KΩ)

A02488

## LC7536R

### Pin Functions

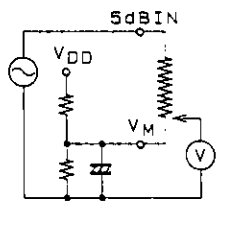
Pin No.	Symbol	Function	Note
1	L 5dBIN	Inputs to the 5 dB step attenuator. Must be driven by low impedance outputs.	
30	R 5dBIN		
3	NC		
4	NC		
28	NC		
27	NC	No connection	
5	L 5dBOUT	Outputs from the 5 dB step attenuator. Outputs should be received by a load of about 1 MΩ.	
26	R 5dBOUT		
6	L 1dBIN	Inputs to the 1 dB step attenuator. Must be driven by low impedance outputs.	
25	R 1dBIN		
8	L 1dBOUT	Outputs from the 1 dB step attenuator. Outputs should be received by a load in the range 47 kΩ to 1 MΩ.	
23	R 1dBOUT		
9	L V <sub>M</sub>	Volume control common connections. The impedance of the pattern connected to these pins should be lowered as far as possible. Since LV <sub>M</sub> , RV <sub>M</sub> and V <sub>SS</sub> are not connected internally, they should be connected externally according to their respective specifications. In particular, when a single-sided power supply is used, the capacitor connected between V <sub>M</sub> and V <sub>SS</sub> appears as the residual resistance when the volume is attenuated. Thus care is required when selecting the value for this capacitor.	
22	R V <sub>M</sub>		
12	S	Selection pin for the address code in the data format. When this pin is connected to V <sub>DD</sub> , the LC7536R will accept data when the address code is 9 and when connected to V <sub>CC</sub> , the LC7536R will accept data when the address code is 8.	
17	CL	Inputs for controlling the LC7536R from serial data. Signals should have an amplitude of 0 to 5 V.	
18	DI		
19	CE		
10	V <sub>EE</sub>	Power supply connections. Do not bring up the V <sub>CC</sub> voltage before the V <sub>DD</sub> voltage when powering up the LC7536R.	
13	V <sub>DD</sub>		
14	V <sub>SS</sub>		
21	V <sub>CC</sub>		
2, 7, 11, 15, 16, 20, 24, 29	NC	No connection	

Data Format

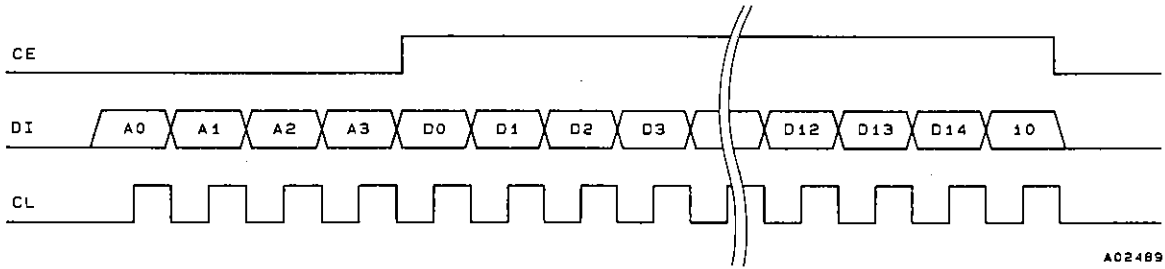

A02489

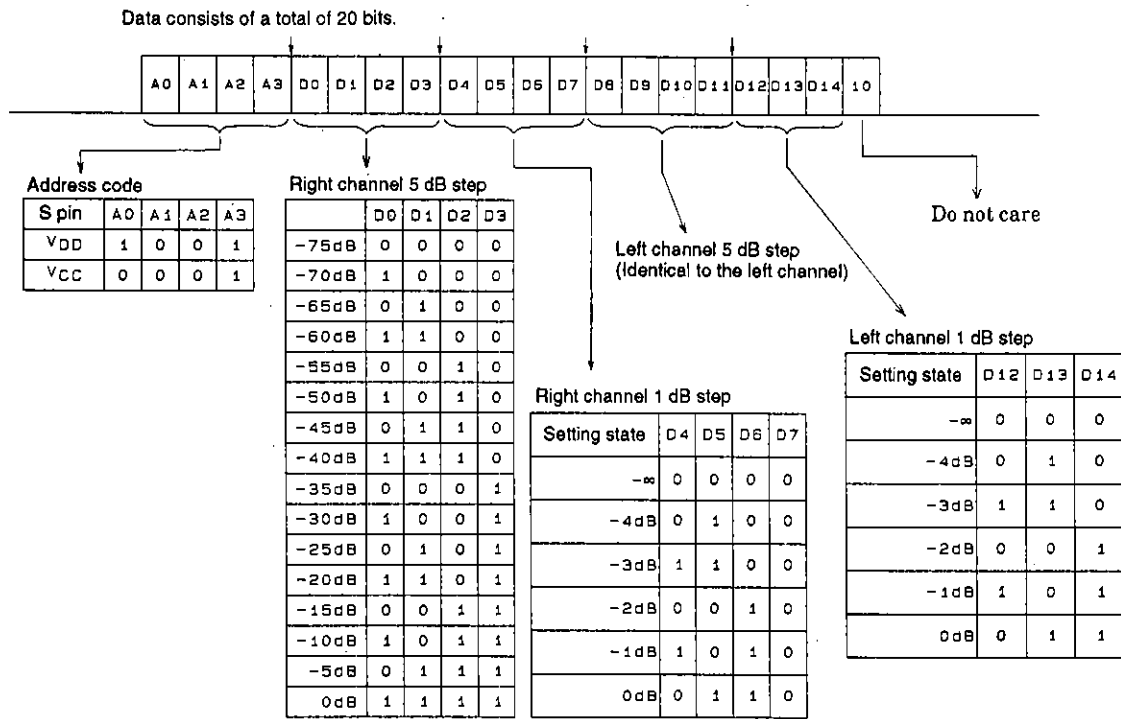

A02490

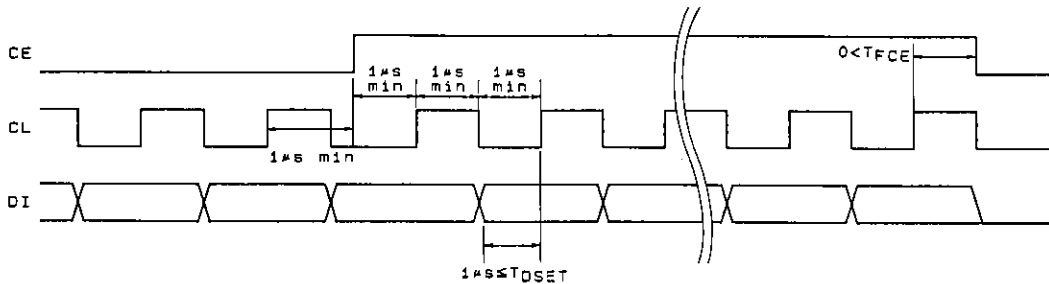

A02491

# LC7536R

## Sample Application Circuit

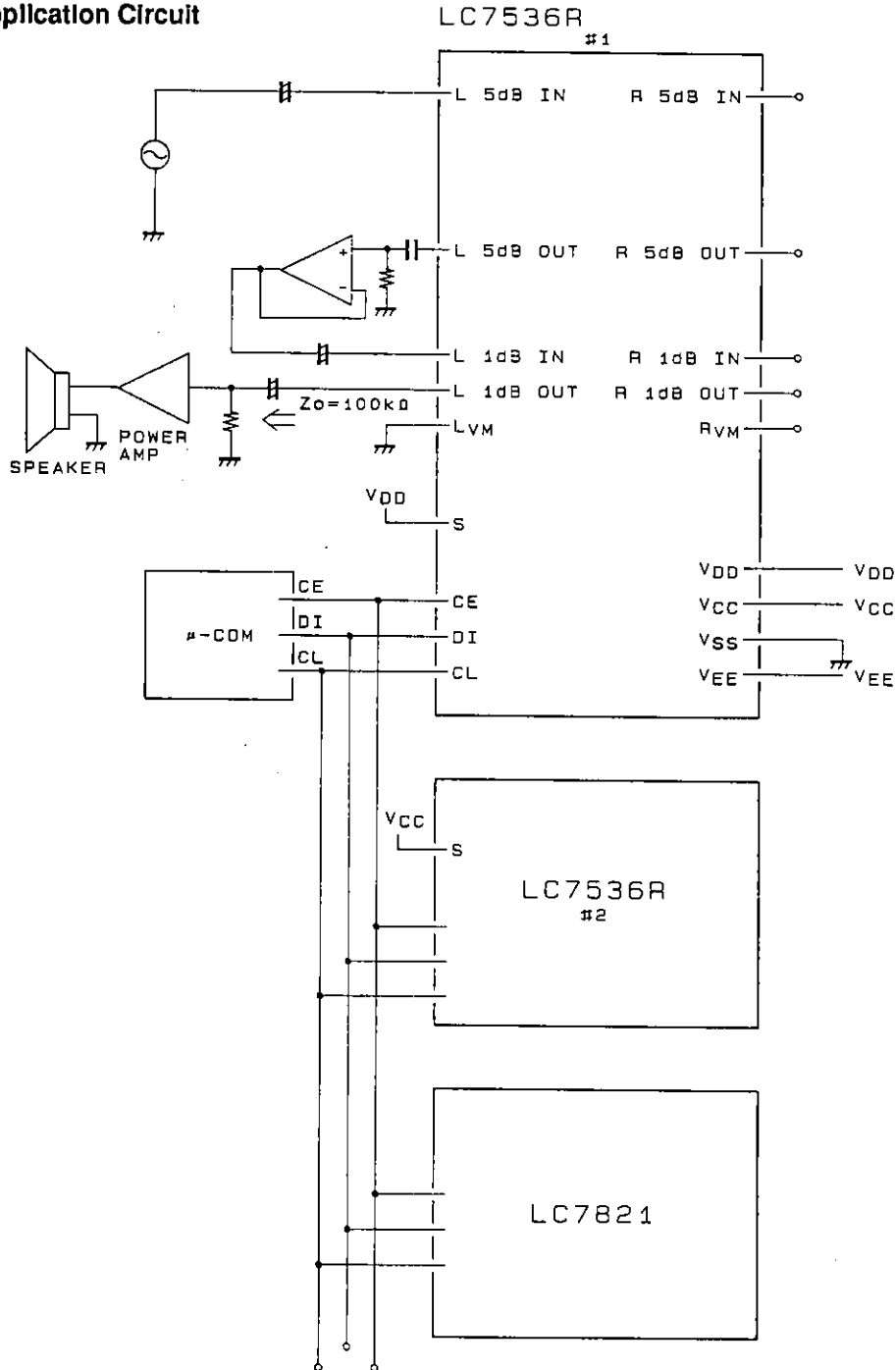

A02492

■ No products described or contained herein are intended for use in surgical implants, life-support systems, aerospace equipment, nuclear power control systems, vehicles, disaster/crime-prevention equipment and the like, the failure of which may directly or indirectly cause injury, death or property loss.

■ Anyone purchasing any products described or contained herein for an above-mentioned use shall:

- ① Accept full responsibility and indemnify and defend SANYO ELECTRIC CO., LTD., its affiliates, subsidiaries and distributors and all their officers and employees, jointly and severally, against any and all claims and litigation and all damages, cost and expenses associated with such use;
- ② Not impose any responsibility for any fault or negligence which may be cited in any such claim or litigation on SANYO ELECTRIC CO., LTD., its affiliates, subsidiaries and distributors or any of their officers and employees jointly or severally.

■ Information (including circuit diagrams and circuit parameters) herein is for example only; it is not guaranteed for volume production. SANYO believes information herein is accurate and reliable, but no guarantees are made or implied regarding its use or any infringements of intellectual property rights or other rights of third parties.