

# DATA SHEET

## **TDA1572T** AM receiver

Product specification  
File under Integrated Circuits, IC01

May 1992

## AM receiver

## TDA1572T

## GENERAL DESCRIPTION

The TDA1572T integrated AM receiver circuit performs all the active functions and part of the filtering required of an AM radio receiver. It is intended for use in mains-fed home receivers and car radios. The circuit can be used for oscillator frequencies up to 50 MHz and can handle RF signals up to 500 mV.

RF radiation and sensitivity to interference are minimized by an almost symmetrical design. The controlled-voltage oscillator provides signals with extremely low distortion and high spectral purity over the whole frequency range, even when tuning with variable capacitance diodes. If required, band switching diodes can easily be applied. Selectivity is obtained using a block filter before the IF amplifier.

## Features

- Inputs protected against damage by static discharge
- Gain-controlled RF stage
- Double balanced mixer
- Separately buffered, voltage-controlled and temperature-compensated oscillator, designed for simple coils
- Gain-controlled IF stage with wide AGC range
- Full-wave, balanced envelope detector
- Internal generation of AGC voltage with possibility of second-order filtering
- Buffered field strength indicator driver with short-circuit protection
- AF preamplifier with possibilities for simple AF filtering
- Electronic standby switch
- IF output for stereo demodulator and search tuning.

## QUICK REFERENCE DATA

SYMBOL	PARAMETER	CONDITIONS	MIN.	TYP.	MAX.	UNIT
$V_P$	Supply voltage range		7.5	8.5	14.0	V
$I_P$	Supply current range	$V_P = 8.5\text{ V}$	15	25	28	mA
$V_{iFR(rms)}$	RF input voltage (RMS value) for $(S + N)/N = 6\text{ dB}$	$m = 30\%$	–	1.5	–	$\mu\text{V}$
$V_{iRF(rms)}$	for $\text{THD} = 3\%$	$m = 80\%$	–	500	–	mV
$V_{oIF(rms)}$	IF output voltage (RMS value)	$V_i = 2\text{ mV(rms)}$	180	230	290	mV
	AF output voltage (RMS value)	$V_i = 2\text{ mV(rms)}$ ; $f_i = 1\text{ MHz}$ ; $m = 30\%$ ; $f_m = 400\text{ Hz}$	240	310	390	mV
	<b>AGC range</b>					
$\Delta V_i$	Change of $V_i$ for 1 dB change of $V_{oAF}$		–	86	–	dB
	<b>Indicator driver (pin 13)</b>					
$V_o$	Output voltage	$V_i = 500\text{ mV(rms)}$ ; $R_L = 2.7\text{ k}\Omega$	2.5	2.8	3.1	V

## PACKAGE OUTLINE

20-lead mini-pack; plastic (SO20; SOT163A); SOT163-1; 1996 August 13.

AM receiver

TDA1572T

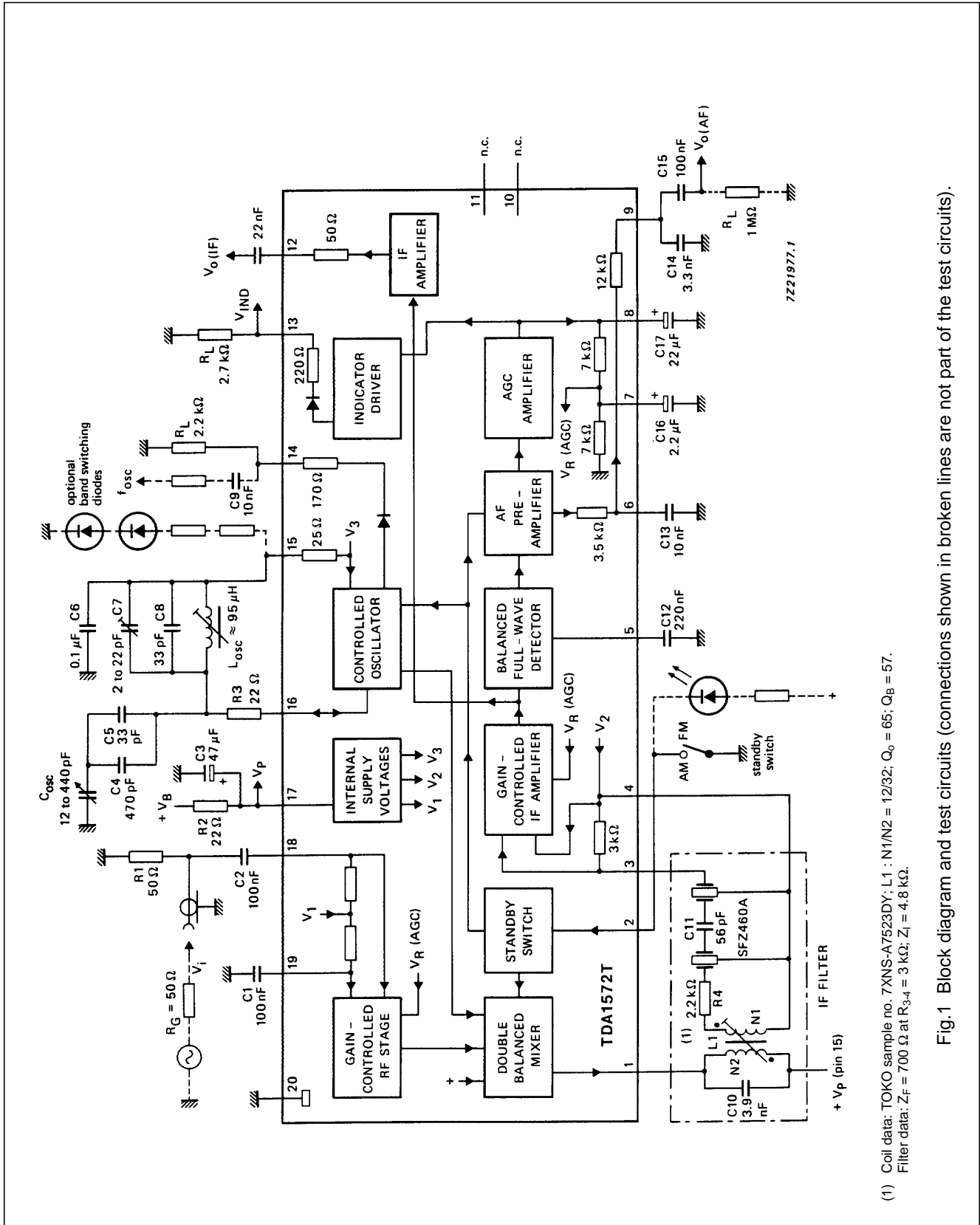

(1) Coil data: TOKO sample no. 7XNS-A7523DY; L1 : N1/N2 = 12/32; Q<sub>0</sub> = 65; Q<sub>B</sub> = 57.  
Filter data: Z<sub>F</sub> = 700  $\Omega$  at R<sub>3-4</sub> = 3 k $\Omega$ ; Z<sub>1</sub> = 4.8 k $\Omega$ .

Fig.1 Block diagram and test circuits (connections shown in broken lines are not part of the test circuits).

AM receiver

TDA1572T

**PINNING**

1	MXO	mixer output
2	STB	standby switch
3	IF11	IF input 1
4	IF12	IF input 2
5	DET	detector
6	AFO1	AF output 1
7	AGC1	AGC stage 1
8	ACG2	AGC stage 2
9	AFO2	AF output 2
10	n.c.	not connected
11	n.c.	not connected
12	IFO	IF output
13	IND	indicator output
14	OSO	buffered oscillator output
15	OSC1	oscillator 1
16	OSC2	oscillator 2
17	V <sub>P</sub>	supply voltage
18	RF11	RF input 1
19	RF12	RF input 2
20	GND	ground

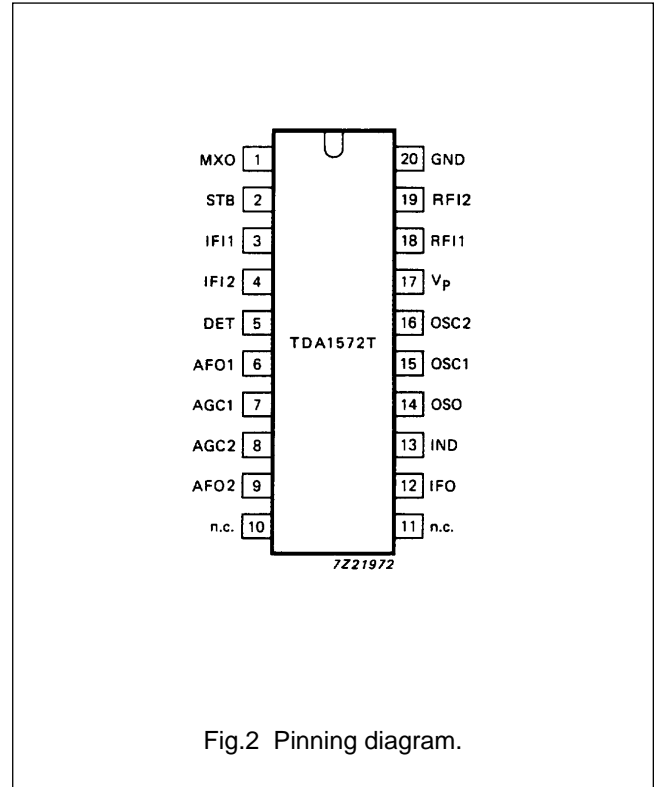

Fig.2 Pinning diagram.

---

**AM receiver****TDA1572T**

---

**FUNCTIONAL DESCRIPTION****Gain-controlled RF stage and mixer**

The differential amplifier in the RF stage employs an AGC negative feedback network to provide a wide dynamic range. Very good cross-modulation behaviour is achieved by AGC delays at the various signal stages. Large signals are handled with low distortion and the  $(S + N)/N$  ratio of small signals is improved. Low noise working is achieved in the differential amplifier by using transistors with low base resistance.

A double balanced mixer provides the IF output signal to pin 1.

**Oscillator**

The differential amplifier oscillator is temperature compensated and is suitable for simple coil connection. The oscillator is voltage-controlled and has little distortion or spurious radiation. It is specially suitable for electronic tuning using variable capacitance diodes. Band switching diodes can easily be applied using the stabilized voltage  $V_{15-20}$ . An extra buffered oscillator output (pin 14) is available for driving a synthesizer. If this is not needed, resistor  $R_{L(14)}$  can be omitted.

**Gain-controlled IF amplifier**

This amplifier comprises two cascaded, variable-gain differential amplifier stages coupled by a band-pass filter. Both stages are gain-controlled by the AGC negative feedback network. The IF output is available at pin 12.

**Detector**

The full-wave, balanced envelope detector has very low distortion over a wide dynamic range. Residual IF carrier is blocked from the signal path by an internal low-pass filter.

**AF preamplifier**

This stage preamplifies the audio frequency output signal. The amplifier output has an emitter follower with a series resistor which, together with an external capacitor, yields the required low-pass for AF filtering.

**AGC amplifier**

The AGC amplifier provides a control voltage which is proportional to the carrier amplitude. Second-order filtering of the AGC voltage achieves signals with very little distortion, even at low audio frequencies. This method of filtering also gives fast AGC settling time which is advantageous for electronic search tuning. The AGC settling time can be further reduced by using capacitors of smaller value in the external filter (C16 and C17). The AGC voltage is fed to the RF and IF stages via suitable AGC delays. The capacitor at pin 7 can be omitted for low-cost applications.

**Field strength indicator output**

A buffered voltage source provides a high-level field strength output signal which has good linearity for logarithmic input signals over the whole dynamic range. If the field strength information is not needed,  $R_{L(13)}$  can be omitted.

**Standby switch**

This switch is primarily intended for AM/FM band switching. During standby mode the oscillator, mixer and AF preamplifier are switched off.

**Short-circuit protection**

All pins have short-circuit protection to ground.

## AM receiver

## TDA1572T

**RATINGS**

Limiting values in accordance with the Absolute Maximum System (IEC 134)

SYMBOL	PARAMETER	MIN.	MAX.	UNIT
$V_P = V_{17-20}$	Supply voltage (pin 17)	–	16	V
$ V_{18-19} $	Input voltage	–	12	V
$-V_{18-19}; -V_{19-20}$		–	0.6	V
$V_{18-19}; V_{19-20}$		–	$V_P$	V
$ I_{18} ;  I_{20} $	Input current (pins 18 and 20)	–	200	mA
$P_{tot}$	Total power dissipation	–	500	mW
$T_{stg}$	Storage temperature range	–55	+150	°C
$T_{amb}$	Operating ambient temperature range	–40	+85	°C
$T_j$	Junction temperature	–	+125	°C
	Electrostatic handling <sup>(1)</sup>			
$V_{es}$	all pins except pins 3, 6, 9, 14	–2000	+2000	V
$V_{es}$	pins 3, 6, 14	–1500	+2000	V
$V_{es}$	pin 9	–1000	+2000	V

**Note**

1. Equivalent to discharging a 100 pF capacitor through a 1.5 kΩ series resistor; (5 pulses, both polarities).

**THERMAL RESISTANCE**

From junction to ambient (in free air)

$$R_{th\ j-a\ (max.)} = 95\ K/W$$

## AM receiver

## TDA1572T

**CHARACTERISTICS**

$V_P = V_{17-20} = 8.5$  V;  $T_{amb} = 25$  °C;  $f_i = 1$  MHz;  $f_m = 400$  Hz;  $m = 30\%$ ;  $f_{IF} = 460$  kHz; measured in test circuit of Fig.1; all voltages referenced to ground; unless otherwise specified.

SYMBOL	PARAMETER	MIN.	TYP.	MAX.	UNIT
	<b>Supply</b>				
$V_P$	Supply voltage (pin 17)	7.5	8.5	14.0	V
$I_P$	Supply current (pin 17)	15	25	28	mA
	<b>RF stage and mixer (pins 18 and 19)</b>				
$V_I$	DC input voltage	–	$V_P/2$	–	V
$Z_i$	RF input impedance at $V_I < 300$ $\mu$ V (rms)	–	5.5	–	k $\Omega$
$C_i$	RF input capacitance	–	25	–	pF
$Z_i$	RF input impedance at $V_I > 10$ mV (rms)	–	8	–	k $\Omega$
$C_i$	RF input capacitance	–	22	–	pF
$Z_o$	IF output impedance (pin 1)	200	–	–	k $\Omega$
$C_o$	IF output capacitance	–	6	–	pF
	Conversion transconductance				
$I_1/V_i$	before start of AGC	–	6.5	–	mA/V
$V_{1-17(p-p)}$	Maximum IF output voltage, inductive coupling to pin 1 (peak-to-peak value)	–	5	–	V
$I_o$	DC value of output current; at $V_I = 0$ V (pin 1)	–	1.2	–	mA
	AGC range of input stage	–	30	–	dB
	RF signal handling capability				
$V_{i(rms)}$	Input voltage (RMS value) for THD = 3% at $m = 80\%$	–	500	–	mV

## AM receiver

## TDA1572T

SYMBOL	PARAMETER	MIN.	TYP.	MAX.	UNIT
	<b>Oscillator</b>				
$f_{osc}$	Frequency range	0.1	–	60	MHz
$V_{(rms)}$	Voltage amplitude (pins 15 to 16) (RMS value)	80	130	150	mV
$R_{(ext)}$	External load impedance (pins 16 to 15)	0.5	–	200	k $\Omega$
$R_{(ext)}$	External load impedance for no oscillation (pins 16 to 15)	–	–	60	$\Omega$
SVRR	Supply voltage ripple rejection at $V_P = 100$ mV(rms); $f_p = 100$ Hz (SVRR = $20 \log [V_{17}/V_{15}]$ )	–	55	–	dB
$V_{15-20}$	Source voltage for switching diodes ( $6 \times V_{BE}$ ) (pin 15)	–	4.2	–	V
$-I_O$	DC output current (for switching diodes) (pin 15)	0	–	20	mA
$\Delta V_I$	Change of output voltage at $\Delta I_{15} = 20$ mA (switch to maximum load) (pin 15)	–	0.3	–	V
	<b>Buffered oscillator output (pin 14)</b>				
$V_O$	DC output voltage	–	0.8	–	V
$V_{O(p-p)}$	Output signal amplitude (peak-to-peak value)	–	320	–	mV
$Z_O$	Output impedance	–	170	–	$\Omega$
$-I_{O(peak)}$	Output current (peak value)	–	–	3	mA
	<b>IF, AGC and AF stages</b>				
$V_I$	DC input voltage (pins 3 and 4)	–	2.0	–	V
$Z_i$	IF input impedance (pins 3 to 4)	2.4	3.0	3.9	k $\Omega$
$C_i$	IF input capacitance	–	7	–	pF
$V_{iIF(rms)}$	IF input voltage for THD = 3% at $m = 80\%$ (pins 3 and 4) (RMS value)	–	90	–	mV
$Z_o$	IF output impedance (pin 12)	–	50	–	$\Omega$
$V_{oIF(rms)}$	Unloaded IF output voltage at $V_i = 10$ mV (pin 12) (RMS value)	180	230	290	mV
$G_v$	Voltage gain before start of AGC (pins 3 to 4; 6 to 20)	–	68	–	dB
$\Delta V_v$	AGC range of IF stages: change of $V_{3-4}$ for 1 dB change of $V_{o(AF)}$ ; $V_{3-4(ref)} = 75$ mV(rms)	–	55	–	dB



## AM receiver

## TDA1572T

SYMBOL	PARAMETER	MIN.	TYP.	MAX.	UNIT
$V_{oAF(rms)}$	AF output voltage (RMS value) at $V_{3-4(IF)} = 50 \mu V(rms)$	–	130	–	mV
$V_{oAF(rms)}$	at $V_{3-4(IF)} = 1 mV(rms)$	–	310	–	mV
$ Z_o $	AF output impedance (pin 6)	2.8	3.5	4.2	k $\Omega$
$ Z_o $	AF output impedance (pin 9)	12.4	15.5	18.6	k $\Omega$
	<b>Indicator driver (pin 13)</b>				
$V_o$	Output voltage at $V_i = 0 mV(rms)$ ; $R_L = 2.7 k\Omega$	–	–	140	mV
$V_o$	Output voltage at $V_i = 500 mV(rms)$ ; $R_L = 2.7 k\Omega$	2.5	2.8	3.1	V
$R_L$	Load resistance	1.5	–	–	k $\Omega$
$-I_o$	Output current at $V_i = 500 mV(rms)$	–	–	2.0	mA
$Z_o$	Output impedance at $-I_o = 0.5 mA$	–	220	–	$\Omega$
$V_o$	Reverse output voltage at AM off	–	6	–	V
	<b>Standby switch</b>				
	Switching threshold at; $V_P = 7.5$ to $14 V$ $T_{amb} = -40$ to $+80 ^\circ C$				
$V_{2-20}$	ON-voltage	0	–	2.0	V
$V_{2-20}$	OFF-voltage	3.5	–	20.0	V
$-I_2$	ON-current at $V_{2-20} = 0 V$	–	100	200	$\mu A$
$ I_2 $	OFF-current at $V_{2-20} = 14 V$	–	–	10	$\mu A$

## AM receiver

## TDA1572T

**OPERATING CHARACTERISTICS**

$V_P = 8.5$  V;  $f_i = 1$  MHz;  $m = 30\%$ ;  $f_m = 400$  Hz;  $T_{amb} = 25$  °C; measured in Fig.1; unless otherwise specified

SYMBOL	PARAMETER	MIN.	TYP.	MAX.	UNIT
	<b>RF sensitivity</b>				
	RF input voltage (RMS value)				
$V_{iRF(rms)}$	for $(S + N)/N = 6$ dB	–	1.5	–	$\mu$ V
$V_{iRF(rms)}$	for $(S + N)/N = 26$ dB	–	15	–	$\mu$ V
$V_{iRF(rms)}$	for $(S + N)/N = 46$ dB	–	150	–	$\mu$ V
$V_{iRF(rms)}$	at start of AGC	–	30	–	$\mu$ V
	<b>RF large signal handling</b>				
	RF input voltage (RMS value)				
$V_{iRF(rms)}$	at THD = 3%; $m = 80\%$	–	500	–	mV
$V_{iRF(rms)}$	at THD = 3%; $m = 30\%$	–	700	–	mV
$V_{iRF(rms)}$	at THD = 10%; $m = 30\%$	–	900	–	mV
	<b>AGC range</b>				
	Change of $V_i$ for 1 dB change of $V_{oAF}$ ; $V_{i(ref)} = 500$ mV(rms)	–	86	–	dB
$\Delta V_i$	Change of $V_i$ for 6 dB change of $V_{oAF}$ ; $V_{i(ref)} = 500$ mV(rms)	–	91	–	dB
	<b>Output signal</b> (RMS value)				
$V_{oIF(rms)}$	IF output voltage at $V_i = 2$ mV(rms)	180	230	290	mV
	AF output voltage				
$V_{oAF(rms)}$	at $V_i = 4$ $\mu$ V(rms); $m = 80\%$	–	130	–	mV
$V_{oAF(rms)}$	at $V_i = 2$ mV(rms)	240	310	390	mV
	Total harmonic distortion				
THD	at $V_i = 2$ mV(rms); $m = 30\%$	–	0.5	–	%
THD	at $V_i = 2$ mV(rms); $m = 80\%$	–	1.0	–	%
THD	at $V_i = 500$ mV(rms); $m = 30\%$	–	1.0	–	%
$(S + N)/N$	Signal-to-noise ratio at $V_i = 100$ mV(rms)	–	58	–	dB
	Supply voltage ripple rejection at $V_i = 2$ mV(rms) $V_P = 100$ mV(rms); $f_p = 100$ Hz				
SVRR	( $SVRR = 20 \log [V_P/V_{oAF}]$ )	–	38	–	dB
SVRR	(a) additional AF signal at IF output	–	0 <sup>(1)</sup>	–	dB
SVRR	(b) add modulation at IF output ( $m_{ref} = 30\%$ )	–	40	–	dB

AM receiver

TDA1572T

SYMBOL	PARAMETER	MIN.	TYP.	MAX.	UNIT
	<b>Unwanted signals</b>				
	Suppression of IF whistles at $V_i = 15 \mu\text{V}$ ; $m = 0\%$ related to AF signal of $m = 30\%$				
$\alpha_{2IF}$	at $f_i \approx 2 \times f_{IF}$	-	37	-	dB
$\alpha_{3IF}$	at $f_i \approx 3 \times f_{IF}$	-	44	-	dB
	IF suppression at RF input;				
$\alpha_{IF}$	for symmetrical input	-	40	-	dB
$\alpha_{IF}$	for asymmetrical input	-	40	-	dB
	Residual oscillator signal at mixer output;				
$I_{1(osc)}$	at $f_{osc}$	-	1	-	$\mu\text{A}$
$I_{1(2osc)}$	at $2 \times f_{osc}$	-	1.1	-	$\mu\text{A}$

Note

- AF signals at the IF output will be suppressed by a coupling capacitor to the demodulator and by full wave-detection in the demodulator.

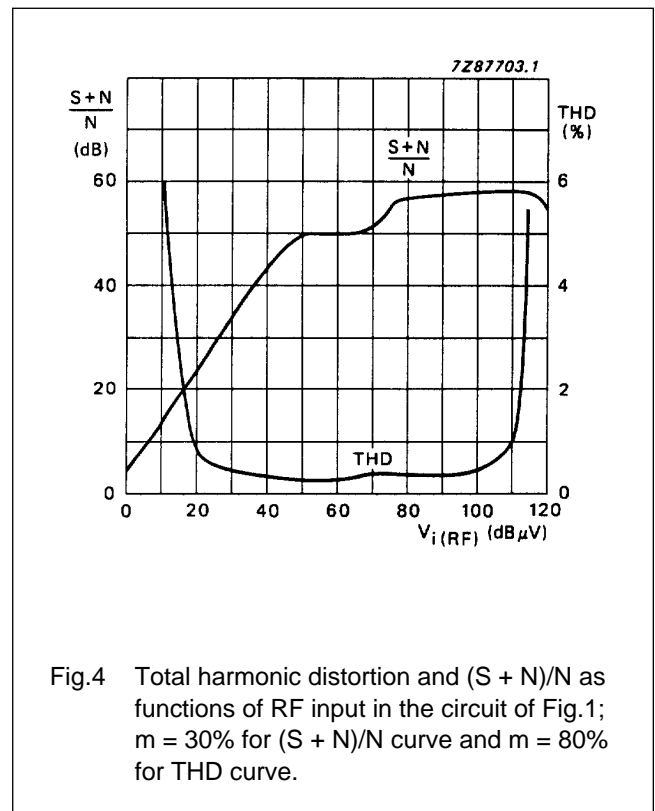
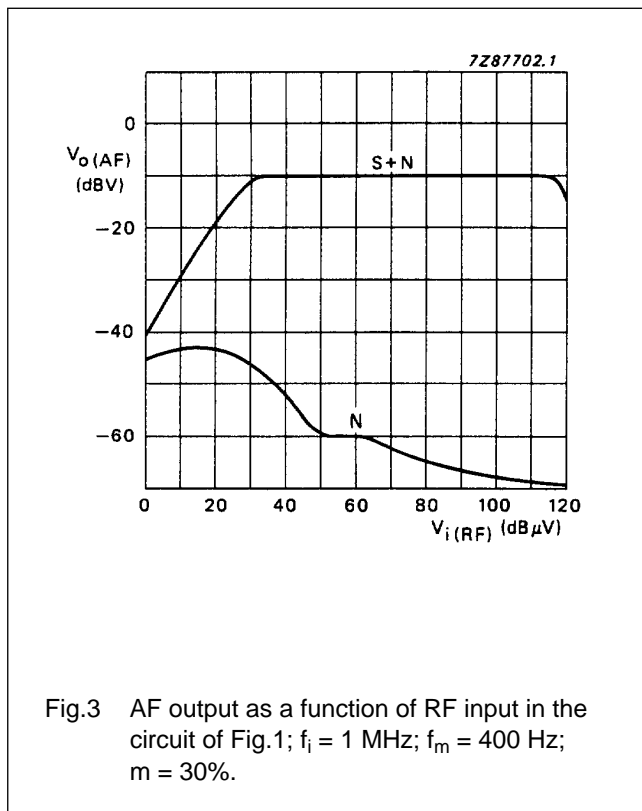

AM receiver

TDA1572T

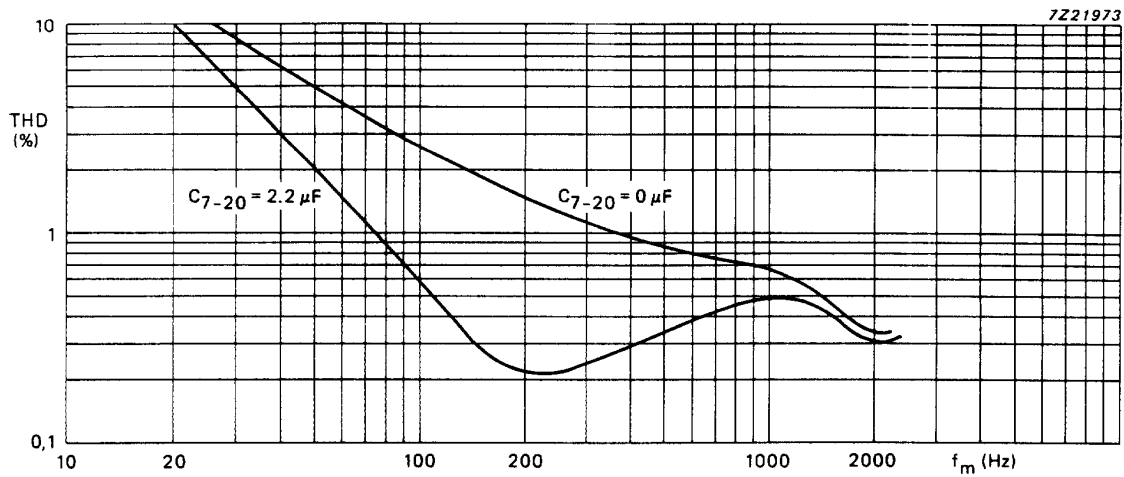

Fig.5 Total harmonic distortion as a function of modulation frequency at  $V_i = 5 \text{ mV}$ ;  $m = 80\%$ ; measured in the circuit of Fig.1 with  $C_{7-20(\text{ext})} = 0 \mu\text{F}$  and  $2.2 \mu\text{F}$ .

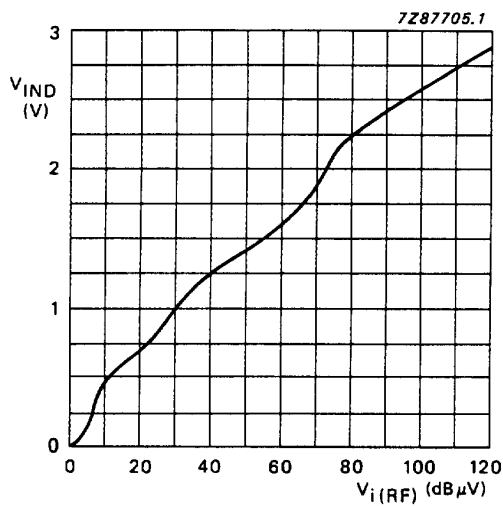
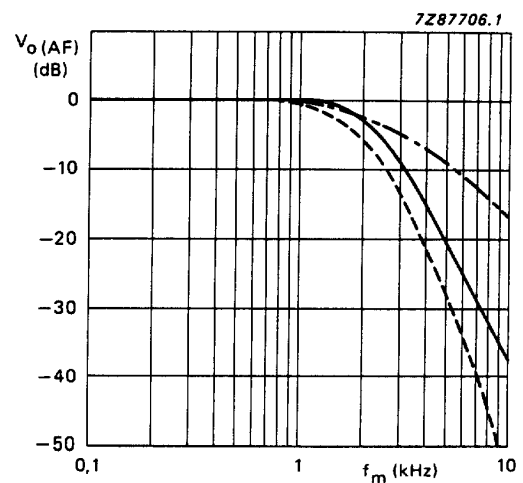

Fig.6 Indicator driver voltage as a function of RF input in the circuit of Fig.1.



- with IF filter;
- - - with AF filter;
- · - · with IF and AF filters.

Fig.7 Typical frequency response curves from Fig.1 showing the effect of filtering.

AM receiver

TDA1572T

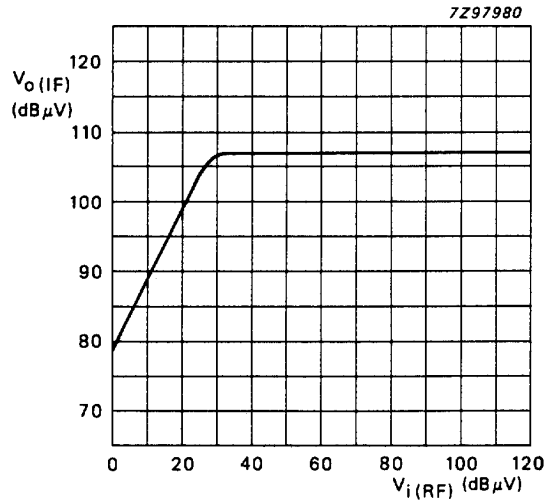

Fig.8 IF output voltage as a function of RF input in the circuit of Fig.1;  $f_i = 1$  MHz.

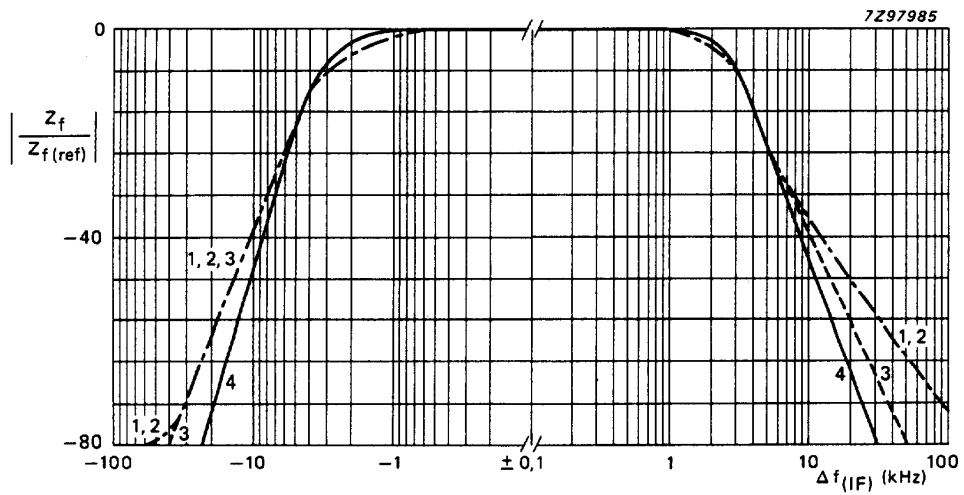

Fig.9 Forward transfer impedance as a function of intermediate frequency for filters 1 to 4 shown in Fig.10; centre frequency = 455 kHz.

AM receiver

TDA1572T

APPLICATION INFORMATION

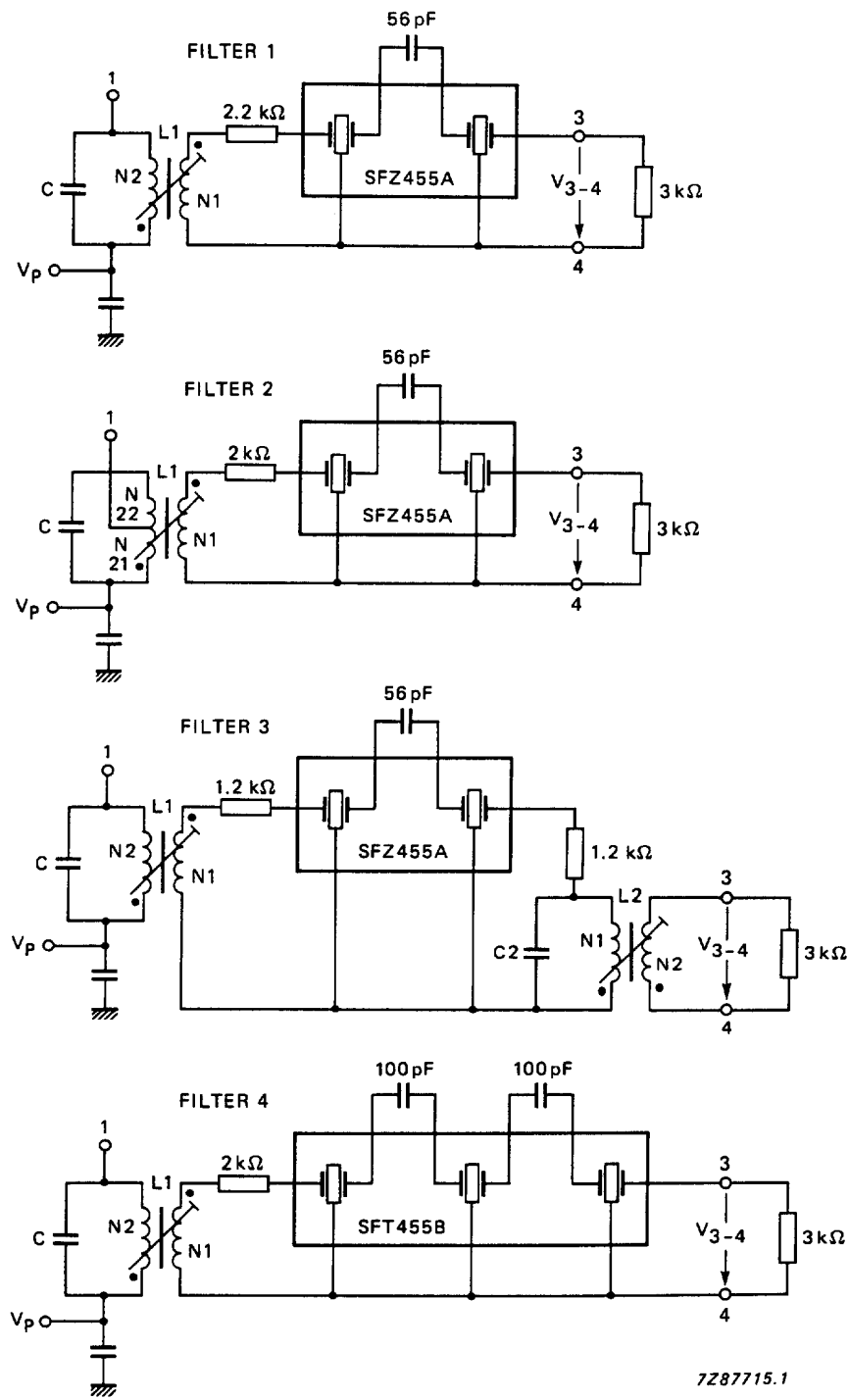

Fig.10 IF filter variants applied to the circuit of Fig.1. For filter data, refer to Table 1.

AM receiver

TDA1572T

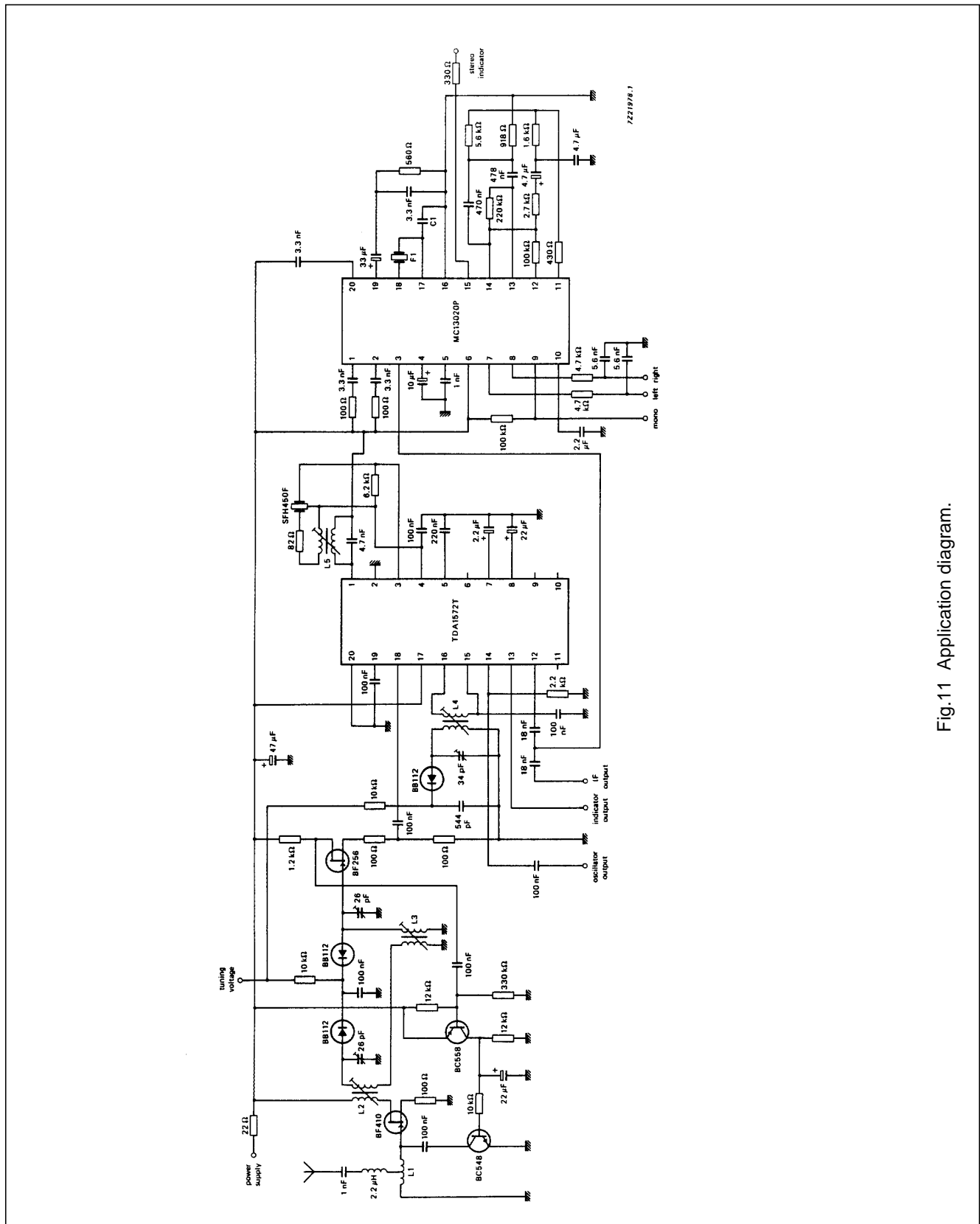

Fig.11 Application diagram.

AM receiver

TDA1572T

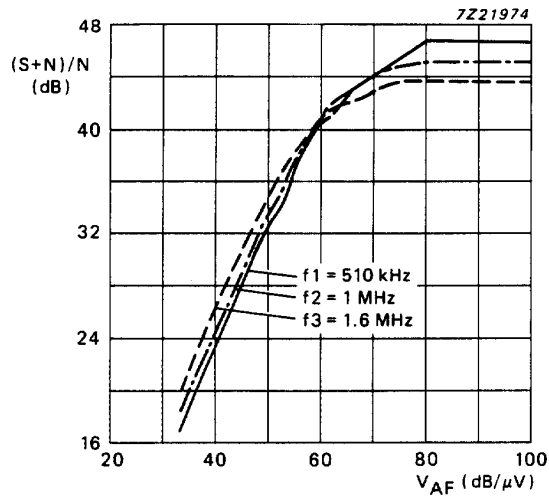

Fig.12 (S + N)/N as a function of input voltage; measured in the circuit of Fig.11 for AM stereo.

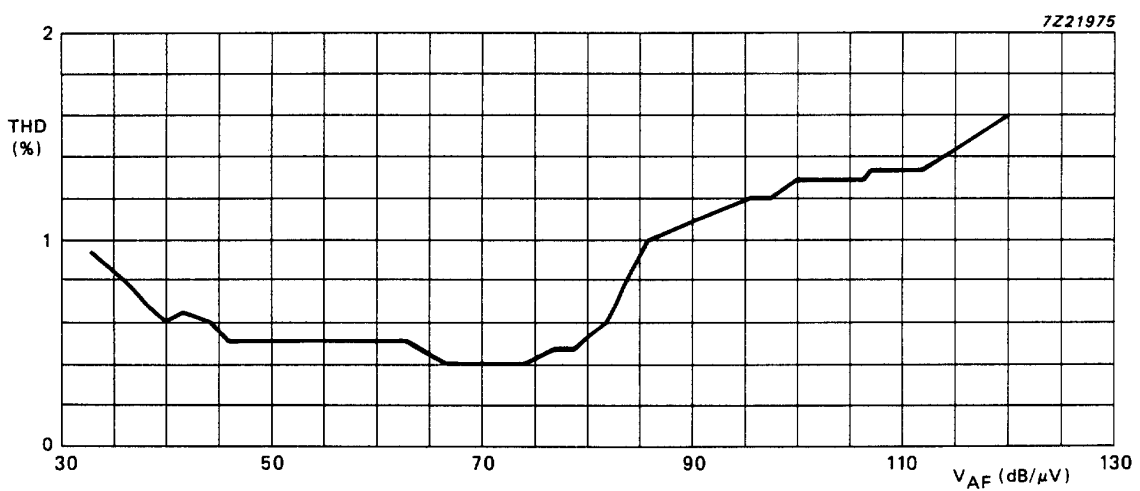

Fig.13 Total harmonic distortion (THD) as a function of input voltage; measured in the circuit of Fig.11 for AM stereo.



AM receiver

TDA1572T

**Table 1** Data for IF filters shown in Fig.10 (Filter 1 to 4) and Fig.11 (Filter 5). Criteria for adjustment is IF = maximum (optimum selectivity curve at centre frequency  $f_0 = 455$  kHz). Filter 5 is used for AM stereo application with centre frequency  $f_0 = 450$  kHz.

FILTER NO.	1	2	3	4	5	UNIT
<b>Coil data</b>	L1	L1	L1 L2	L1	L1	
Value of C	3900	430	4700	3900	4700	pF
N1 : N2	12 : 32	13 : (33 + 66)	29 : 29	13 : 31	26 : 32	
Diameter of CU laminated wire	0.09	0.08	0.08	0.09	0.07	mm
Q <sub>o</sub>	65 (typ.)	50	60	75	50	
Schematic* of windings						
Toko order no.	7XNS-A7523DY	L7PES-A0060BTG	(N1) (N2) 7XNS-A7518DY 7XNS-A7521AIH	7XNS-A7519DY		
<b>Resonators</b>						
Murata type	SFZ455A	SFZ455A	SFZ455A	SFT455B	SFH450F	
D (typical value)	4	4	4	6	6	dB
R <sub>G</sub> , R <sub>L</sub>	3	3	3	3	2	kΩ
Bandwidth (-3 dB)	4.2	4.2	4.2	4.5	10	kHz
S <sub>9kHz</sub>	24	24	24	38		dB
<b>Filter data</b>						
Z <sub>I</sub>	4.8	3.8	4.2	4.8	1.8	kΩ
Q <sub>B</sub>	57	40	52 (L1) 18 (L2)	55	20	
Z <sub>F</sub>	0.70	0.67	0.68	0.68	0.70	kΩ
Bandwidth (-3 dB)	3.6	3.8	3.6	4.0	10	kHz
S <sub>9kHz</sub>	35	31	36	42		dB
S <sub>18kHz</sub>	52	49	54	64		dB
S <sub>27kHz</sub>	63	58	66	74		dB

\* The beginning of an arrow indicates the beginning of a winding; N1 is always the inner winding, N2 the outer winding.

AM receiver

TDA1572T

PACKAGE OUTLINE

SO20: plastic small outline package; 20 leads; body width 7.5 mm

SOT163-1

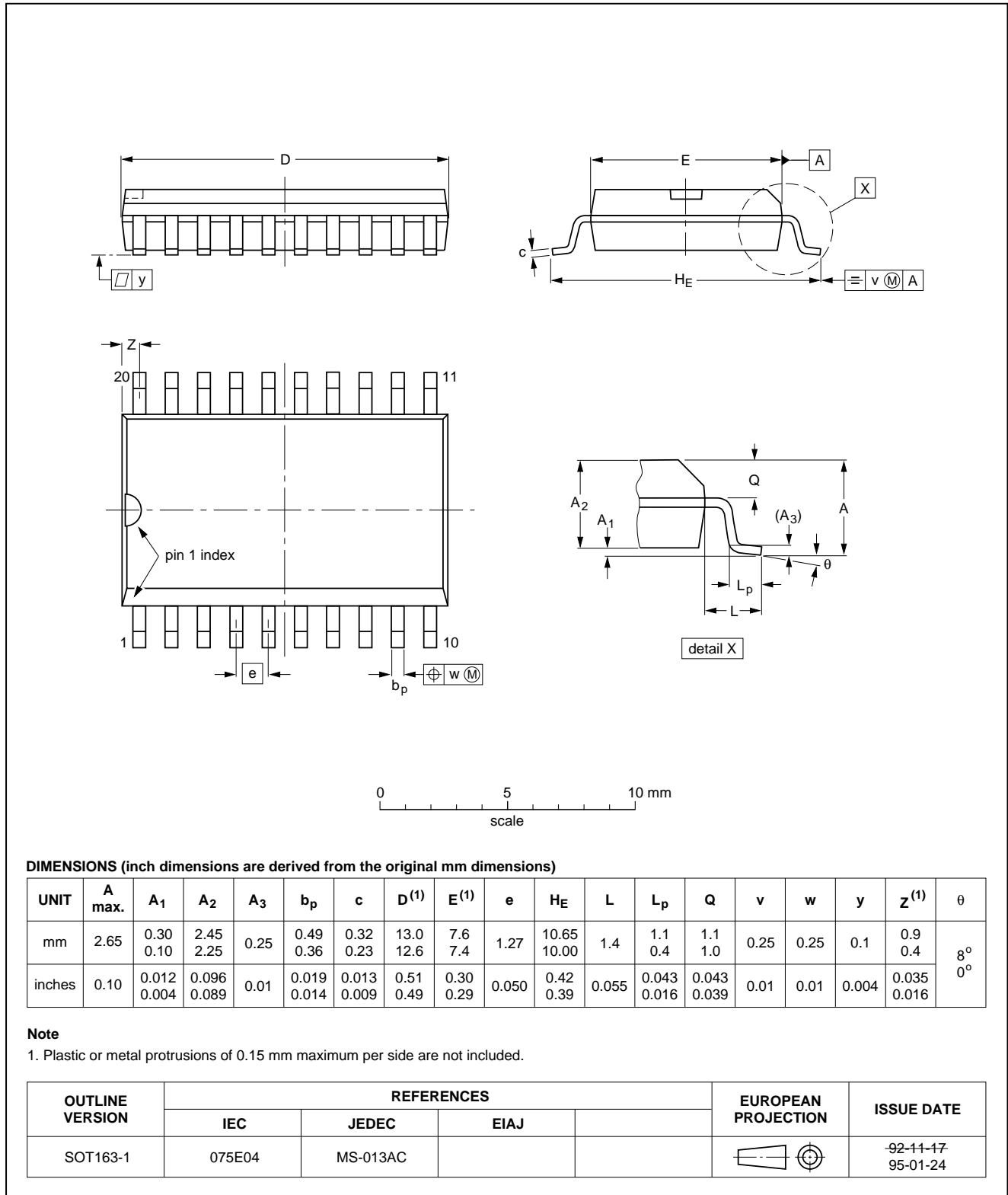

---

## AM receiver

## TDA1572T

---

### SOLDERING

#### Introduction

There is no soldering method that is ideal for all IC packages. Wave soldering is often preferred when through-hole and surface mounted components are mixed on one printed-circuit board. However, wave soldering is not always suitable for surface mounted ICs, or for printed-circuits with high population densities. In these situations reflow soldering is often used.

This text gives a very brief insight to a complex technology. A more in-depth account of soldering ICs can be found in our "*IC Package Databook*" (order code 9398 652 90011).

#### Reflow soldering

Reflow soldering techniques are suitable for all SO packages.

Reflow soldering requires solder paste (a suspension of fine solder particles, flux and binding agent) to be applied to the printed-circuit board by screen printing, stencilling or pressure-syringe dispensing before package placement.

Several techniques exist for reflowing; for example, thermal conduction by heated belt. Dwell times vary between 50 and 300 seconds depending on heating method. Typical reflow temperatures range from 215 to 250 °C.

Preheating is necessary to dry the paste and evaporate the binding agent. Preheating duration: 45 minutes at 45 °C.

#### Wave soldering

Wave soldering techniques can be used for all SO packages if the following conditions are observed:

- A double-wave (a turbulent wave with high upward pressure followed by a smooth laminar wave) soldering technique should be used.
- The longitudinal axis of the package footprint must be parallel to the solder flow.
- The package footprint must incorporate solder thieves at the downstream end.

During placement and before soldering, the package must be fixed with a droplet of adhesive. The adhesive can be applied by screen printing, pin transfer or syringe dispensing. The package can be soldered after the adhesive is cured.

Maximum permissible solder temperature is 260 °C, and maximum duration of package immersion in solder is 10 seconds, if cooled to less than 150 °C within 6 seconds. Typical dwell time is 4 seconds at 250 °C.

A mildly-activated flux will eliminate the need for removal of corrosive residues in most applications.

#### Repairing soldered joints

Fix the component by first soldering two diagonally-opposite end leads. Use only a low voltage soldering iron (less than 24 V) applied to the flat part of the lead. Contact time must be limited to 10 seconds at up to 300 °C. When using a dedicated tool, all other leads can be soldered in one operation within 2 to 5 seconds between 270 and 320 °C.

## AM receiver

## TDA1572T

**DEFINITIONS**

<b>Data sheet status</b>	
Objective specification	This data sheet contains target or goal specifications for product development.
Preliminary specification	This data sheet contains preliminary data; supplementary data may be published later.
Product specification	This data sheet contains final product specifications.
<b>Limiting values</b>	
Limiting values given are in accordance with the Absolute Maximum Rating System (IEC 134). Stress above one or more of the limiting values may cause permanent damage to the device. These are stress ratings only and operation of the device at these or at any other conditions above those given in the Characteristics sections of the specification is not implied. Exposure to limiting values for extended periods may affect device reliability.	
<b>Application information</b>	
Where application information is given, it is advisory and does not form part of the specification.	

**LIFE SUPPORT APPLICATIONS**

These products are not designed for use in life support appliances, devices, or systems where malfunction of these products can reasonably be expected to result in personal injury. Philips customers using or selling these products for use in such applications do so at their own risk and agree to fully indemnify Philips for any damages resulting from such improper use or sale.