

# DATA SHEET

## **BLT53** UHF power transistor

Product specification

May 1991

# UHF power transistor

# BLT53

### FEATURES

- Emitter-ballasting resistors for an optimum temperature profile
- Gold metallization ensures excellent reliability
- Withstands full load mismatch.

### DESCRIPTION

NPN silicon planar epitaxial transistor encapsulated in a 4-lead SOT122D studless envelope with a ceramic cap. It is designed for common emitter, class-B operation in portable radio transmitters in the 470 MHz communications band. All leads are isolated from the mounting flange.

### PINNING - SOT122D

PIN	DESCRIPTION
1	collector
2	emitter
3	base
4	emitter

### QUICK REFERENCE DATA

RF performance at  $T_{mb} = 25\text{ }^{\circ}\text{C}$  in a common emitter test circuit.

MODE OF OPERATION	f (MHz)	$V_{CE}$ (V)	$P_L$ (W)	$G_p$ (dB)	$\eta_c$ (%)
c.w. class-B	470	7.5	8	> 6	> 60

WARNING
<b>Product and environmental safety - toxic materials</b>
This product contains beryllium oxide. The product is entirely safe provided that the BeO disc is not damaged. All persons who handle, use or dispose of this product should be aware of its nature and of the necessary safety precautions. After use, dispose of as chemical or special waste according to the regulations applying at the location of the user. It must never be thrown out with the general or domestic waste.

### PIN CONFIGURATION

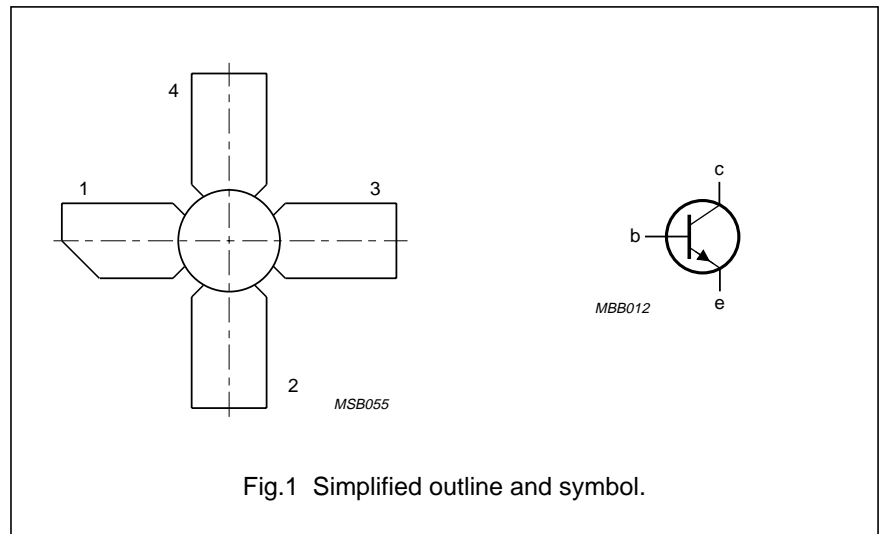

# UHF power transistor

# BLT53

## LIMITING VALUES

In accordance with the Absolute Maximum System (IEC 134).

SYMBOL	PARAMETER	CONDITIONS	MIN.	MAX.	UNIT
$V_{CBO}$	collector-base voltage	open emitter	–	20	V
$V_{CEO}$	collector-emitter voltage	open base	–	10	V
$V_{EBO}$	emitter-base voltage	open collector	–	3	V
$I_C, I_{C(AV)}$	collector current	DC or average value	–	2.5	A
$I_{CM}$	collector current	peak value $f > 1$ MHz	–	7.5	A
$P_{tot}$	total power dissipation	RF operation; $T_{mb} = 25$ °C	–	35.5	W
$T_{stg}$	storage temperature range		–65	150	°C
$T_j$	junction operating temperature		–	200	°C

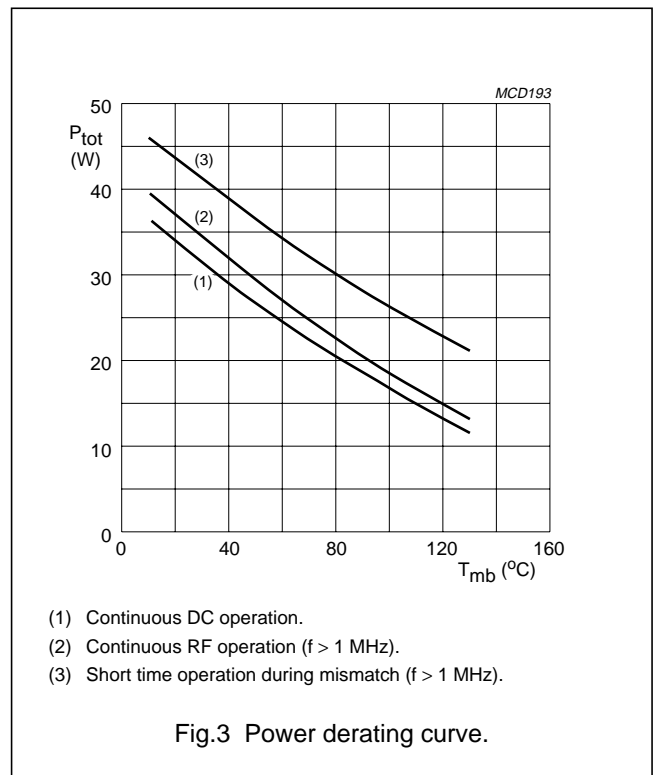
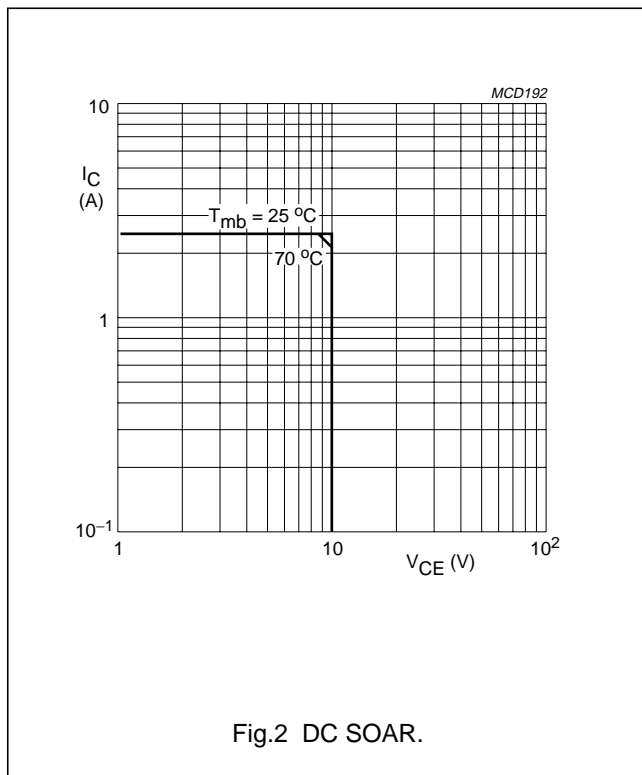

## THERMAL RESISTANCE

SYMBOL	PARAMETER	CONDITIONS	MAX.	UNIT
$R_{th\ j-mb(RF)}$	from junction to mounting base	$P_{tot} = 35.5$ W; $T_{mb} = 25$ °C	4.9	K/W

UHF power transistor

BLT53

CHARACTERISTICS

$T_j = 25\text{ }^\circ\text{C}$ .

SYMBOL	PARAMETER	CONDITIONS	MIN.	TYP.	MAX.	UNIT
$V_{(BR)CBO}$	collector-base breakdown voltage	open emitter; $I_C = 20\text{ mA}$	20	–	–	V
$V_{(BR)CEO}$	collector-emitter breakdown voltage	open base; $I_C = 40\text{ mA}$	10	–	–	V
$V_{(BR)EBO}$	emitter-base breakdown voltage	open collector; $I_E = 4\text{ mA}$	3	–	–	V
$I_{CES}$	collector-emitter leakage current	$V_{BE} = 0$ ; $V_{CE} = 10\text{ V}$	–	–	1	mA
$h_{FE}$	DC current gain	$V_{CE} = 5\text{ V}$ ; $I_C = 1.2\text{ A}$	25	–	–	
$f_T$	transition frequency	$V_{CE} = 7.5\text{ V}$ ; $I_E = 1.6\text{ A}$	–	3.9	–	GHz
$C_c$	collector capacitance	$V_{CB} = 7.5\text{ V}$ ; $I_E = I_e = 0$ ; $f = 1\text{ MHz}$	–	24	–	pF
$C_{re}$	feedback capacitance	$V_{CE} = 7.5\text{ V}$ ; $I_C = 0$ ; $f = 1\text{ MHz}$	–	17	–	pF
$C_{c-mb}$	collector-mounting base capacitance	$f = 1\text{ MHz}$	–	1.2	–	pF

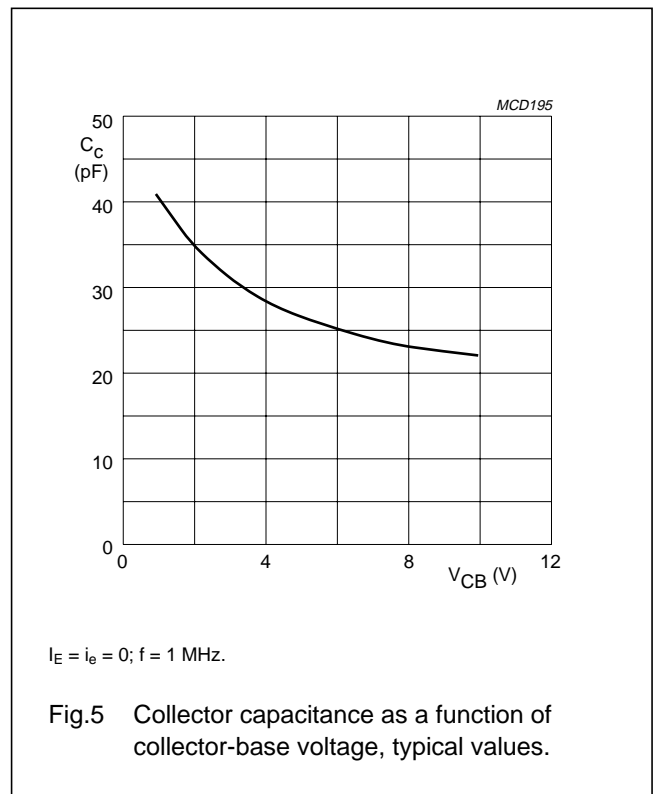
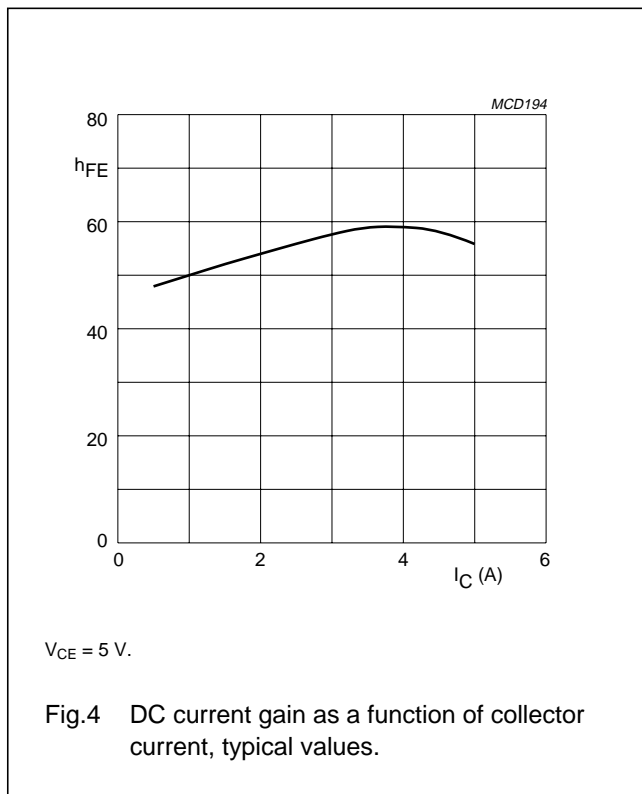

UHF power transistor

BLT53

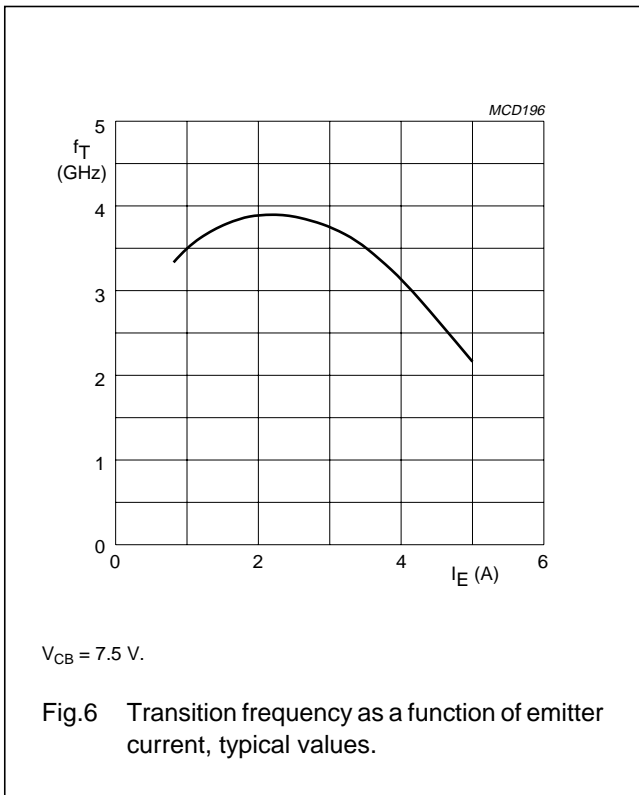

UHF power transistor

BLT53

**APPLICATION INFORMATION**

RF performance at  $T_{mb} = 25\text{ }^{\circ}\text{C}$  in a common emitter test circuit.

MODE OF OPERATION	f (MHz)	V <sub>CE</sub> (V)	P <sub>L</sub> (W)	G <sub>p</sub> (dB)	η <sub>c</sub> (%)
c.w. class-B	470	7.5	8	> 6 typ. 6.8	> 60 typ. 65

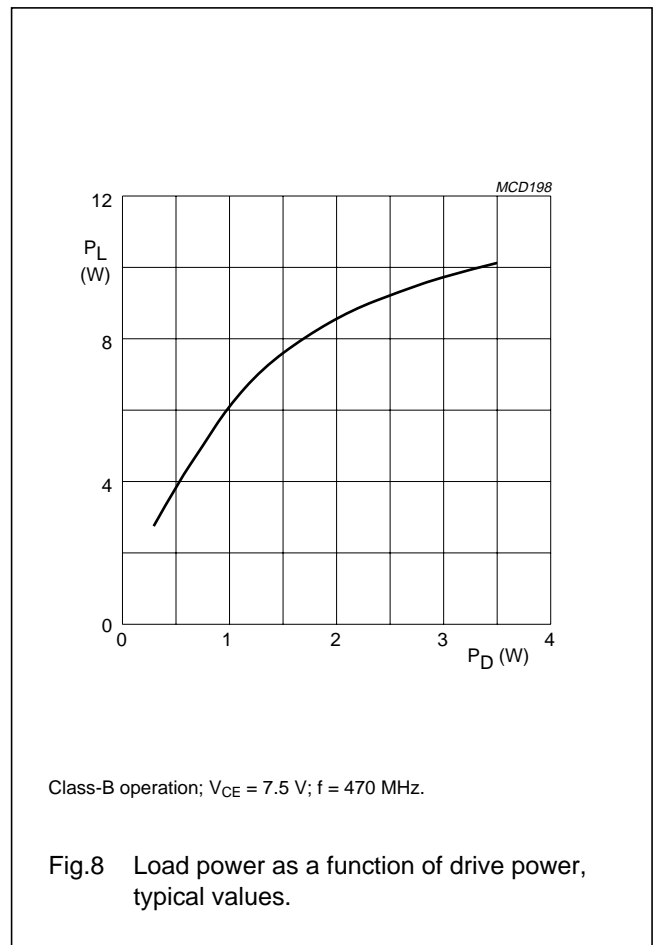
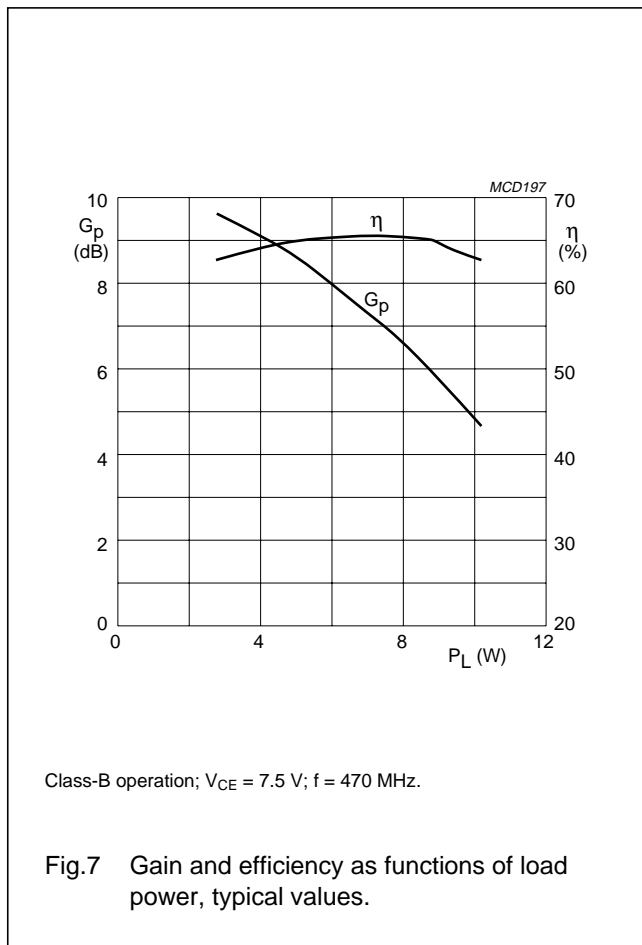

**Ruggedness in class-B operation**

The BLT53 is capable of withstanding a full load mismatch corresponding to  $V_{SWR} = 50:1$  through all phases at rated output power, up to a supply voltage of 9 V, and  $f = 470\text{ MHz}$ .

## UHF power transistor

## BLT53

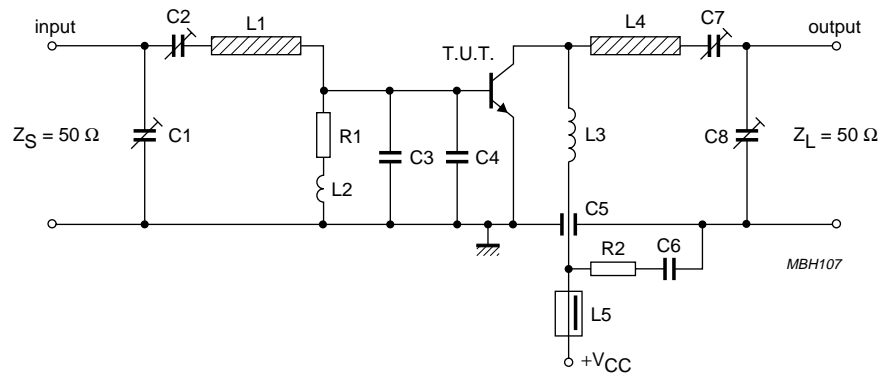
Fig.9 Class-B test circuit at  $f = 470$  MHz.

## List of components (see test circuit)

COMPONENT	DESCRIPTION	VALUE	DIMENSIONS	CATALOGUE NO.
C1, C2, C7, C8	film dielectric trimmer	2 to 9 pF		2222 809 09002
C3, C4	multilayer ceramic chip capacitor	15 pF		
C5	feed-through capacitor	100 pF		
C6	polyester capacitor	33 nF		
L1	stripline (note 1)	44 Ω	41.1 mm × 5 mm	
L2	13 turns closely wound enamelled 0.5 mm copper wire	320 nH	int. dia. 4 mm	
L3	2 turns enamelled 1 mm copper wire		int. dia. 4 mm; pitch 1.5 mm; leads 2 × 5 mm	
L4	stripline (note 1)	44 Ω	52.7 mm × 5 mm	
L5	grade 3B1 Ferroxcube wideband HF choke			4312 020 36640
R1	0.25 W carbon resistor	1 Ω, 5%		
R2	0.25 W carbon resistor	10 Ω, 5%		

## Note

- The striplines are mounted on a double copper-clad printed circuit board, with PTFE fibre-glass dielectric ( $\epsilon_r = 2.74$ ); thickness  $\frac{1}{16}$  inch.

UHF power transistor

BLT53

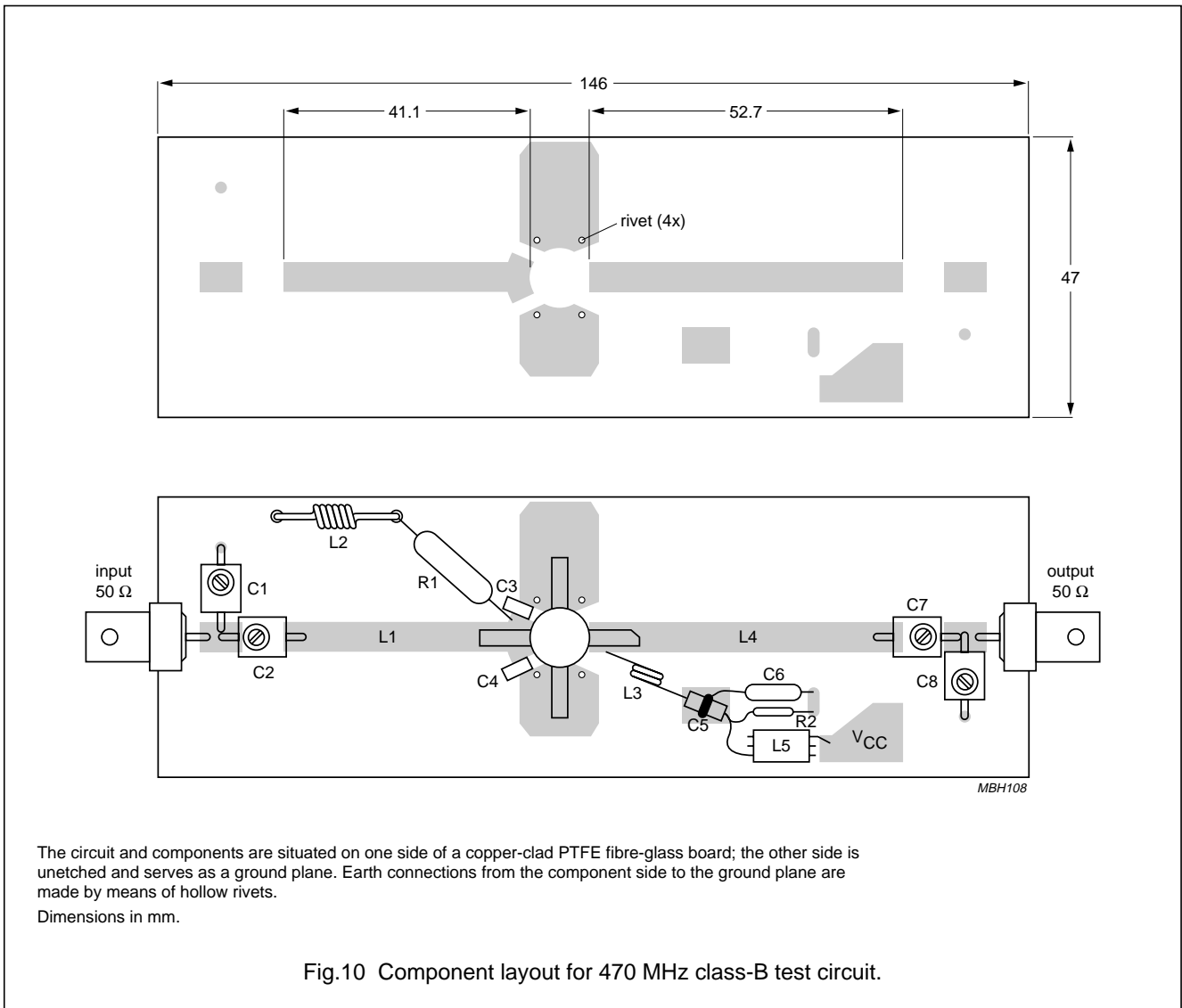



UHF power transistor

BLT53

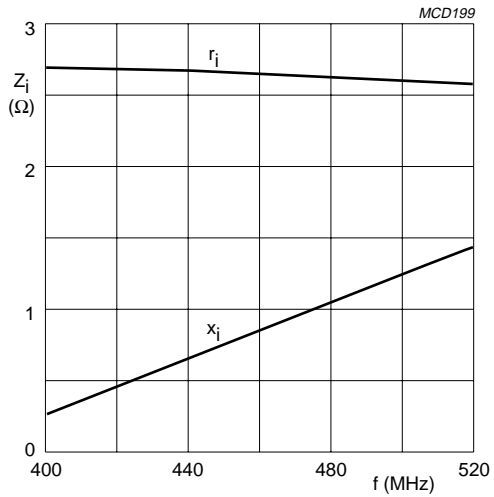

Class-B operation;  $V_{CE} = 7.5$  V;  $P_L = 8$  W.

Fig. 11 Input impedance (series components) as a function of frequency, typical values.

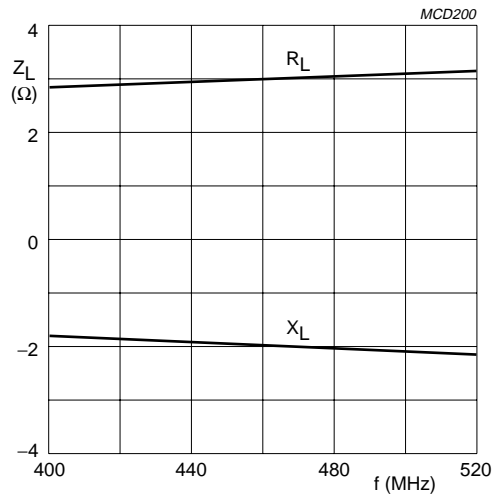

Class-B operation;  $V_{CE} = 7.5$  V;  $P_L = 8$  W.

Fig. 12 Load impedance (series components) as a function of frequency, typical values.

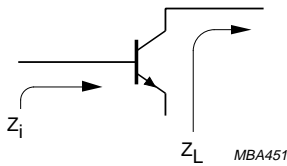
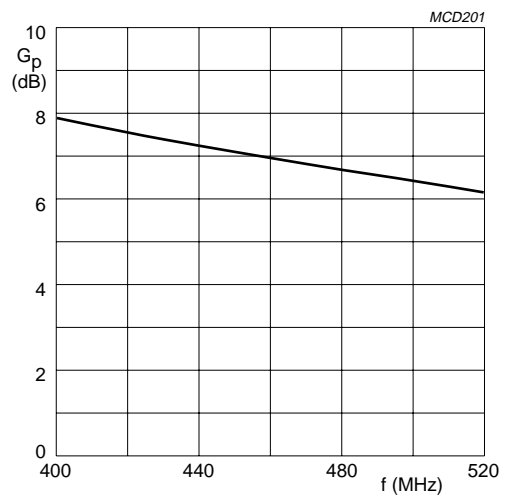

Fig. 13 Definition of transistor impedance.



Class-B operation;  $V_{CE} = 7.5$  V;  $P_L = 8$  W.

Fig. 14 Power gain as a function of frequency, typical values.

UHF power transistor

BLT53

PACKAGE OUTLINE

Studless ceramic package; 4 leads

SOT122D

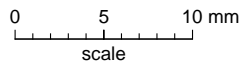
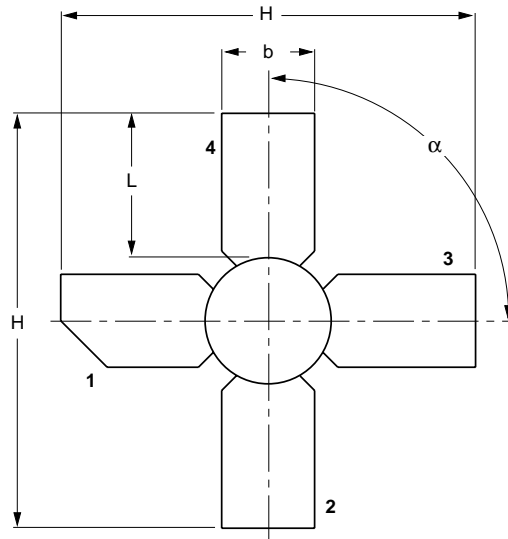
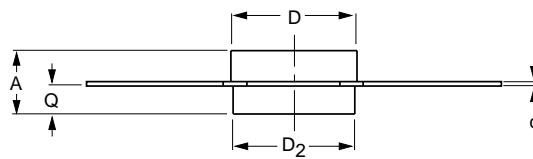

DIMENSIONS (millimetre dimensions are derived from the original inch dimensions)

UNIT	A	b	c	D	D <sub>2</sub>	H	L	Q	α
mm	4.17 3.27	5.85 5.58	0.18 0.14	7.50 7.23	7.24 6.98	27.56 25.78	9.91 9.14	1.58 1.27	90°

OUTLINE VERSION	REFERENCES			EUROPEAN PROJECTION	ISSUE DATE
	IEC	JEDEC	EIAJ		
SOT122D					97-04-18

## UHF power transistor

BLT53

**DEFINITIONS**

<b>Data Sheet Status</b>	
Objective specification	This data sheet contains target or goal specifications for product development.
Preliminary specification	This data sheet contains preliminary data; supplementary data may be published later.
Product specification	This data sheet contains final product specifications.
<b>Limiting values</b>	
Limiting values given are in accordance with the Absolute Maximum Rating System (IEC 134). Stress above one or more of the limiting values may cause permanent damage to the device. These are stress ratings only and operation of the device at these or at any other conditions above those given in the Characteristics sections of the specification is not implied. Exposure to limiting values for extended periods may affect device reliability.	
<b>Application information</b>	
Where application information is given, it is advisory and does not form part of the specification.	

**LIFE SUPPORT APPLICATIONS**

These products are not designed for use in life support appliances, devices, or systems where malfunction of these products can reasonably be expected to result in personal injury. Philips customers using or selling these products for use in such applications do so at their own risk and agree to fully indemnify Philips for any damages resulting from such improper use or sale.