

FEATURES

Conventional LED design : Simple to use

High Flux and Low Cost : More competitive advantages in the LED industry

Special body frame : Excellent transiting heat from LED chip operating under 150mA.

ADVANTAGES

Operating Current : 150mA .

Custom Design Light Sourcing Module for 0.4W

Excellent Heat Dissipation.

TYPICAL APPLICATIONS

Reading Light / Flashlight / Track Lighting

Under Shelf / Task Lighting

Emergency Lighting / Traffic Signals

Bollards / Security / Garden Lighting

Full Color Sign Boards



ABSOLUTE MAXIMUM RATINGS Tj=25°C

Parameter	EP204K-150R1	Units
DC Forward Current	150	mA
Pulsed Forward Current	500	mA
Power Dissipation	400	mW
Dark Current (VR=5V)	100	uA
Operating Temperature Range	-20 to 80	°C
Storage Temperature Range	-35 to 85	°C
Soldering Temperature	245	°C
Thermal Resistance R θ (°C/W)	85	°C/W
LED Junction Temperature	110	°C

Operating conditions:

1.Amber operating condition under f=0.5 ~ 2 Hz and 1/2 duty factor .

2. 520mw(White) : 6 pins of E-Power LED required soldering on PCB.

(PCB : 24.5 mm *24.5 mm , 1.6 t / two layers / 2.0 oz .)

3.Convective IR Reflow SolderingConvective IR Reflow Soldering.

ELECTRICAL CHARACTERISTICS

Tj=25°C IF=150mA

Device Type	Forward Voltage VF (Volts)			Dark Current VR=5V IR=(uA)		Intensity Iv (cd)		Total Flux Φv (lm)	Wavelength λD (nm)	Viewing Angle 2θ 1/2 (Degrees)
	Min.	Typ.	Max.	Typ.	Max.	Min.	Typ.	Typ	Typ.	Typ.
EP204K-150R1	2.0	2.4	2.8	10	100	2.4	4	3	620	100°

This specification is subject to change without notice.

OUTLINE DRAWINGS

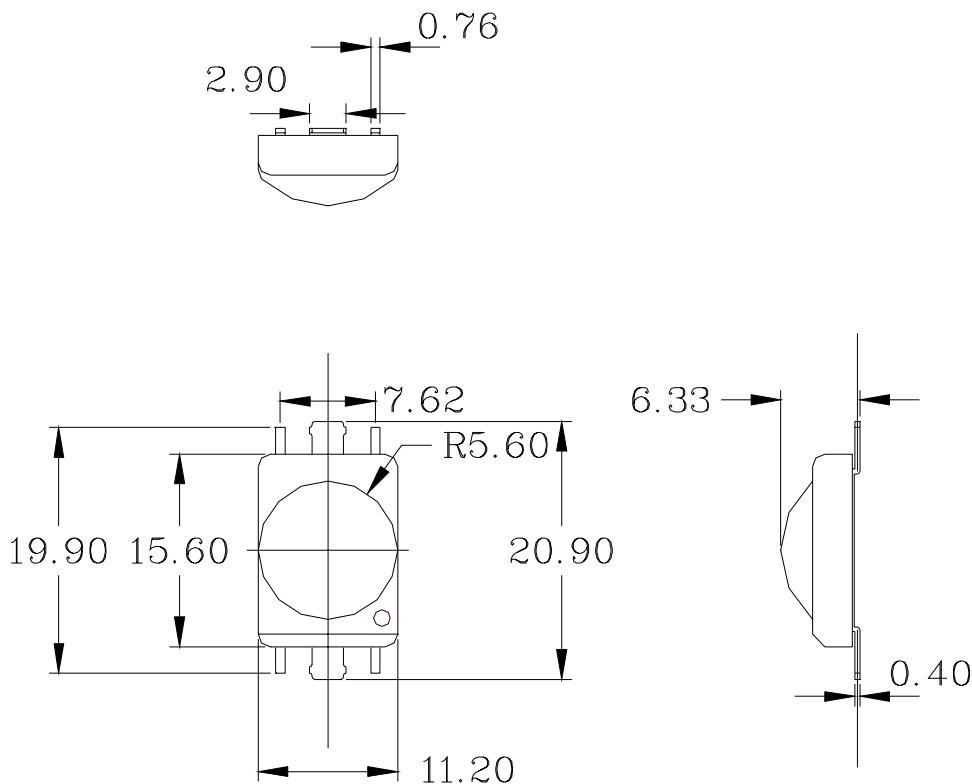

NOTE

1. All dimensions are in millimeters.
2. Tolerance is 0.25mm unless otherwise specified.
3. This specification is subject to change without notice.

CHARACTERISTICS CURVE

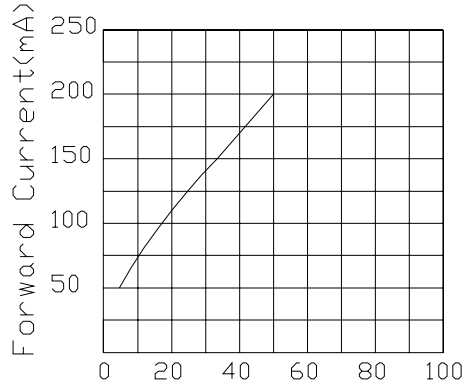

Junction Temperature (°C)
RED

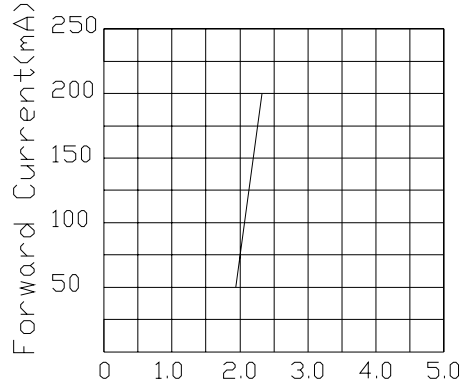

Forward Voltage (V)
RED

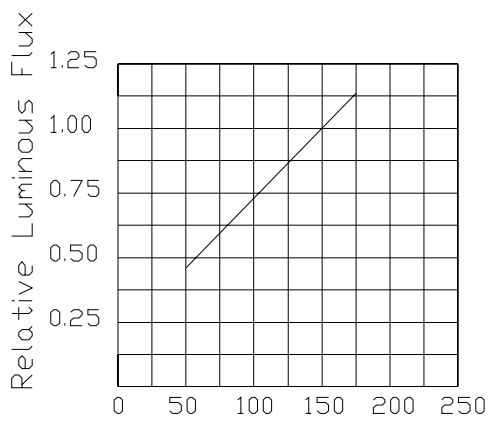

Forward Current (mA)
RED

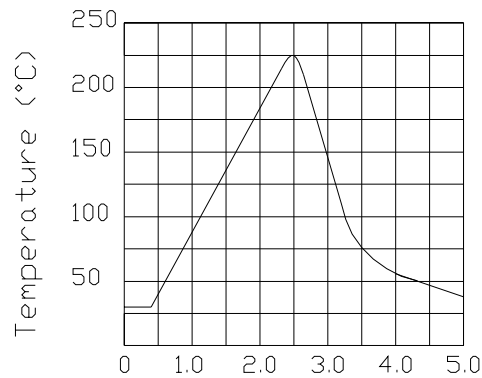

TIME (min)
Soldering Temperature

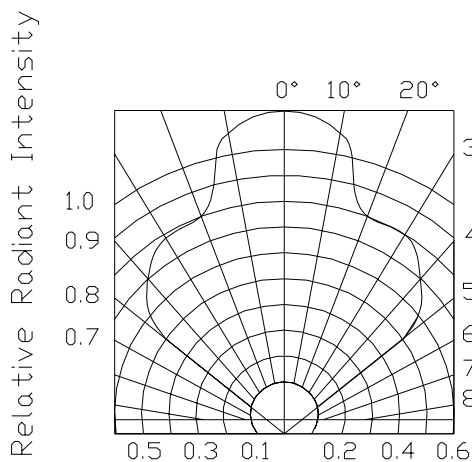

VIEW ANGLE
EP204K-150XX

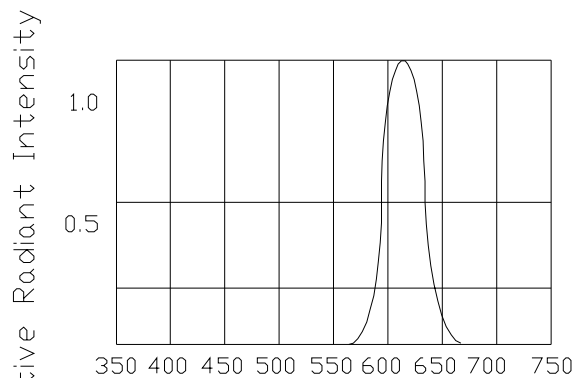

Wavelength (nm)
Spectral Distribution
RED

Operation Life

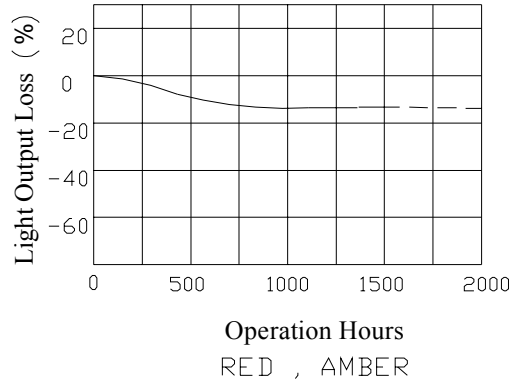

PIN CONNECTION

COLOR	R	G	B	C	A
ANODE	6	6	6	6	6
CATHODE	2	3	3	3	2
	5				5

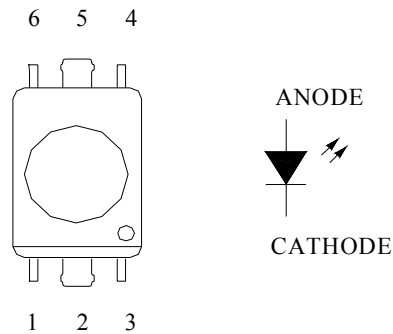

TEST CIRCUIT

COLOR	Vf(min)	R(100mA)	R(150mA)
R	2.0V	30 Ω	20 Ω

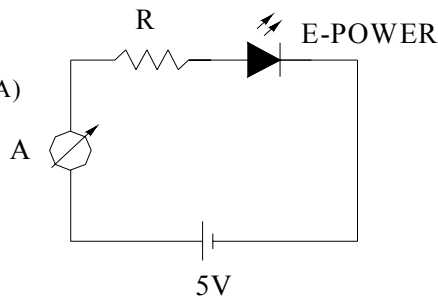

PART NO. SYSTEM OF E-Power LED

EP 2 04 K-150 R1

1---2-3-4-5-----6-----7

1.E -Power LED

2.YEAR 2002

3.PACKAGE TYPE:01=10mm LENS;03=5mm LENS;04=11 mm LENS

4.VIEWING ANGLE:K*5=100°

5.CURRENT:150mA

6.λD: R1=620nm (Red)