

MC10EP116

Hex Differential Line Receiver

The MC10EP116/100EP116 is a 6-bit differential line receiver based on the EP16 device. The 3.0GHz bandwidth provided by the high frequency outputs makes the device ideal for buffering of very high speed oscillators.

A V_{BB} pin is available to AC couple an input signal to the device. More information on AC coupling can be found in the design handbook interfacing with ECLinPS on our website.

The design incorporates two stages of gain, internal to the device, making it an excellent choice for use in high bandwidth amplifier applications.

The differential inputs have internal clamp structures which will force the Q output of a gate in an open input condition to go to a LOW state. Thus, inputs of unused gates can be left open and will not affect the operation of the rest of the device. Note that the input clamp will take affect only if both inputs fall 2.5V below V_{CC} . All V_{CC} and V_{EE} pins must be externally connected to power supply to guarantee proper operation.

- 230ps Typical Propagation Delay
- High Bandwidth to 3.0 GHz Typical
- PECL mode: 3.0V to 5.5V V_{CC} with $V_{EE} = 0V$
- ECL mode: 0V V_{CC} with $V_{EE} = -3.0V$ to $-5.5V$
- Internal Input Resistors: Pulldown on D, Pulldown and Pullup on \bar{D}
- Q Output will default LOW with inputs open or at V_{EE}
- ESD Protection: 2KV HBM, 100V MM
- V_{BB} Output
- New Differential Input Common Mode Range
- Moisture Sensitivity Level 2
- For Additional Information, See Application Note AND8003/D
- Flammability Rating: UL-94 code V-0 @ 1/8", Oxygen Index 28 to 34
- Transistor Count: 729 devices

LOGIC DIAGRAM

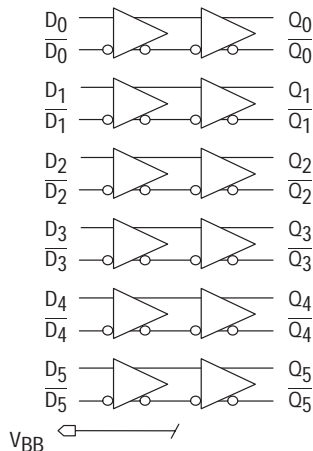

ON Semiconductor

<http://onsemi.com>

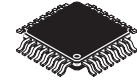

32-LEAD TQFP
FA SUFFIX
CASE 873A

MARKING DIAGRAM*

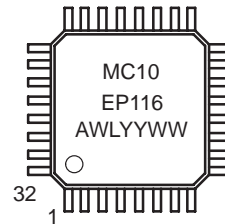

A = Assembly Location
WL = Wafer Lot
YY = Year
WW = Work Week

*For additional information, see Application Note AND8002/D

PIN DESCRIPTION

PIN	FUNCTION
$D[0:5], \bar{D}[0:5]$	ECL Differential Data Inputs
$Q[0:5], \bar{Q}[0:5]$	ECL Differential Data Outputs
VBB	Reference Voltage Output
VCC	Positive Supply
VEE	Negative, 0 Supply

ORDERING INFORMATION

Device	Package	Shipping
MC10EP116FA	TQFP	250 Units/Tray
MC10EP116FAR2	TQFP	2000 Tape & Reel

MC10EP116

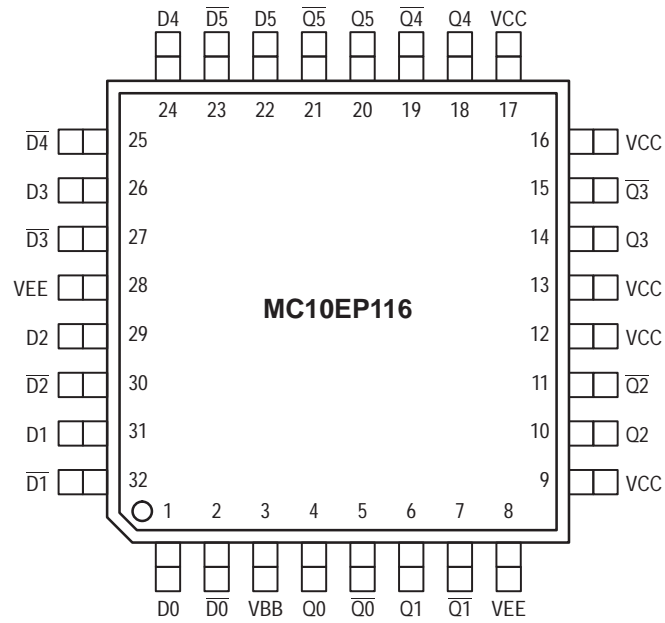

Figure 1. 32-Lead LQFP Pinout (Top View)

Warning: All VCC and VEE pins must be externally connected to Power Supply to guarantee proper operation.

MAXIMUM RATINGS*

Symbol	Parameter	Value	Unit	
V _{EE}	Power Supply (V _{CC} = 0V)	-6.0 to 0	VDC	
V _{CC}	Power Supply (V _{EE} = 0V)	6.0 to 0	VDC	
V _I	Input Voltage (V _{CC} = 0V, V _I not more negative than V _{EE})	-6.0 to 0	VDC	
V _I	Input Voltage (V _{EE} = 0V, V _I not more positive than V _{CC})	6.0 to 0	VDC	
I _{out}	Output Current	Continuous Surge	50 100	mA
I _{BB}	V _{BB} Sink/Source Current†	± 0.5	mA	
T _A	Operating Temperature Range	-40 to +85	°C	
T _{stg}	Storage Temperature	-65 to +150	°C	
θ _{JA}	Thermal Resistance (Junction-to-Ambient)	Still Air 500lfpm	80 55	°C/W
θ _{JC}	Thermal Resistance (Junction-to-Case)	12 to 17	°C/W	
T _{sol}	Solder Temperature (<2 to 3 Seconds: 245°C desired)	265	°C	

* Maximum Ratings are those values beyond which damage to the device may occur.

† Use for inputs of same package only.

MC10EP116

DC CHARACTERISTICS, ECL/LVECL ($V_{CC} = 0V$; $V_{EE} = -5.5V$ to $-3.0V$) (Note 4.)

Symbol	Characteristic	-40°C			25°C			85°C			Unit
		Min	Typ	Max	Min	Typ	Max	Min	Typ	Max	
IEE	Power Supply Current (Note 1.)	55		95	55	80	95	55		95	mA
VOH	Output HIGH Voltage (Note 2.)	-1135	-1060	-885	-1070	-945	-820	-1010	-885	-760	mV
VOL	Output LOW Voltage (Note 2.)	-1995	-1810	-1685	-1995	-1745	-1620	-1995	-1685	-1560	mV
VIH	Input HIGH Voltage Single Ended	-1210		-885	-1145		-820	-1085		-760	mV
VIL	Input LOW Voltage Single Ended	-1935		-1610	-1870		-1545	-1810		-1485	mV
VBB	Output Voltage Reference	-1575	-1475	-1375	-1540	-1440	-1340	-1515	-1415	-1315	mV
VIHCMR	Input HIGH Voltage Common Mode Range (Note 3.)	$V_{EE}+2.0$		0.0	$V_{EE}+2.0$		0.0	$V_{EE}+2.0$		0.0	V
I _{IH}	Input HIGH Current			150			150			150	μA
I _{IL}	Input LOW Current	D D	0.5 -150		0.5 -150			0.5 -150			μA

NOTE: 10EP circuits are designed to meet the DC specifications shown in the above table after thermal equilibrium has been established. The circuit is in a test socket or mounted on a printed circuit board and transverse airflow greater than 500lfpm is maintained.

1. $V_{CC} = 0V$, $V_{EE} = V_{EEmin}$ to V_{EEmax} , all other pins floating.
2. All loading with 50 ohms to $V_{CC}-2.0$ volts.
3. V_{IHCMR} min varies 1:1 with V_{EE} , max varies 1:1 with V_{CC} .
4. Input and output parameters vary 1:1 with V_{CC} .

DC CHARACTERISTICS, LVPECL ($V_{CC} = 3.3V \pm 0.3V$, $V_{EE} = 0V$) (Note 8.)

Symbol	Characteristic	-40°C			25°C			85°C			Unit
		Min	Typ	Max	Min	Typ	Max	Min	Typ	Max	
IEE	Power Supply Current (Note 5.)	55		95	55	80	95	55		95	mA
VOH	Output HIGH Voltage (Note 6.)	2165	2240	2415	2230	2355	2480	2290	2415	2540	mV
VOL	Output LOW Voltage (Note 6.)	1305	1490	1615	1305	1555	1680	1305	1615	1740	mV
VIH	Input HIGH Voltage Single Ended	2090		2415	2155		2480	2215		2540	mV
VIL	Input LOW Voltage Single Ended	1365		1690	1430		1755	1490		1815	mV
VBB	Output Voltage Reference	1725	1825	1925	1760	1860	1960	1785	1885	1985	mV
VIHCMR	Input HIGH Voltage Common Mode Range (Note 7.)	2.0		3.3	2.0		3.3	2.0		3.3	V
I _{IH}	Input HIGH Current			150			150			150	μA
I _{IL}	Input LOW Current	D D	0.5 -150		0.5 -150			0.5 -150			μA

NOTE: 10EP circuits are designed to meet the DC specifications shown in the above table after thermal equilibrium has been established. The circuit is in a test socket or mounted on a printed circuit board and transverse airflow greater than 500lfpm is maintained.

5. $V_{CC} = 3.0V$, $V_{EE} = 0V$, all other pins floating.
6. All loading with 50 ohms to $V_{CC}-2.0$ volts.
7. V_{IHCMR} min varies 1:1 with V_{EE} , max varies 1:1 with V_{CC} .
8. Input and output parameters vary 1:1 with V_{CC} .

MC10EP116

DC CHARACTERISTICS, PECL ($V_{CC} = 5.0V \pm 0.5V$, $V_{EE} = 0V$) (Note 12.)

Symbol	Characteristic	-40°C			25°C			85°C			Unit
		Min	Typ	Max	Min	Typ	Max	Min	Typ	Max	
IEE	Power Supply Current (Note 9.)	55		95	55	80	95	55		95	mA
VOH	Output HIGH Voltage (Note 10.)	3865	3940	4115	3930	4055	4180	3990	4115	4240	mV
VOL	Output LOW Voltage (Note 10.)	3005	3190	3315	3005	3255	3380	3005	3315	3440	mV
VIH	Input HIGH Voltage Single Ended	3790		4115	3855		4180	3915		4240	mV
VIL	Input LOW Voltage Single Ended	3065		3390	3130		3455	3190		3515	mV
VBB	Output Voltage Reference	3425	3525	3625	3460	3560	3660	3485	3585	3685	mV
VIHCMR	Input HIGH Voltage Common Mode Range (Note 11.)	2.0		5.0	2.0		5.0	2.0		5.0	V
I _{IH}	Input HIGH Current			150			150			150	μA
I _{IL}	Input LOW Current	D D	0.5 -150		0.5 -150			0.5 -150			μA

NOTE: 10EP circuits are designed to meet the DC specifications shown in the above table after thermal equilibrium has been established. The circuit is in a test socket or mounted on a printed circuit board and transverse airflow greater than 500lfpm is maintained.

9. $V_{CC} = 5.0V$, $V_{EE} = 0V$, all other pins floating.

10. All loading with 50 ohms to $V_{CC} - 2.0$ volts.

11. V_{IHCMR} min varies 1:1 with V_{EE} , max varies 1:1 with V_{CC} .

12. Input and output parameters vary 1:1 with V_{CC} .

AC CHARACTERISTICS ($V_{CC} = 0V$; $V_{EE} = -3.0V$ to $-5.5V$) or ($V_{CC} = 3.0V$ to $5.5V$; $V_{EE} = 0V$)

Symbol	Characteristic	-40°C			25°C			85°C			Unit	
		Min	Typ	Max	Min	Typ	Max	Min	Typ	Max		
f _{max}	Maximum Toggle Frequency (Note 13.)					3.0					GHz	
t _{PLH} , t _{PHL}	Propagation Delay to Output Differential	150	250	350	150	250	350	180	280	380	ps	
t _{SKEW}	Duty Cycle Skew (Note 14.)		5.0			5.0	20		5.0	20	ps	
t _{JITTER}	Cycle-to-Cycle Jitter		TBD			TBD			TBD		ps	
V _{PP}	Input Voltage Swing (Diff.)	150	800	1200	150	800	1200	150	800	1200	mV	
t _r t _f	Output Rise/Fall Times (20% – 80%)	Q	90	150	220	90	160	240	90	160	250	ps

13. F_{max} guaranteed for functionality only.

14. Skew is measured between outputs under identical transitions. Duty cycle skew is defined only for differential operation when the delays are measured from the cross point of the inputs to the cross point of the outputs.

MC10EP116

PACKAGE DIMENSIONS

TQFP
FA SUFFIX
32-LEAD PLASTIC PACKAGE
CASE 873A-02
ISSUE A

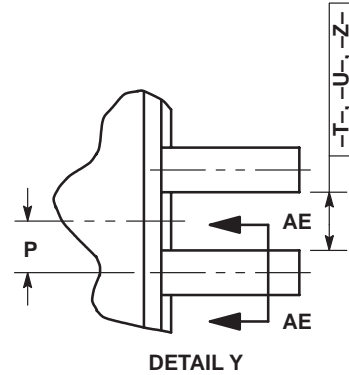
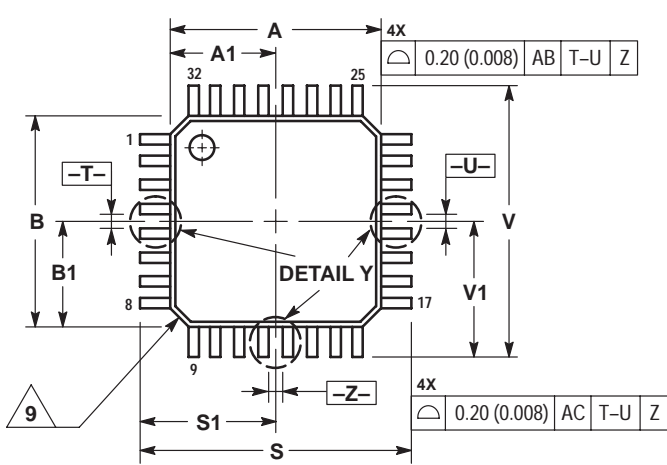

NOTES:

1. DIMENSIONING AND TOLERANCING PER ANSI Y14.5M, 1982.
2. CONTROLLING DIMENSION: MILLIMETER.
3. DATUM PLANE -AB- IS LOCATED AT BOTTOM OF LEAD AND IS COINCIDENT WITH THE LEAD WHERE THE LEAD EXITS THE PLASTIC BODY AT THE BOTTOM OF THE PARTING LINE.
4. DATUMS -T-, -U-, AND -Z- TO BE DETERMINED AT DATUM PLANE -AB-.
5. DIMENSIONS S AND V TO BE DETERMINED AT SEATING PLANE -AC-.
6. DIMENSIONS A AND B DO NOT INCLUDE MOLD PROTRUSION. ALLOWABLE PROTRUSION IS 0.250 (0.010) PER SIDE. DIMENSIONS A AND B DO INCLUDE MOLD MISMATCH AND ARE DETERMINED AT DATUM PLANE -AB-.
7. DIMENSION D DOES NOT INCLUDE DAMBAR PROTRUSION. DAMBAR PROTRUSION SHALL NOT CAUSE THE D DIMENSION TO EXCEED 0.520 (0.020).
8. MINIMUM SOLDER PLATE THICKNESS SHALL BE 0.0076 (0.0003).
9. EXACT SHAPE OF EACH CORNER MAY VARY FROM DEPICTION.

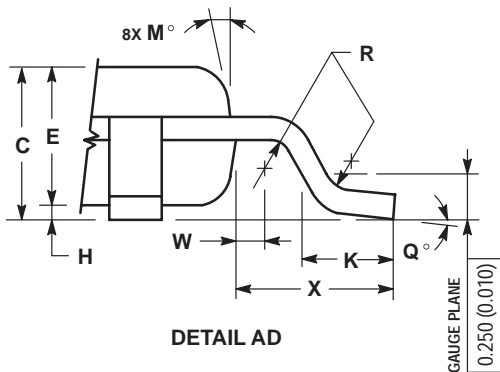
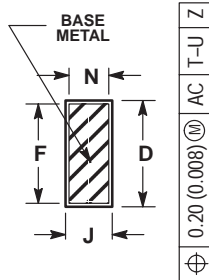
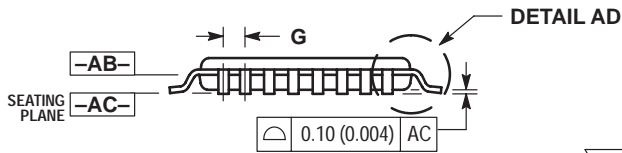

DIM	MILLIMETERS		INCHES	
	MIN	MAX	MIN	MAX
A	7.000	BSC	0.276	BSC
A1	3.500	BSC	0.138	BSC
B	7.000	BSC	0.276	BSC
B1	3.500	BSC	0.138	BSC
C	1.400	1.600	0.055	0.063
D	0.300	0.450	0.012	0.018
E	1.350	1.450	0.053	0.057
F	0.300	0.400	0.012	0.016
G	0.800	BSC	0.031	BSC
H	0.050	0.150	0.002	0.006
J	0.090	0.200	0.004	0.008
K	0.500	0.700	0.020	0.028
M	12°	REF	12°	REF
N	0.090	0.160	0.004	0.006
P	0.400	BSC	0.016	BSC
Q	1°	5°	1°	5°
R	0.150	0.250	0.006	0.010
S	9.000	BSC	0.354	BSC
S1	4.500	BSC	0.177	BSC
V	9.000	BSC	0.354	BSC
V1	4.500	BSC	0.177	BSC
W	0.200	REF	0.008	REF
X	1.000	REF	0.039	REF

Notes

Notes

ON Semiconductor and  are trademarks of Semiconductor Components Industries, LLC (SCILLC). SCILLC reserves the right to make changes without further notice to any products herein. SCILLC makes no warranty, representation or guarantee regarding the suitability of its products for any particular purpose, nor does SCILLC assume any liability arising out of the application or use of any product or circuit, and specifically disclaims any and all liability, including without limitation special, consequential or incidental damages. "Typical" parameters which may be provided in SCILLC data sheets and/or specifications can and do vary in different applications and actual performance may vary over time. All operating parameters, including "Typicals" must be validated for each customer application by customer's technical experts. SCILLC does not convey any license under its patent rights nor the rights of others. SCILLC products are not designed, intended, or authorized for use as components in systems intended for surgical implant into the body, or other applications intended to support or sustain life, or for any other application in which the failure of the SCILLC product could create a situation where personal injury or death may occur. Should Buyer purchase or use SCILLC products for any such unintended or unauthorized application, Buyer shall indemnify and hold SCILLC and its officers, employees, subsidiaries, affiliates, and distributors harmless against all claims, costs, damages, and expenses, and reasonable attorney fees arising out of, directly or indirectly, any claim of personal injury or death associated with such unintended or unauthorized use, even if such claim alleges that SCILLC was negligent regarding the design or manufacture of the part. SCILLC is an Equal Opportunity/Affirmative Action Employer.

PUBLICATION ORDERING INFORMATION

NORTH AMERICA Literature Fulfillment:

Literature Distribution Center for ON Semiconductor
P.O. Box 5163, Denver, Colorado 80217 USA
Phone: 303-675-2175 or 800-344-3860 Toll Free USA/Canada
Fax: 303-675-2176 or 800-344-3867 Toll Free USA/Canada
Email: ONlit@hibbertco.com
Fax Response Line: 303-675-2167 or 800-344-3810 Toll Free USA/Canada

N. American Technical Support: 800-282-9855 Toll Free USA/Canada

EUROPE: LDC for ON Semiconductor – European Support

German Phone: (+1) 303-308-7140 (M-F 1:00pm to 5:00pm Munich Time)
Email: ONlit-german@hibbertco.com
French Phone: (+1) 303-308-7141 (M-F 1:00pm to 5:00pm Toulouse Time)
Email: ONlit-french@hibbertco.com
English Phone: (+1) 303-308-7142 (M-F 12:00pm to 5:00pm UK Time)
Email: ONlit@hibbertco.com

EUROPEAN TOLL-FREE ACCESS*: 00-800-4422-3781

*Available from Germany, France, Italy, England, Ireland

CENTRAL/SOUTH AMERICA:

Spanish Phone: 303-308-7143 (Mon-Fri 8:00am to 5:00pm MST)
Email: ONlit-spanish@hibbertco.com

ASIA/PACIFIC: LDC for ON Semiconductor – Asia Support

Phone: 303-675-2121 (Tue-Fri 9:00am to 1:00pm, Hong Kong Time)
Toll Free from Hong Kong & Singapore:
001-800-4422-3781
Email: ONlit-asia@hibbertco.com

JAPAN: ON Semiconductor, Japan Customer Focus Center
4-32-1 Nishi-Gotanda, Shinagawa-ku, Tokyo, Japan 141-8549

Phone: 81-3-5740-2745
Email: r14525@onsemi.com

ON Semiconductor Website: <http://onsemi.com>

For additional information, please contact your local Sales Representative.