

# DTA114EXV3T1 Series

Preferred Devices

## Digital Transistors (BRT)

### PNP Silicon Surface Mount Transistors with Monolithic Bias Resistor Network

This new series of digital transistors is designed to replace a single device and its external resistor bias network. The digital transistor contains a single transistor with a monolithic bias network consisting of two resistors; a series base resistor and a base-emitter resistor. The digital transistor eliminates these individual components by integrating them into a single device. The use of a digital transistor can reduce both system cost and board space. The device is housed in the SC-89 package which is designed for low power surface mount applications.

- Simplifies Circuit Design
- Reduces Board Space
- Reduces Component Count
- Available in 8 mm, 7 inch/3000 Unit Tape & Reel
- Lead-Free Plating (Pure Sn)

#### MAXIMUM RATINGS ( $T_A = 25^\circ\text{C}$ unless otherwise noted)

| Rating                    | Symbol    | Value | Unit |
|---------------------------|-----------|-------|------|
| Collector-Base Voltage    | $V_{CBO}$ | 50    | Vdc  |
| Collector-Emitter Voltage | $V_{CEO}$ | 50    | Vdc  |
| Collector Current         | $I_C$     | 100   | mAdc |



ON Semiconductor®

<http://onsemi.com>

## PNP SILICON DIGITAL TRANSISTORS

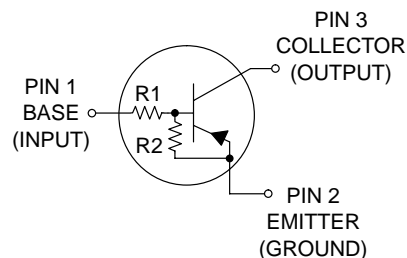

SC-89  
CASE 463C  
STYLE 1

#### MARKING DIAGRAM

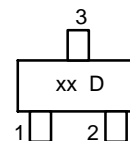

xx = Specific Device Code  
(See Marking Table on page 2)  
D = Date Code

Preferred devices are recommended choices for future use and best overall value.

## DTA114EXV3T1 Series

### DEVICE MARKING AND RESISTOR VALUES

| Device       | Marking | R1 (K) | R2 (K) | Shipping†        |
|--------------|---------|--------|--------|------------------|
| DTA114EXV3T1 | 6A      | 10     | 10     | 3000/Tape & Reel |
| DTA124EXV3T1 | 6B      | 22     | 22     |                  |
| DTA144EXV3T1 | 6C      | 47     | 47     |                  |
| DTA114YXV3T1 | 6D      | 10     | 47     |                  |
| DTA114TXV3T1 | 6E      | 10     | ∞      |                  |
| DTA143TXV3T1 | 6F      | 4.7    | ∞      |                  |
| DTA144WXV3T1 | 6P      | 47     | 22     |                  |
| DTA144TXV3T1 | 6T      | 47     | ∞      |                  |
| DTA143XXV3T1 | 6R      | 4.7    | 10     |                  |

†For information on tape and reel specifications, including part orientation and tape sizes, please refer to our Tape and Reel Packaging Specifications Brochure, BRD8011/D.

### THERMAL CHARACTERISTICS

| Characteristic   | Symbol          | Max         | Unit                       |
|--|-----------------|-------------|----------------------------|
| Total Device Dissipation,<br>FR-4 Board (Note 1) @ $T_A = 25^\circ\text{C}$<br>Derate above $25^\circ\text{C}$ | $P_D$           | 200<br>1.6  | mW<br>mW/ $^\circ\text{C}$ |
| Thermal Resistance, Junction to Ambient (Note 1)   | $R_{\theta JA}$ | 600         | $^\circ\text{C}/\text{W}$  |
| Total Device Dissipation,<br>FR-4 Board (Note 2) @ $T_A = 25^\circ\text{C}$<br>Derate above $25^\circ\text{C}$ | $P_D$           | 300<br>2.4  | mW<br>mW/ $^\circ\text{C}$ |
| Thermal Resistance, Junction to Ambient (Note 2)   | $R_{\theta JA}$ | 400         | $^\circ\text{C}/\text{W}$  |
| Junction and Storage Temperature Range   | $T_J, T_{stg}$  | -55 to +150 | $^\circ\text{C}$           |

1. FR-4 @ Minimum Pad.
2. FR-4 @  $1.0 \times 1.0$  Inch Pad.

# DTA114EXV3T1 Series

## ELECTRICAL CHARACTERISTICS ( $T_A = 25^\circ\text{C}$ unless otherwise noted)

| Characteristic   | Symbol        | Min | Typ | Max  | Unit |
|--|---------------|-----|-----|------|------|
| <b>OFF CHARACTERISTICS</b>   |               |     |     |      |      |
| Collector–Base Cutoff Current ( $V_{CB} = 50\text{ V}, I_E = 0$ )                  | $I_{CBO}$     | –   | –   | 100  | nAdc |
| Collector–Emitter Cutoff Current ( $V_{CE} = 50\text{ V}, I_B = 0$ )               | $I_{CEO}$     | –   | –   | 500  | nAdc |
| Emitter–Base Cutoff Current<br>( $V_{EB} = 6.0\text{ V}, I_C = 0$ )                | $I_{EBO}$     | –   | –   | 0.5  | mAdc |
|  | DTA114EXV3T1  | –   | –   | 0.2  |      |
|  | DTA124EXV3T1  | –   | –   | 0.1  |      |
|  | DTA144EXV3T1  | –   | –   | 0.2  |      |
|  | DTA114YXV3T1  | –   | –   | 0.9  |      |
|  | DTA114TXV3T1  | –   | –   | 1.9  |      |
|  | DTA143TXV3T1  | –   | –   | 0.13 |      |
|  | DTA144WXV3T1  | –   | –   | 0.2  |      |
|  | DTA144TXV3T1  | –   | –   | 1.0  |      |
|  | DTA143XXV3T1  | –   | –   |      |      |
| Collector–Base Breakdown Voltage ( $I_C = 10\ \mu\text{A}, I_E = 0$ )              | $V_{(BR)CBO}$ | 50  | –   | –    | Vdc  |
| Collector–Emitter Breakdown Voltage (Note 3)<br>( $I_C = 2.0\text{ mA}, I_B = 0$ ) | $V_{(BR)CEO}$ | 50  | –   | –    | Vdc  |

## ON CHARACTERISTICS (Note 3)

|   |               |     |     |      |     |
|---|---------------|-----|-----|------|-----|
| DC Current Gain<br>( $V_{CE} = 10\text{ V}, I_C = 5.0\text{ mA}$ )  | $h_{FE}$      | 35  | 60  | –    |     |
|   | DTA114EXV3T1  | 60  | 100 | –    |     |
|   | DTA124EXV3T1  | 80  | 140 | –    |     |
|   | DTA144EXV3T1  | 80  | 140 | –    |     |
|   | DTA114YXV3T1  | 160 | 250 | –    |     |
|   | DTA114TXV3T1  | 160 | 250 | –    |     |
|   | DTA143TXV3T1  | 80  | 140 | –    |     |
|   | DTA144WXV3T1  | 160 | 250 | –    |     |
|   | DTA144TXV3T1  | 20  | 35  | –    |     |
|   | DTA143XXV3T1  |     |     |      |     |
| Collector–Emitter Saturation Voltage ( $I_C = 10\text{ mA}, I_E = 0.3\text{ mA}$ )<br>( $I_C = 10\text{ mA}, I_B = 5.0\text{ mA}$ ) DTA123EXV3T1<br>( $I_C = 10\text{ mA}, I_B = 1.0\text{ mA}$ ) DTA114TXV3T1/ DTA143TXV3T1/<br>DTA143ZXV3T1/DTA124XXV3T1/DTA143EXV3T1 | $V_{CE(sat)}$ | –   | –   | 0.25 | Vdc |
| Output Voltage (on)<br>( $V_{CC} = 5.0\text{ V}, V_B = 2.5\text{ V}, R_L = 1.0\text{ k}\Omega$ )  | $V_{OL}$      | –   | –   | 0.2  | Vdc |
|   | DTA114EXV3T1  | –   | –   | 0.2  |     |
|   | DTA124EXV3T1  | –   | –   | 0.2  |     |
|   | DTA114YXV3T1  | –   | –   | 0.2  |     |
|   | DTA114TXV3T1  | –   | –   | 0.2  |     |
|   | DTA143TXV3T1  | –   | –   | 0.2  |     |
|   | DTA144EXV3T1  | –   | –   | 0.2  |     |
| ( $V_{CC} = 5.0\text{ V}, V_B = 3.5\text{ V}, R_L = 1.0\text{ k}\Omega$ )   | DTA144EXV3T1  | –   | –   | 0.2  |     |
| ( $V_{CC} = 5.0\text{ V}, V_B = 4.0\text{ V}, R_L = 1.0\text{ k}\Omega$ )   | DTA144WXV3T1  | –   | –   | 0.2  |     |
|   | DTA144TXV3T1  | –   | –   | 0.2  |     |
|   | DTA143XXV3T1  | –   | –   | 0.2  |     |
| Output Voltage (off) ( $V_{CC} = 5.0\text{ V}, V_B = 0.5\text{ V}, R_L = 1.0\text{ k}\Omega$ )<br>( $V_{CC} = 5.0\text{ V}, V_B = 0.25\text{ V}, R_L = 1.0\text{ k}\Omega$ )  | $V_{OH}$      | 4.9 | –   | –    | Vdc |
|   | DTA114TXV3T1  |     |     |      |     |
|   | DTA143TXV3T1  |     |     |      |     |

3. Pulse Test: Pulse Width < 300  $\mu\text{s}$ , Duty Cycle < 2.0%.

# DTA114EXV3T1 Series

**ELECTRICAL CHARACTERISTICS (continued)** ( $T_A = 25^\circ\text{C}$  unless otherwise noted)

| Characteristic                             | Symbol         | Min  | Typ       | Max  | Unit |            |
|--|----------------|--|-----------|------|------|------------|
| Input Resistor                             | DTA114EXV3T1   | R1   | 7.0       | 10   | 13   | k $\Omega$ |
|  | DTA124EXV3T1   |  | 15.4      | 22   | 28.6 |            |
|  | DTA144EXV3T1   |  | 32.9      | 47   | 61.1 |            |
|  | DTA114YXV3T1   |  | 7.0       | 10   | 13   |            |
|  | DTA114TXV3T1   |  | 7.0       | 10   | 13   |            |
|  | DTA143TXV3T1   |  | 3.3       | 4.7  | 6.1  |            |
|  | DTA144WXV3T1   |  | 32.9      | 47   | 61.1 |            |
|  | DTA144TXV3T1   |  | 32.9      | 47   | 61.1 |            |
|  | DTA143XXV3T1   |  | 3.3       | 4.7  | 6.1  |            |
|  | Resistor Ratio | DTA114EXV3T1/DTA124EXV3T1/<br>DTA144EXV3T1 | $R_1/R_2$ | 0.8  | 1.0  |            |
| DTA114YXV3T1                               |                |  | 0.17      | 0.21 | 0.25 |            |
| DTA114TXV3T1/DTA143TXV3T1/<br>DTA144TXV3T1 |                |  | -         | -    | -    |            |
| DTA144WXV3T1                               |                |  | 1.7       | 2.1  | 2.6  |            |
| DTA143XXV3T1                               |                |  | 0.38      | 0.47 | 0.56 |            |

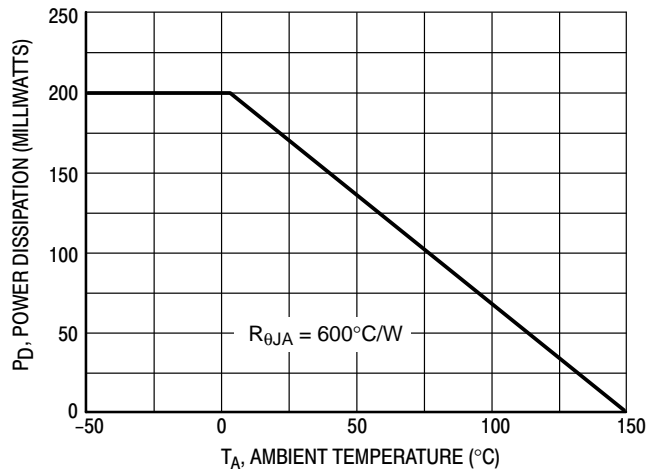

**Figure 1. Derating Curve**

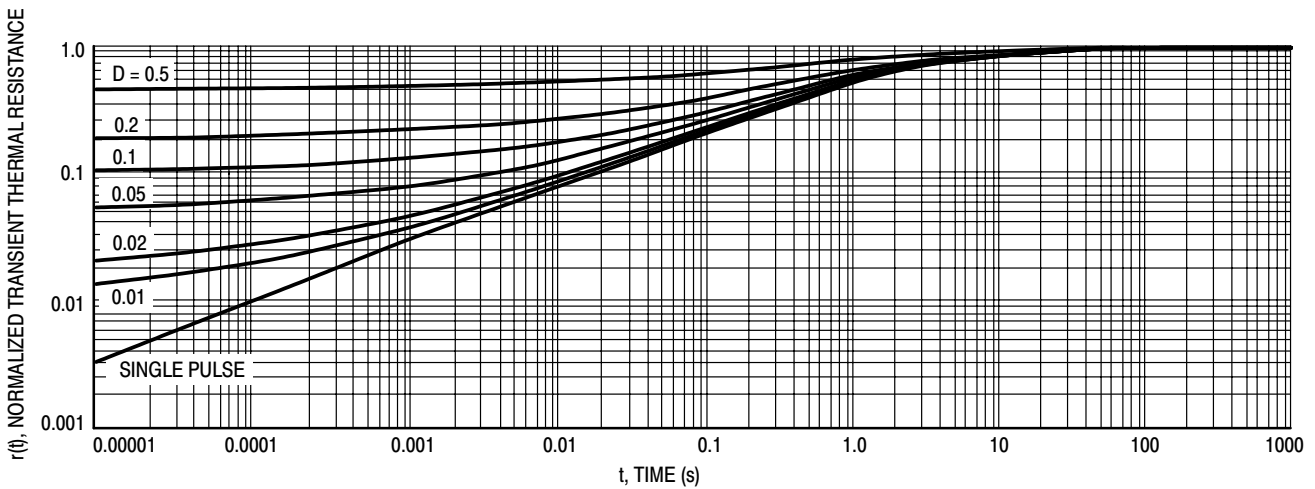

**Figure 2. Normalized Thermal Response**

# DTA114EXV3T1 Series

## TYPICAL ELECTRICAL CHARACTERISTICS – DTA114EXV3T1

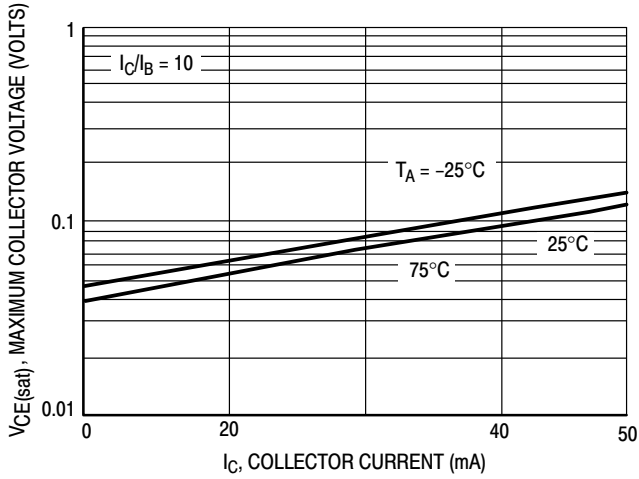

Figure 3.  $V_{CE(sat)}$  versus  $I_C$

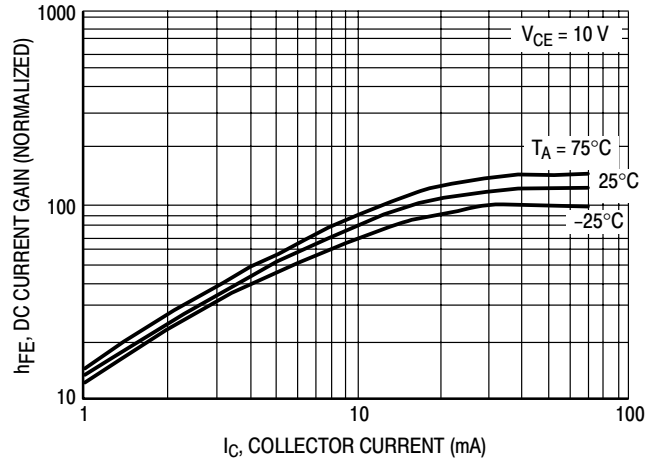

Figure 4. DC Current Gain

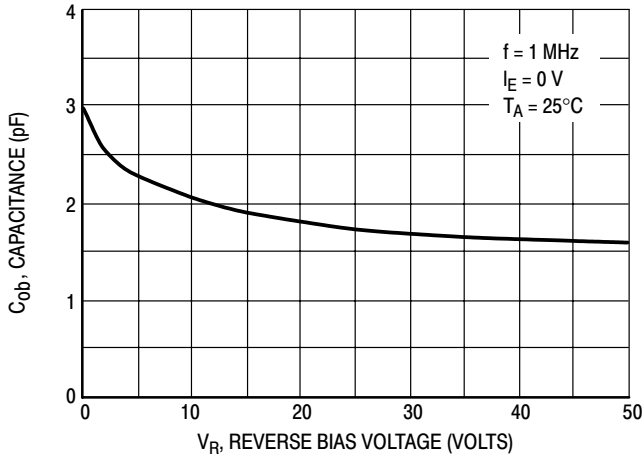

Figure 5. Output Capacitance

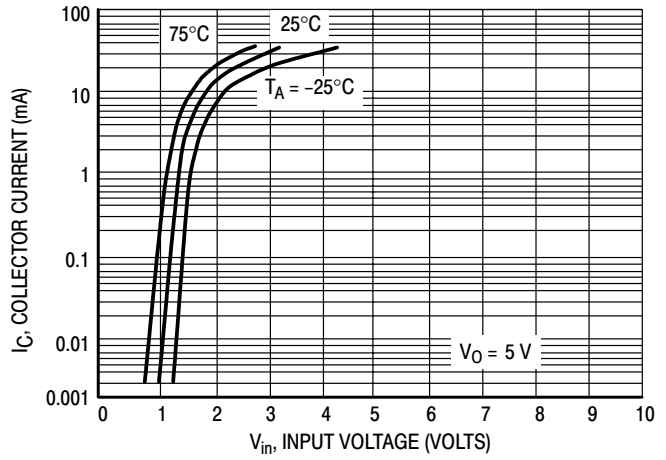

Figure 6. Output Current versus Input Voltage

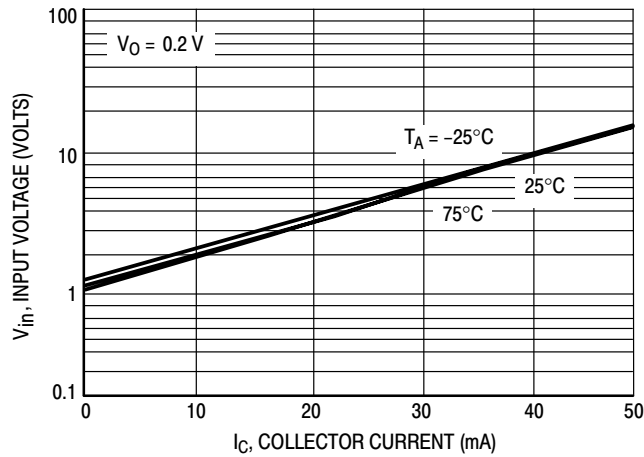

Figure 7. Input Voltage versus Output Current

# DTA114EXV3T1 Series

## TYPICAL ELECTRICAL CHARACTERISTICS – DTA124EXV3T1

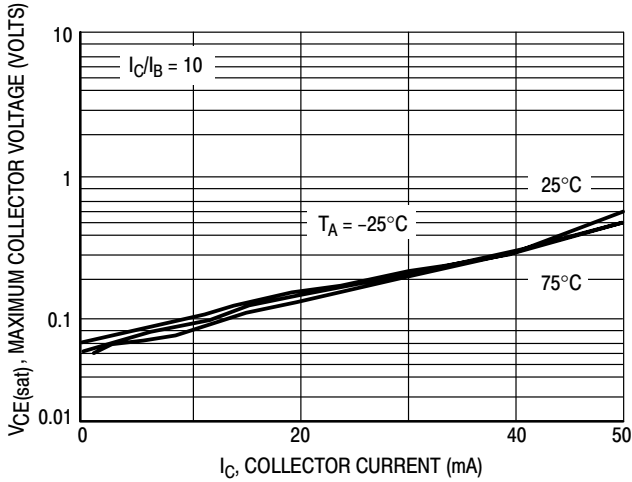

Figure 8.  $V_{CE(sat)}$  versus  $I_C$

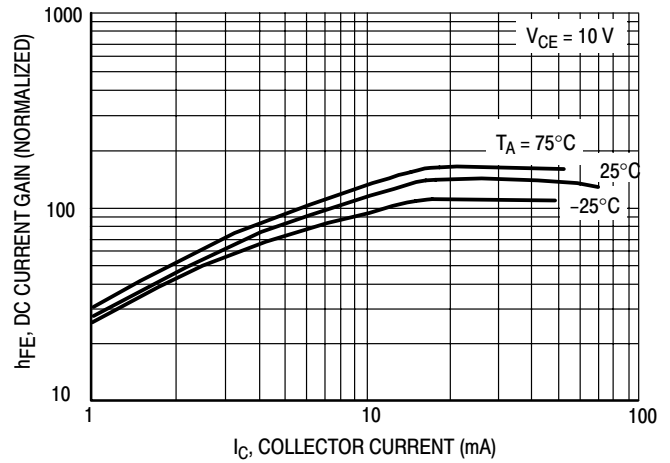

Figure 9. DC Current Gain

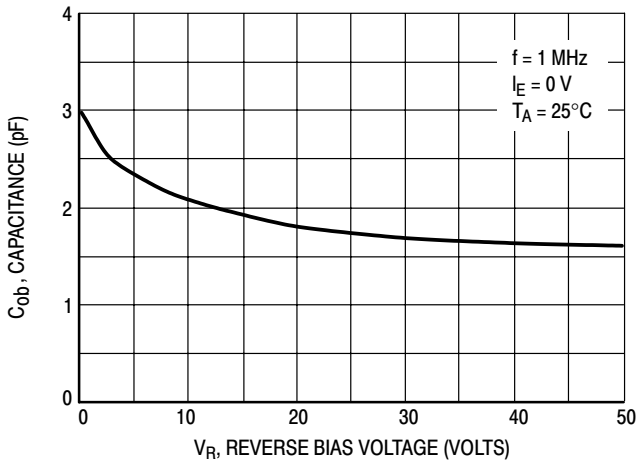

Figure 10. Output Capacitance

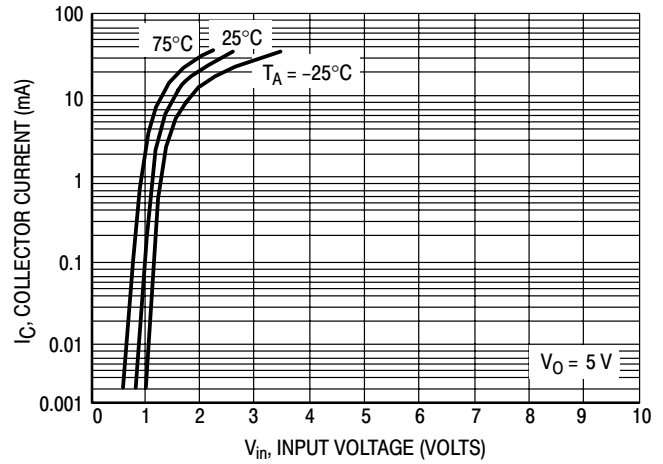

Figure 11. Output Current versus Input Voltage

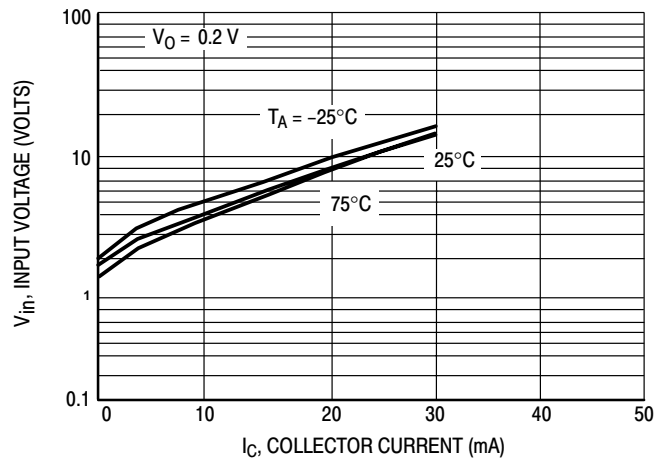

Figure 12. Input Voltage versus Output Current

# DTA114EXV3T1 Series

## TYPICAL ELECTRICAL CHARACTERISTICS – DTA144EXV3T1

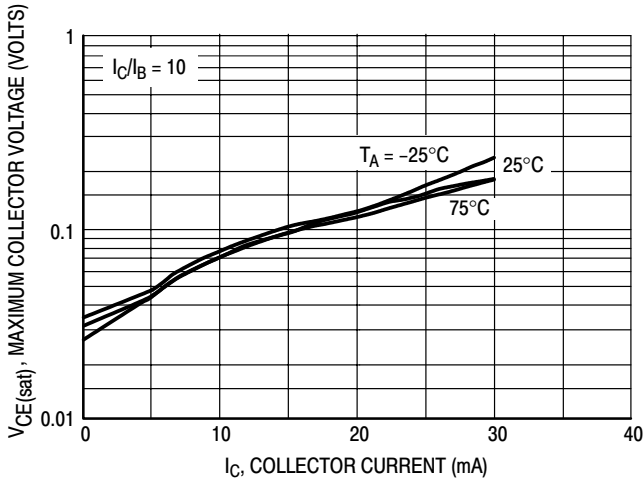

Figure 13.  $V_{CE(sat)}$  versus  $I_C$

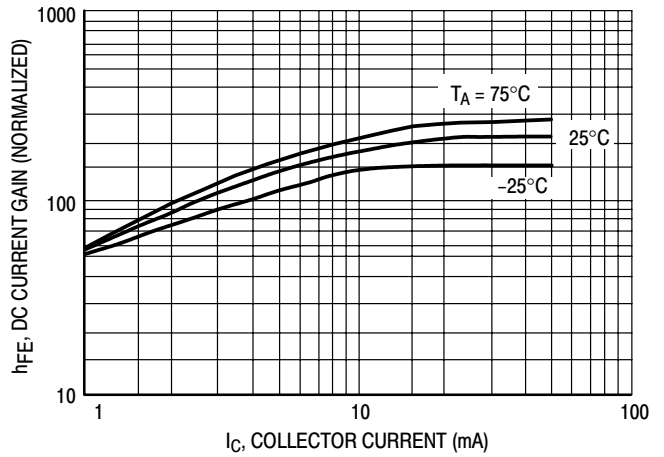

Figure 14. DC Current Gain

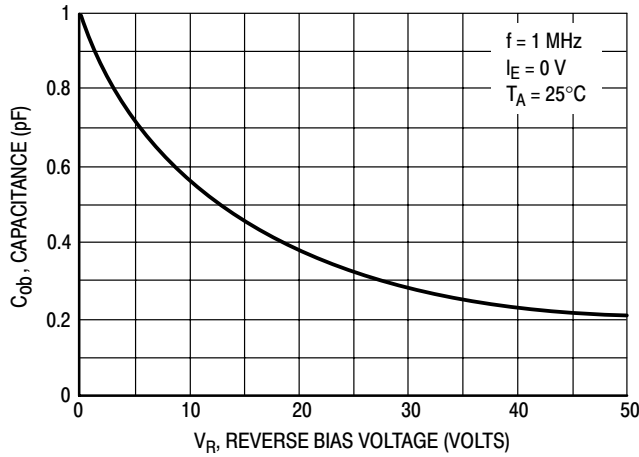

Figure 15. Output Capacitance

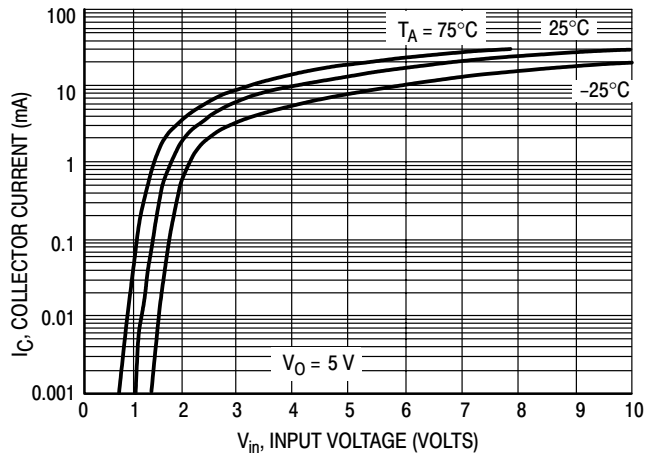

Figure 16. Output Current versus Input Voltage

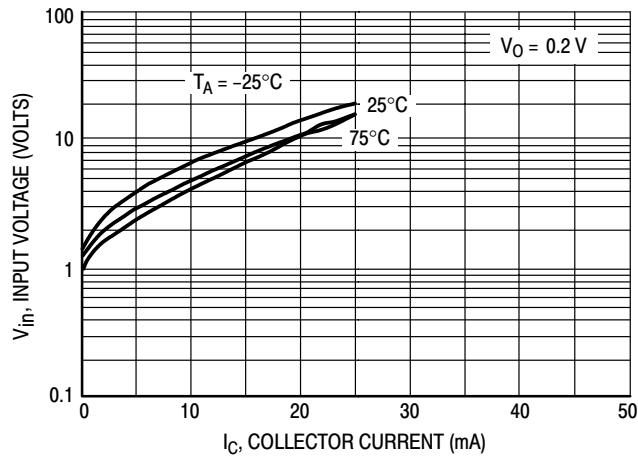

Figure 17. Input Voltage versus Output Current

# DTA114EXV3T1 Series

## TYPICAL ELECTRICAL CHARACTERISTICS – DTA114YXV3T1

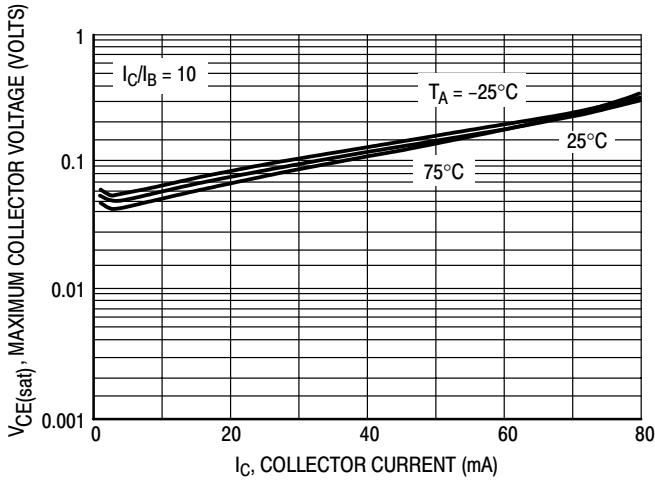

Figure 18.  $V_{CE(sat)}$  versus  $I_C$

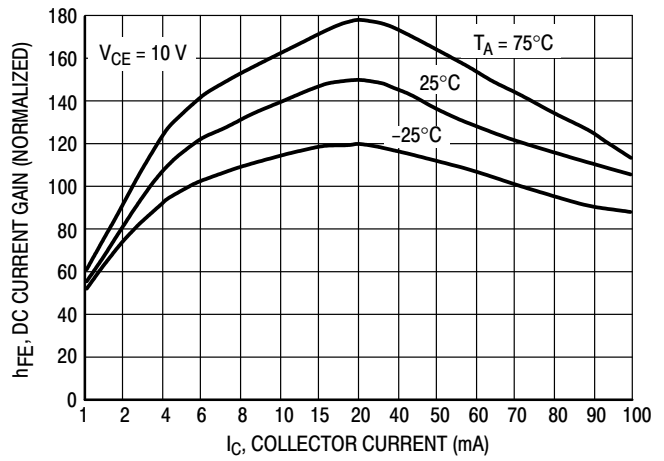

Figure 19. DC Current Gain

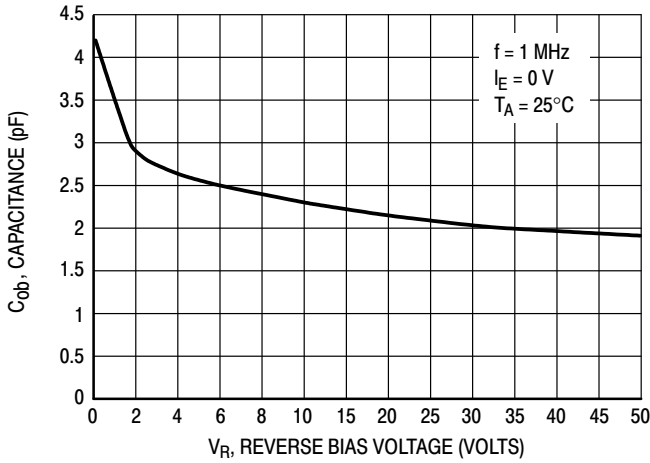

Figure 20. Output Capacitance

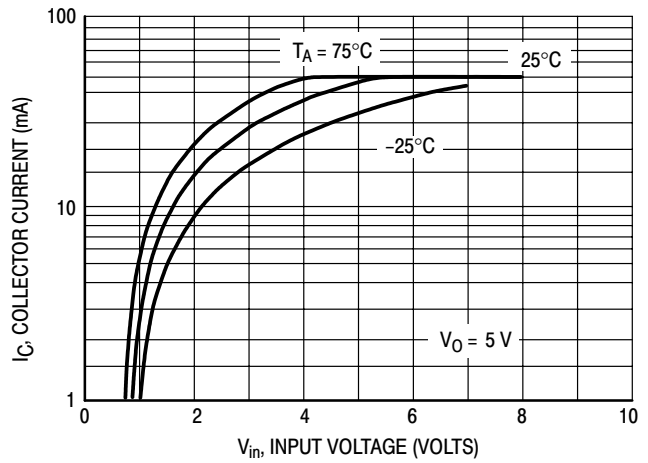

Figure 21. Output Current versus Input Voltage

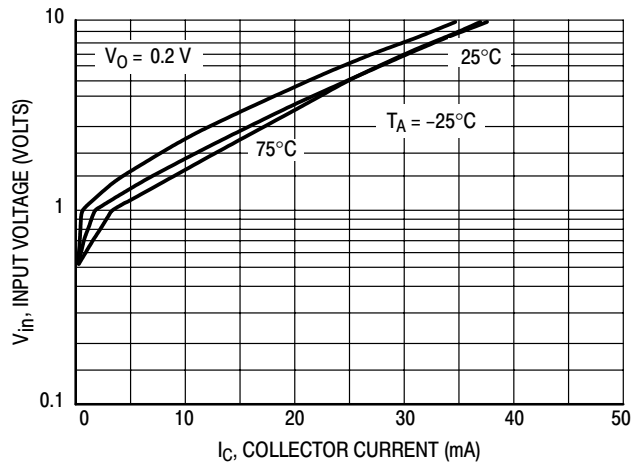

Figure 22. Input Voltage versus Output Current



TYPICAL ELECTRICAL CHARACTERISTICS — DTA144WXV3T1

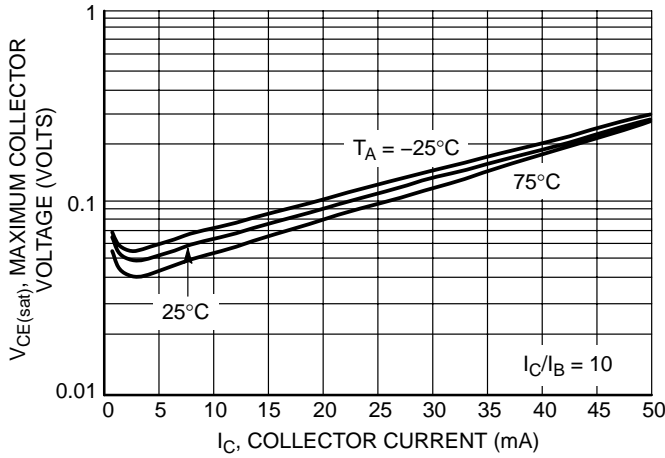

Figure 23. Maximum Collector Voltage versus Collector Current

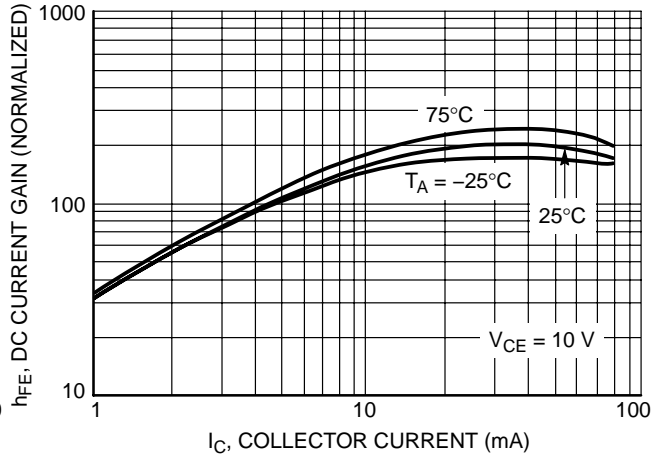

Figure 24. DC Current Gain

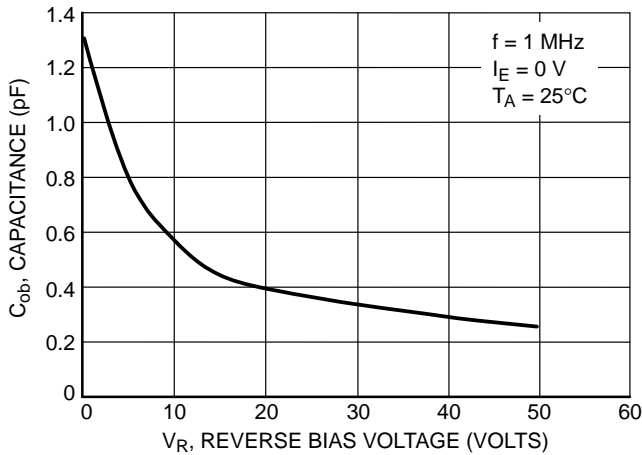

Figure 25. Output Capacitance

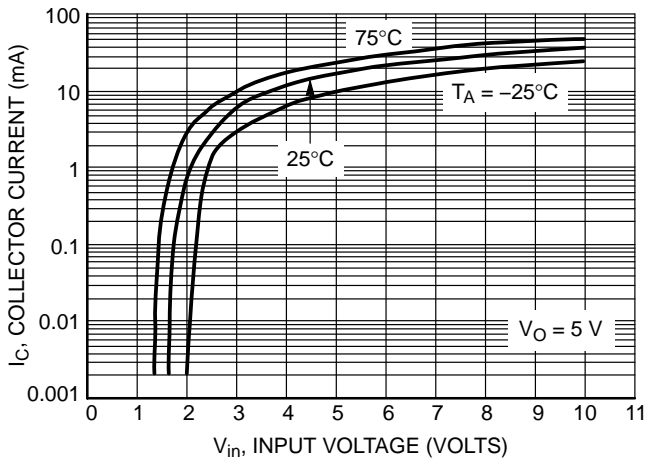

Figure 26. Output Current versus Input Voltage

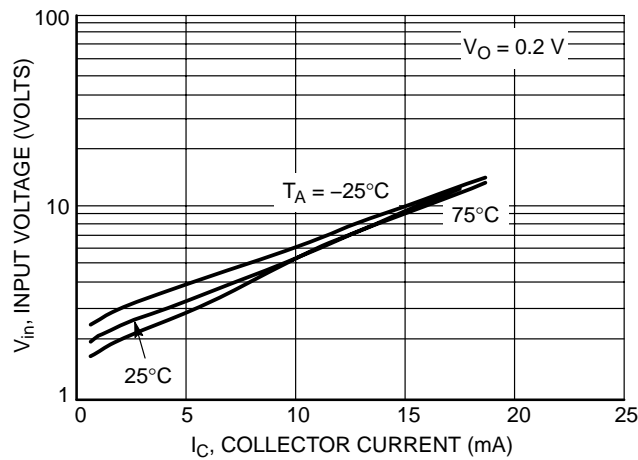

Figure 27. Input Voltage versus Output Current

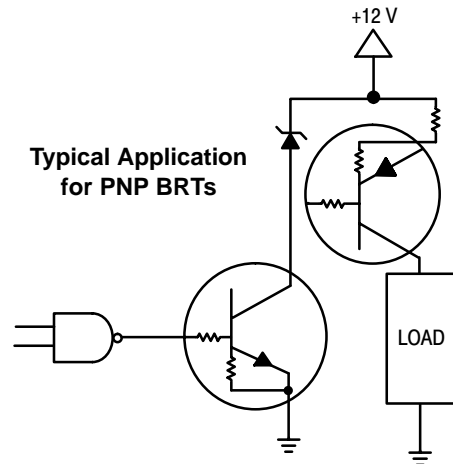
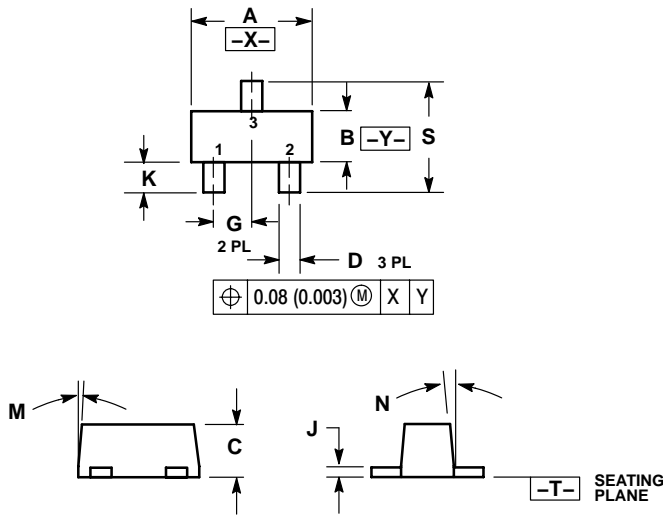

Figure 28. Inexpensive, Unregulated Current Source

# DTA114EXV3T1 Series

## PACKAGE DIMENSIONS

SC-89  
CASE 463C-03  
ISSUE C



### NOTES:

1. DIMENSIONING AND TOLERANCING PER ANSI Y14.5M, 1982.
2. CONTROLLING DIMENSION: MILLIMETERS
3. MAXIMUM LEAD THICKNESS INCLUDES LEAD FINISH THICKNESS. MINIMUM LEAD THICKNESS IS THE MINIMUM THICKNESS OF BASE MATERIAL.
4. 463C-01 OBSOLETE, NEW STANDARD 463C-02.

| DIM | MILLIMETERS |      |      | INCHES    |       |       |
|-----|-------------|------|------|-----------|-------|-------|
|     | MIN         | NOM  | MAX  | MIN       | NOM   | MAX   |
| A   | 1.50        | 1.60 | 1.70 | 0.059     | 0.063 | 0.067 |
| B   | 0.75        | 0.85 | 0.95 | 0.030     | 0.034 | 0.040 |
| C   | 0.60        | 0.70 | 0.80 | 0.024     | 0.028 | 0.031 |
| D   | 0.23        | 0.28 | 0.33 | 0.009     | 0.011 | 0.013 |
| G   | 0.50 BSC    |      |      | 0.020 BSC |       |       |
| H   | 0.53 REF    |      |      | 0.021 REF |       |       |
| J   | 0.10        | 0.15 | 0.20 | 0.004     | 0.006 | 0.008 |
| K   | 0.30        | 0.40 | 0.50 | 0.012     | 0.016 | 0.020 |
| L   | 1.10 REF    |      |      | 0.043 REF |       |       |
| M   | ---         | ---  | 10   | ---       | ---   | 10    |
| N   | ---         | ---  | 10   | ---       | ---   | 10    |
| S   | 1.50        | 1.60 | 1.70 | 0.059     | 0.063 | 0.067 |

### STYLE 1:

1. BASE
2. EMITTER
3. COLLECTOR

ON Semiconductor and are registered trademarks of Semiconductor Components Industries, LLC (SCILLC). SCILLC reserves the right to make changes without further notice to any products herein. SCILLC makes no warranty, representation or guarantee regarding the suitability of its products for any particular purpose, nor does SCILLC assume any liability arising out of the application or use of any product or circuit, and specifically disclaims any and all liability, including without limitation special, consequential or incidental damages. "Typical" parameters which may be provided in SCILLC data sheets and/or specifications can and do vary in different applications and actual performance may vary over time. All operating parameters, including "Typicals" must be validated for each customer application by customer's technical experts. SCILLC does not convey any license under its patent rights nor the rights of others. SCILLC products are not designed, intended, or authorized for use as components in systems intended for surgical implant into the body, or other applications intended to support or sustain life, or for any other application in which the failure of the SCILLC product could create a situation where personal injury or death may occur. Should Buyer purchase or use SCILLC products for any such unintended or unauthorized application, Buyer shall indemnify and hold SCILLC and its officers, employees, subsidiaries, affiliates, and distributors harmless against all claims, costs, damages, and expenses, and reasonable attorney fees arising out of, directly or indirectly, any claim of personal injury or death associated with such unintended or unauthorized use, even if such claim alleges that SCILLC was negligent regarding the design or manufacture of the part. SCILLC is an Equal Opportunity/Affirmative Action Employer. This literature is subject to all applicable copyright laws and is not for resale in any manner.

### PUBLICATION ORDERING INFORMATION

#### LITERATURE FULFILLMENT:

Literature Distribution Center for ON Semiconductor  
P.O. Box 5163, Denver, Colorado 80217 USA

Phone: 303-675-2175 or 800-344-3860 Toll Free USA/Canada

Fax: 303-675-2176 or 800-344-3867 Toll Free USA/Canada

Email: orderlit@onsemi.com

N. American Technical Support: 800-282-9855 Toll Free  
USA/Canada

Japan: ON Semiconductor, Japan Customer Focus Center

2-9-1 Kamimeguro, Meguro-ku, Tokyo, Japan 153-0051

Phone: 81-3-5773-3850

ON Semiconductor Website: <http://onsemi.com>

Order Literature: <http://www.onsemi.com/litorder>

For additional information, please contact your  
local Sales Representative.