

## LP3963/LP3966

# 3A Fast Ultra Low Dropout Linear Regulators

### General Description

The LP3963/LP3966 series of fast ultra low-dropout linear regulators operate from a +2.5V to +7.0V input supply. Wide range of preset output voltage options are available. These ultra low dropout linear regulators respond very fast to step changes in load which makes them suitable for low voltage microprocessor applications. The LP3963/LP3966 are developed on a CMOS process which allows low quiescent current operation independent of output load current. This CMOS process also allows the LP3963/LP3966 to operate under extremely low dropout conditions.

**Dropout Voltage:** Ultra low dropout voltage; typically 80mV at 300mA load current and 800mV at 3A load current.

**Ground Pin Current:** Typically 6mA at 3A load current.

**Shutdown Mode:** Typically 15 $\mu$ A quiescent current when the shutdown pin is pulled low.

**Error Flag:** Error flag goes low when the output voltage drops 10% below nominal value (for LP3963).

**SENSE:** Sense pin improves regulation at remote loads. (For LP3966)

**Precision Output Voltage:** Multiple output voltage options are available ranging from 1.2V to 5.0V and adjustable, with a guaranteed accuracy of  $\pm 1.5\%$  at room temperature, and  $\pm 3.0\%$  over all conditions (varying line, load, and temperature).

### Features

- Ultra low dropout voltage
- Low ground pin current
- Load regulation of 0.06%
- 15 $\mu$ A quiescent current in shutdown mode
- Guaranteed output current of 3A DC
- Available in TO-263 and TO-220 packages
- Output voltage accuracy  $\pm 1.5\%$
- Error flag indicates output status (LP3963)
- Sense option improves better load regulation (LP3966)
- Extremely low output capacitor requirements
- Overtemperature/overcurrent protection
- $-40^{\circ}\text{C}$  to  $+125^{\circ}\text{C}$  junction temperature range

### Applications

- Microprocessor power supplies
- GTL, GTL+, BTL, and SSTL bus terminators
- Power supplies for DSPs
- SCSI terminator
- Post regulators
- High efficiency linear regulators
- Battery chargers
- Other battery powered applications

### Typical Application Circuits

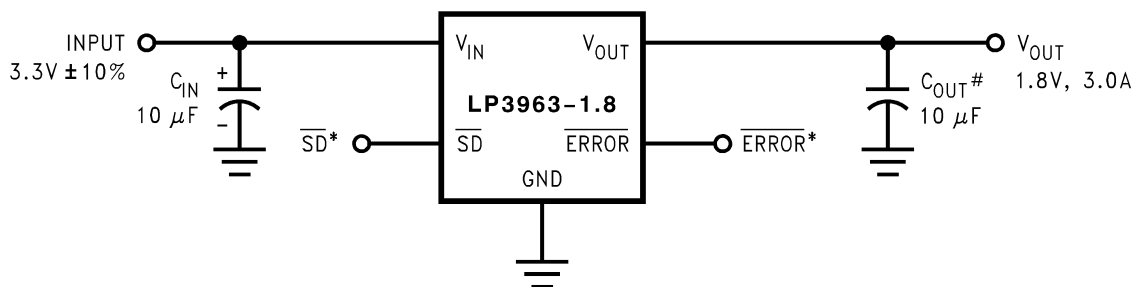

DS101267-1

# Minimum output capacitance is 10  $\mu$ F to ensure stability over full load current range. More capacitance provides superior dynamic performance and additional stability margin.

\*SD and ERROR pins must be pulled high through a 10k $\Omega$  pull-up resistor. Connect the  $\overline{\text{ERROR}}$  pin to ground if this function is not used. See applications section for more information.

Typical Application Circuits (Continued)

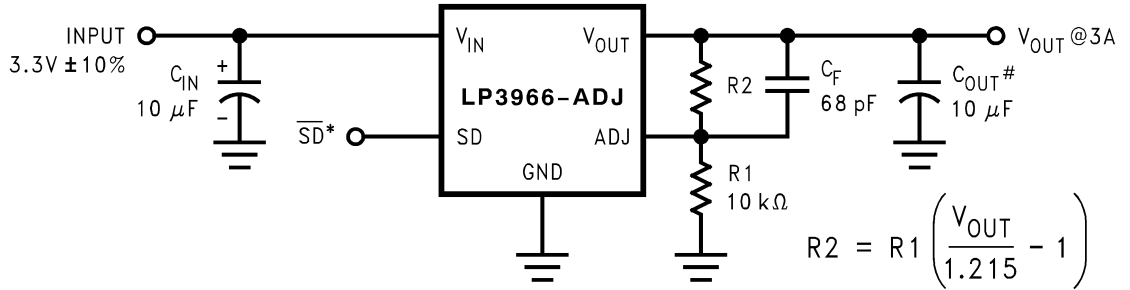
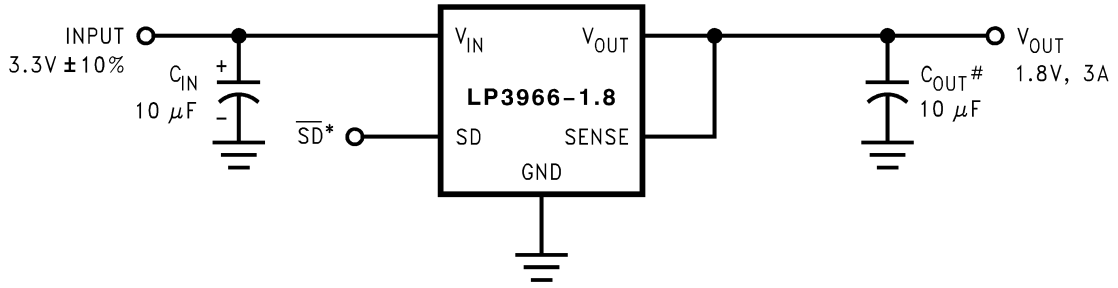

$$R2 = R1 \left( \frac{V_{OUT}}{1.215} - 1 \right)$$

DS101267-34

# Minimum output capacitance is 10 μF to ensure stability over full load current range. More capacitance provides superior dynamic performance and additional stability margin.

\*SD and ERROR pins must be pulled high through a 10kΩ pull-up resistor. Connect the ERROR pin to ground if this function is not used. See applications section for more information.

Block Diagram LP3963

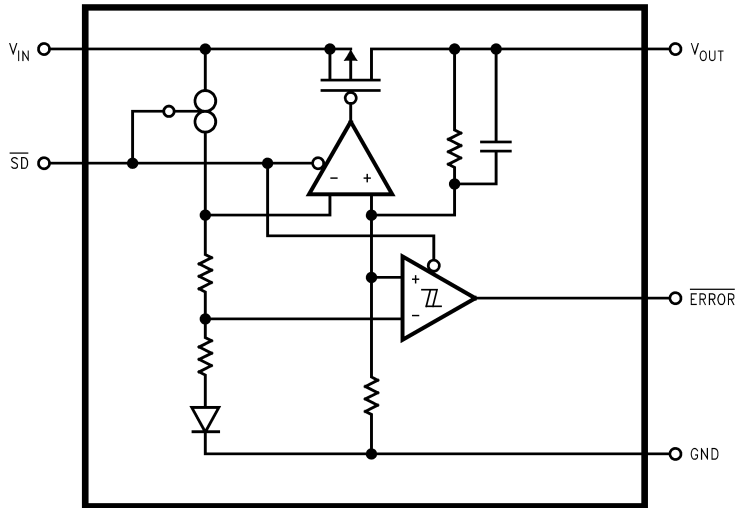

DS101267-3

### Block Diagram LP3966

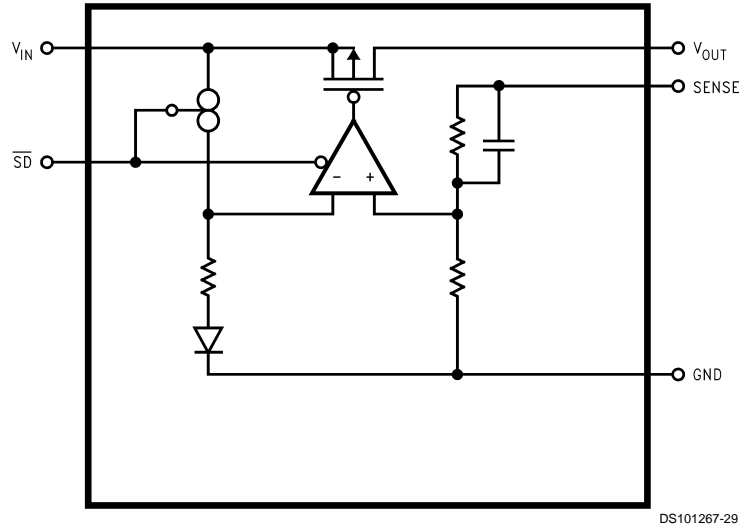

### Block Diagram LP3966-ADJ

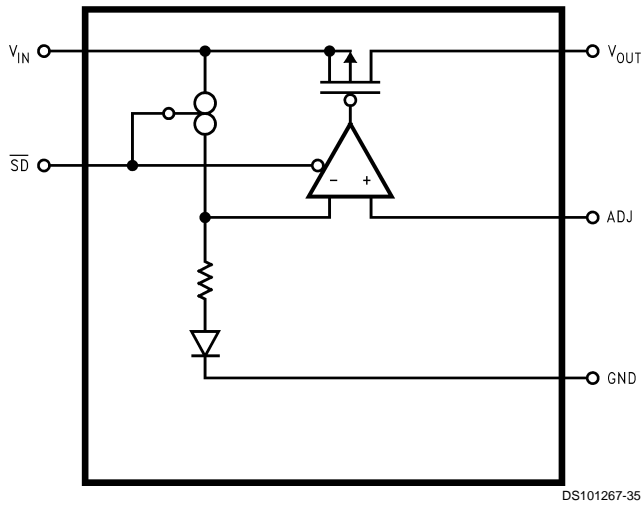

### Connection Diagrams

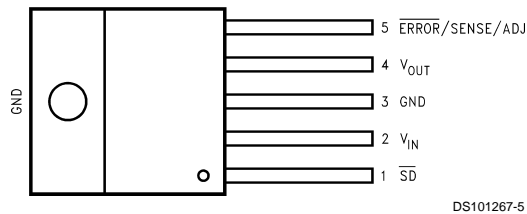

**Top View  
TO220-5 Package  
Bent, Staggered Leads**

## Connection Diagrams (Continued)

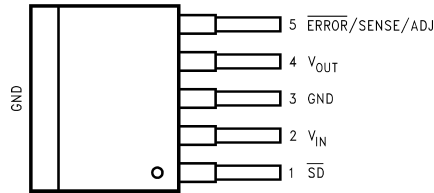

DS101267-6

**Top View  
TO263-5 Package**

## Pin Description for TO220-5 and TO263-5 Packages

Pin #	LP3963		LP3966	
	Name	Function	Name	Function
1	$\overline{SD}$	Shutdown	$\overline{SD}$	Shutdown
2	$V_{IN}$	Input Supply	$V_{IN}$	Input Supply
3	GND	Ground	GND	Ground
4	$V_{OUT}$	Output Voltage	$V_{OUT}$	Output Voltage
5	$\overline{ERROR}$	$\overline{ERROR}$ Flag	SENSE/ADJ	Remote Sense Pin/Output Adjust Pin

## Ordering Information

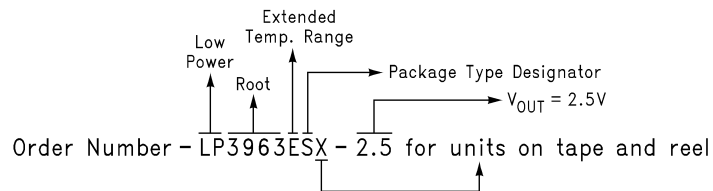
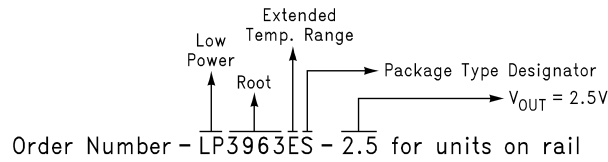

DS101267-31

Package Type Designator is "T" for TO220 package, and "S" for TO263 package.

## Ordering Information (Continued)

TABLE 1. Package Marking and Ordering Information

Output Voltage	Order Number	Description (Current, Option)	Package Type	Package Marking	Supplied As:
5.0	LP3963ES-5.0	3A, $\overline{\text{Error}}$ Flag	TO263-5	LP3963ES-5.0	Rail
5.0	LP3963ESX-5.0	3A, $\overline{\text{Error}}$ Flag	TO263-5	LP3963ESX-5.0	Tape and Reel
3.3	LP3963ES-3.3	3A, $\overline{\text{Error}}$ Flag	TO263-5	LP3963ES-3.3	Rail
3.3	LP3963ESX-3.3	3A, $\overline{\text{Error}}$ Flag	TO263-5	LP3963ES-3.3	Tape and Reel
2.5	LP3963ES-2.5	3A, $\overline{\text{Error}}$ Flag	TO263-5	LP3963ES-2.5	Rail
2.5	LP3963ESX-2.5	3A, $\overline{\text{Error}}$ Flag	TO263-5	LP3963ES-2.5	Tape and Reel
1.8	LP3963ES-1.8	3A, $\overline{\text{Error}}$ Flag	TO263-5	LP3963ES-1.8	Rail
1.8	LP3963ESX-1.8	3A, $\overline{\text{Error}}$ Flag	TO263-5	LP3963ES-1.8	Tape and Reel
5.0	LP3966ES-5.0	3A, SENSE	TO263-5	LP3966ES-5.0	Rail
5.0	LP3966ESX-5.0	3A, SENSE	TO263-5	LP3966ESX-5.0	Tape and Reel
3.3	LP3966ES-3.3	3A, SENSE	TO263-5	LP3966ES-3.3	Rail
3.3	LP3966ESX-3.3	3A, SENSE	TO263-5	LP3966ES-3.3	Tape and Reel
2.5	LP3966ES-2.5	3A, SENSE	TO263-5	LP3966ES-2.5	Rail
2.5	LP3966ESX-2.5	3A, SENSE	TO263-5	LP3966ES-2.5	Tape and Reel
1.8	LP3966ES-1.8	3A, SENSE	TO263-5	LP3966ES-1.8	Rail
1.8	LP3966ESX-1.8	3A, SENSE	TO263-5	LP3966ES-1.8	Tape and Reel
ADJ	LP3966ES-ADJ	3A, ADJ	TO263-5	LP3966ES-ADJ	Rail
ADJ	LP3966ESX-ADJ	3A, ADJ	TO263-5	LP3966ES-ADJ	Tape and Reel
5.0	LP3963ET-5.0	3A, $\overline{\text{Error}}$ Flag	TO220-5	LP3963ET-5.0	Rail
3.3	LP3963ET-3.3	3A, $\overline{\text{Error}}$ Flag	TO220-5	LP3963ET-3.3	Rail
2.5	LP3963ET-2.5	3A, $\overline{\text{Error}}$ Flag	TO220-5	LP3963ET-2.5	Rail
1.8	LP3963ET-1.8	3A, $\overline{\text{Error}}$ Flag	TO220-5	LP3963ET-1.8	Rail
5.0	LP3966ET-5.0	3A, SENSE	TO220-5	LP3966ET-5.0	Rail
3.3	LP3966ET-3.3	3A, SENSE	TO220-5	LP3966ET-3.3	Rail
2.5	LP3966ET-2.5	3A, SENSE	TO220-5	LP3966ET-2.5	Rail
1.8	LP3966ET-1.8	3A, SENSE	TO220-5	LP3966ET-1.8	Rail
ADJ	LP3966ET-ADJ	3A, ADJ	TO220-5	LP3966ET-ADJ	Rail

**Absolute Maximum Ratings** (Note 1)

If Military/Aerospace specified devices are required, please contact the National Semiconductor Sales Office/Distributors for availability and specifications.

Storage Temperature Range	-65°C to +150°C
Lead Temperature (Soldering, 5 sec.)	260°C
ESD Rating (Note 3)	2 kV
Power Dissipation (Note 2)	Internally Limited
Input Supply Voltage (Survival)	-0.3V to +7.5V
Shutdown Input Voltage (Survival)	-0.3V to $V_{IN}+0.3V$
Output Voltage (Survival), (Note 6), (Note 7)	-0.3V to +7.5V

 $I_{OUT}$  (Survival)Maximum Voltage for  $\overline{ERROR}$  Pin

Maximum Voltage for SENSE Pin

Short Circuit Protected

 $V_{IN}+0.3V$  $V_{OUT}+0.3V$ **Operating Ratings**

Input Supply Voltage (Operating)	2.5V to 7.0V
Shutdown Input Voltage (Operating)	-0.3V to $V_{IN}+0.3V$
Maximum Operating Current (DC)	3A
Operating Junction Temp. Range	-40°C to +125°C

**Electrical Characteristics**  
**LP3963/LP3966**

Limits in standard typeface are for  $T_J = 25^\circ\text{C}$ , and limits in **boldface type** apply over the **full operating temperature range**. Unless otherwise specified:  $V_{IN} = V_{O(NOM)} + 1.5V$ ,  $I_L = 10\text{ mA}$ ,  $C_{OUT} = 10\mu\text{F}$ ,  $V_{SD} = V_{IN}-0.3V$ .

Symbol	Parameter	Conditions	Typ(Note 4)	LP3963/6 (Note 5)		Units
				Min	Max	
$V_O$	Output Voltage Tolerance (Note 8)	$V_{OUT} + 1.5V < V_{IN} < 7.0V$ $10\text{ mA} < I_L < 3A$	0	-1.5 <b>-3.0</b>	+1.5 <b>+3.0</b>	%
$\Delta V_{OL}$	Output Voltage Line Regulation (Note 8)	$V_{OUT} + 1.5V < V_{IN} < 7.0V$ ,	0.02 <b>0.06</b>			%
$\frac{\Delta V_O}{\Delta I_{OUT}}$	Output Voltage Load Regulation (Note 8)	$10\text{ mA} < I_L < 3A$	0.06 <b>0.01</b>			%
$V_{IN} - V_{OUT}$	Dropout Voltage (Note 10)	$I_L = 300\text{ mA}$	80		100 <b>120</b>	mV
		$I_L = 3A$	800		1000 <b>1200</b>	
$I_{GND}$	Ground Pin Current In Normal Operation Mode	$I_L = 300\text{ mA}$	5		9 <b>10</b>	mA
		$I_L = 3A$	6		14 <b>15</b>	
$I_{GND}$	Ground Pin Current In Shutdown Mode (Note 11)	$V_{SD} \leq 0.2V$	15		25 <b>75</b>	$\mu\text{A}$
$I_{O(PK)}$	Peak Output Current	(Note 2)	4.5	4 <b>3.5</b>		A
<b>SHORT CIRCUIT PROTECTION</b>						
$I_{SC}$	Short Circuit Current		5.5			A
<b>OVER TEMPERATURE PROTECTION</b>						
Tsh(t)	Shutdown Threshold		165			°C
Tsh(h)	Thermal Shutdown Hysteresis		10			°C
<b>SHUTDOWN INPUT</b>						
$V_{SDT}$	Shutdown Threshold	Output = High	$V_{IN}$	$V_{IN}-0.3$		V
		Output = Low	0		<b>0.2</b>	
$T_{dOFF}$	Turn-off delay	$I_L = 3A$	20			$\mu\text{s}$
$T_{dON}$	Turn-on delay	$I_L = 3A$	25			$\mu\text{s}$
$I_{SD}$	$\overline{SD}$ Input Current	$V_{SD} = V_{IN}$	1			nA
$V_T$	Threshold	(Note 9)	10	<b>5</b>	<b>16</b>	%
$V_{TH}$	Threshold Hysteresis	(Note 9)	5	<b>2</b>	<b>8</b>	%

## Electrical Characteristics

### LP3963/LP3966 (Continued)

Limits in standard typeface are for  $T_J = 25^\circ\text{C}$ , and limits in **boldface type** apply over the **full operating temperature range**. Unless otherwise specified:  $V_{IN} = V_{O(NOM)} + 1.5\text{V}$ ,  $I_L = 10\text{ mA}$ ,  $C_{OUT} = 10\mu\text{F}$ ,  $V_{SD} = V_{IN} - 0.3\text{V}$ .

Symbol	Parameter	Conditions	Typ(Note 4)	LP3963/6 (Note 5)		Units
				Min	Max	
<b>SHUTDOWN INPUT</b>						
$V_{EF(\text{Sat})}$	Error Flag Saturation	$I_{\text{sink}} = 100\mu\text{A}$	0.02		<b>0.1</b>	V
$T_d$	Flag Reset Delay		1			$\mu\text{s}$
$I_{lk}$	Error Flag Pin Leakage Current		1			nA
$I_{\text{max}}$	Error Flag Pin Sink Current	$V_{\text{Error}} = \mathbf{0.5V}$	1			mA
<b>AC PARAMETERS</b>						
PSRR	Ripple Rejection	$V_{IN} = V_{OUT} + 1.5\text{V}$ $C_{OUT} = 100\mu\text{F}$ $V_{OUT} = 3.3\text{V}$	60			dB
		$V_{IN} = V_{OUT} + 0.3\text{V}$ $C_{OUT} = 100\mu\text{F}$ $V_{OUT} = 3.3\text{V}$	40			
$\rho_{n(f)}$	Output Noise Density	$f = 120\text{Hz}$	0.8			$\mu\text{V}$
$e_n$	Output Noise Voltage (rms)	$\text{BW} = 10\text{Hz} - 100\text{kHz}$	150			$\mu\text{V}$
		$\text{BW} = 300\text{Hz} - 300\text{kHz}$	100			(rms)

**Note 1:** Absolute maximum ratings indicate limits beyond which damage to the device may occur. Operating ratings indicate conditions for which the device is intended to be functional, but does not guarantee specific performance limits. For guaranteed specifications and test conditions, see Electrical Characteristics. The guaranteed specifications apply only for the test conditions listed. Some performance characteristics may degrade when the device is not operated under the listed test conditions.

**Note 2:** At elevated temperatures, devices must be derated based on package thermal resistance. The devices in TO220 package must be derated at  $\theta_{JA} = 50^\circ\text{C/W}$  (with  $0.5\text{in}^2$ , 1oz. copper area), junction-to-ambient (with no heat sink). The devices in the TO263 surface-mount package must be derated at  $\theta_{JA} = 60^\circ\text{C/W}$  (with  $0.5\text{in}^2$ , 1oz. copper area), junction-to-ambient.

**Note 3:** The human body model is a  $100\text{pF}$  capacitor discharged through a  $1.5\text{k}\Omega$  resistor into each pin.

**Note 4:** Typical numbers are at  $25^\circ\text{C}$  and represent the most likely parametric norm.

**Note 5:** Limits are 100% production tested at  $25^\circ\text{C}$ . Limits over the operating temperature range are guaranteed through correlation using Statistical Quality Control (SQC) methods. The limits are used to calculate National's Average Outgoing Quality Level (AOQL).

**Note 6:** If used in a dual-supply system where the regulator load is returned to a negative supply, the LP396X output must be diode-clamped to ground.

**Note 7:** The output PMOS structure contains a diode between the  $V_{IN}$  and  $V_{OUT}$  terminals. This diode is normally reverse biased. This diode will get forward biased if the voltage at the output terminal is forced to be higher than the voltage at the input terminal. This diode can typically withstand  $200\text{mA}$  of DC current and  $1\text{Amp}$  of peak current.

**Note 8:** Output voltage line regulation is defined as the change in output voltage from the nominal value due to change in the input line voltage. Output voltage load regulation is defined as the change in output voltage from the nominal value due to change in load current. The line and load regulation specification contains only the typical number. However, the limits for line and load regulation are included in the output voltage tolerance specification.

**Note 9:** Error Flag threshold and hysteresis are specified as percentage of regulated output voltage.

**Note 10:** Dropout voltage is defined as the minimum input to output differential voltage at which the output drops 2% below the nominal value. Dropout voltage specification applies only to output voltages of  $2.5\text{V}$  and above. For output voltages below  $2.5\text{V}$ , the drop-out voltage is nothing but the input to output differential, since the minimum input voltage is  $2.5\text{V}$ .

**Note 11:** This specification has been tested for  $-40^\circ\text{C} \leq T_J \leq 85^\circ\text{C}$  since the temperature rise of the device is negligible under shutdown conditions.

**Typical Performance Characteristics** Unless otherwise specified,  $V_{IN} = V_{O(NOM)} + 1.5V$ ,  $V_{OUT} = 2.5V$ ,  $C_{OUT} = 10\mu F$ ,  $I_{OUT} = 10mA$ ,  $C_{IN} = 10\mu F$ ,  $V_{SD} = V_{IN}$ , and  $T_A = 25^\circ C$ .

**Drop-Out Voltage Vs Temperature for Different Load Currents**

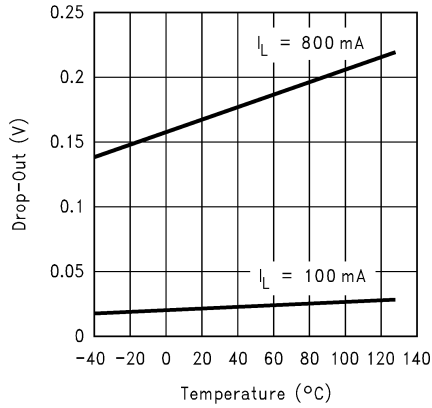

**Drop-Out Voltage Vs Temperature for Different Output Voltages ( $I_{OUT} = 800mA$ )**

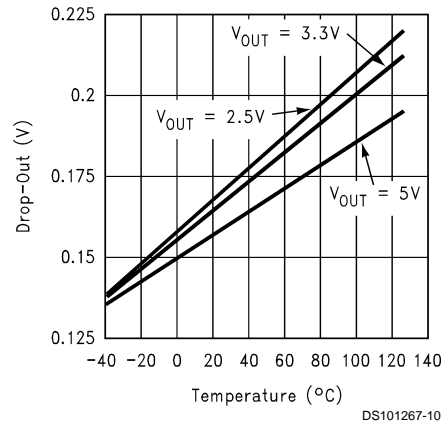

**Ground Pin Current Vs Input Voltage ( $V_{SD}=V_{IN}$ )**

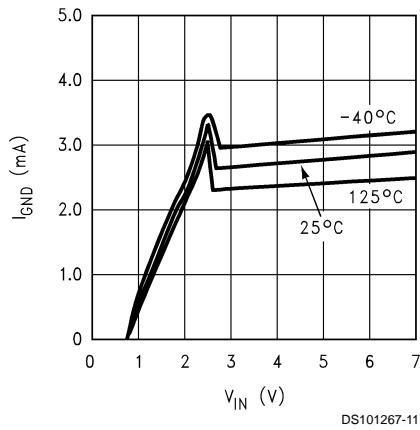

**Ground Pin Current Vs Input Voltage ( $V_{SD}=100mV$ )**

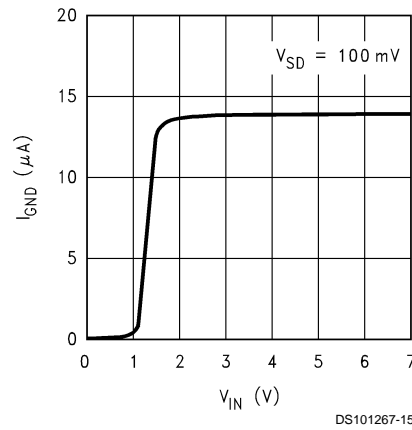

**Ground Current Vs Temperature ( $V_{SD}=V_{IN}$ )**

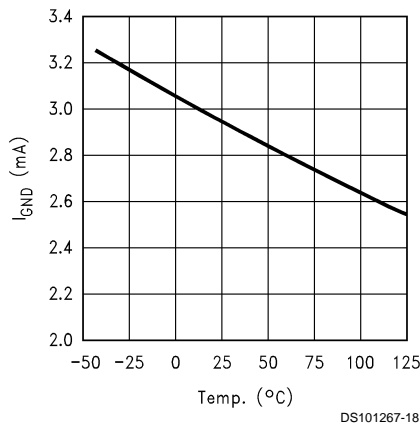

**Ground Current Vs Temperature ( $V_{SD}=0V$ )**

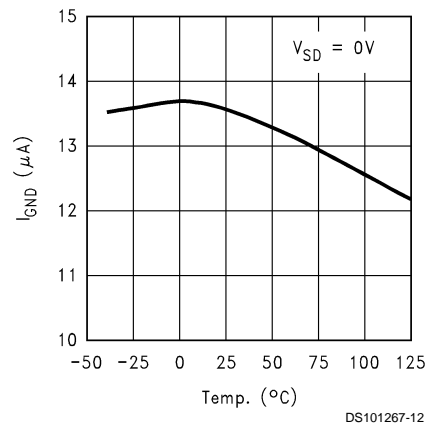



**Typical Performance Characteristics** Unless otherwise specified,  $V_{IN} = V_{O(NOM)} + 1.5V$ ,  $V_{OUT} = 2.5V$ ,  $C_{OUT} = 10\mu F$ ,  $I_{OUT} = 10mA$ ,  $C_{IN} = 10\mu F$ ,  $V_{SD} = V_{IN}$ , and  $T_A = 25^\circ C$ . (Continued)

**Ground Pin Current Vs Shutdown Pin Voltage**

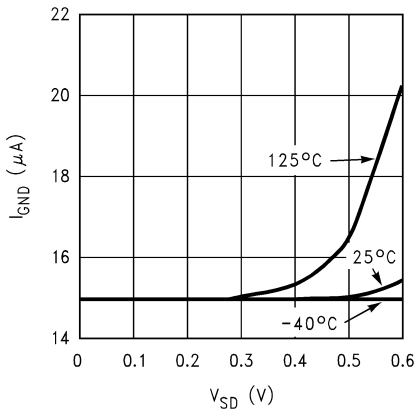

DS101267-16

**Input Voltage Vs Output Voltage**

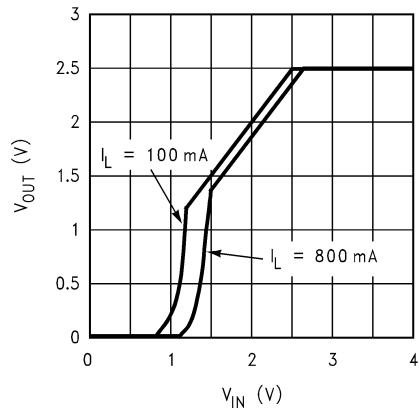

DS101267-17

**Output Noise Density,  $V_{OUT} = 2.5V$**

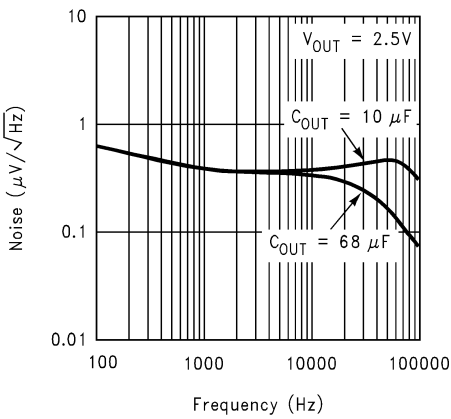

DS101267-13

**Output Noise Density,  $V_{OUT} = 5V$**

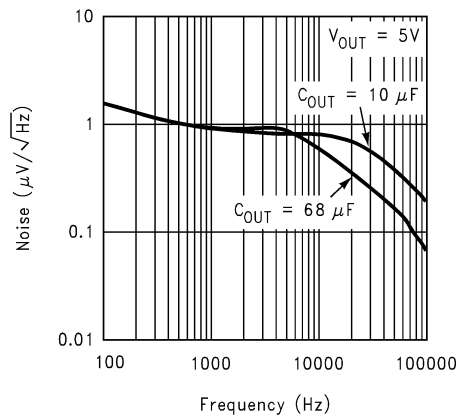

DS101267-14

## Applications Information

### Input Capacitor Selection

The LP3963 and LP3966 require a minimum input capacitance of 10 $\mu$ F between the input and ground pins to prevent any impedance interactions with the supply. This capacitor should be located very close to the  $V_{IN}$  pin. This capacitor can be of any type such as ceramic, tantalum, or low ESR aluminium. Any good quality capacitor which has good tolerance over temperature and frequency is recommended.

### Output Capacitor Selection

The LP3963 and LP3966 require a minimum of 10 $\mu$ F capacitance between the output and ground pins for proper operation. LP3963 and LP3966 work best with Tantalum or Electrolytic capacitor. The output capacitor should have a good tolerance over temperature, voltage, and frequency. Larger capacitance provides better improved load dynamics and noise performance. The output capacitor should be connected very close to the  $V_{out}$  pin.

### Output Adjustment

An adjustable output device has output voltage range of 1.215V to 5.1V. To obtain a desired output voltage, the following equation can be used with  $R_1$  always a 10k $\Omega$  resistor.

$$R_2 = R_1 \left( \frac{V_{OUT}}{1.215} - 1 \right)$$

For output stability,  $C_F$  must be between 68pF and 100pF.

### Output Noise

Noise is specified in two ways-

**Spot Noise** or **Output noise density** is the RMS sum of all noise sources, measured at the regulator output, at a specific frequency (measured with a 1Hz bandwidth). This type of noise is usually plotted on a curve as a function of frequency.

**Total output Noise** or **Broad-band noise** is the RMS sum of spot noise over a specified bandwidth, usually several decades of frequencies.

Attention should be paid to the units of measurement. Spot noise is measured in units  $\mu$ V/ $\sqrt{\text{Hz}}$  or nV/ $\sqrt{\text{Hz}}$  and total output noise is measured in  $\mu$ V(rms).

The primary source of noise in low-dropout regulators is the internal reference. In CMOS regulators, noise has a low fre-

quency component and a high frequency component, which depend strongly on the silicon area and quiescent current. Noise can be reduced in two ways: by increasing the transistor area or by increasing the current drawn by the internal reference. Increasing the area will decrease the chance of fitting the die into a smaller package. Increasing the current drawn by the internal reference increases the total supply current (ground pin current). Using an optimized trade-off of ground pin current and die size, LP3963/LP3966 achieves low noise performance and low quiescent current operation.

The total output noise specification for LP3963/LP3966 is presented in the Electrical Characteristics table. The Output noise density at different frequencies is represented by a curve under typical performance characteristics.

### Short-Circuit Protection

The LP3963 and LP3966 is short circuit protected and in the event of a peak over-current condition, the short-circuit control loop will rapidly drive the output PMOS pass element off. Once the power pass element shuts down, the control loop will rapidly cycle the output on and off until the average power dissipation causes the thermal shutdown circuit to respond to servo the on/off cycling to a lower frequency. Please refer to the section on thermal information for power dissipation calculations.

### Error Flag Operation

The LP3963/LP3966 produces a logic low signal at the  $\overline{\text{Error}}$  Flag pin when the output drops out of regulation due to low input voltage, current limiting, or thermal limiting. This flag has a built in hysteresis. The timing diagram in *Figure 1* shows the relationship between the  $\overline{\text{ERROR}}$  and the output voltage. In this example, the input voltage is changed to demonstrate the functionality of the Error Flag.

The internal  $\overline{\text{Error}}$  flag comparator has an open drain output stage. Hence, the  $\overline{\text{ERROR}}$  pin should be pulled high through a pull up resistor. Although the  $\overline{\text{ERROR}}$  pin can sink current of 1mA, this current is energy drain from the input supply. Hence, the value of the pull up resistor should be in the range of 10k $\Omega$  to 1M $\Omega$ . **The  $\overline{\text{ERROR}}$  pin must be connected to ground if this function is not used.** It should also be noted that when the shutdown pin is pulled low, the  $\overline{\text{ERROR}}$  pin is forced to be invalid for reasons of saving power in shutdown mode.

Applications Information (Continued)

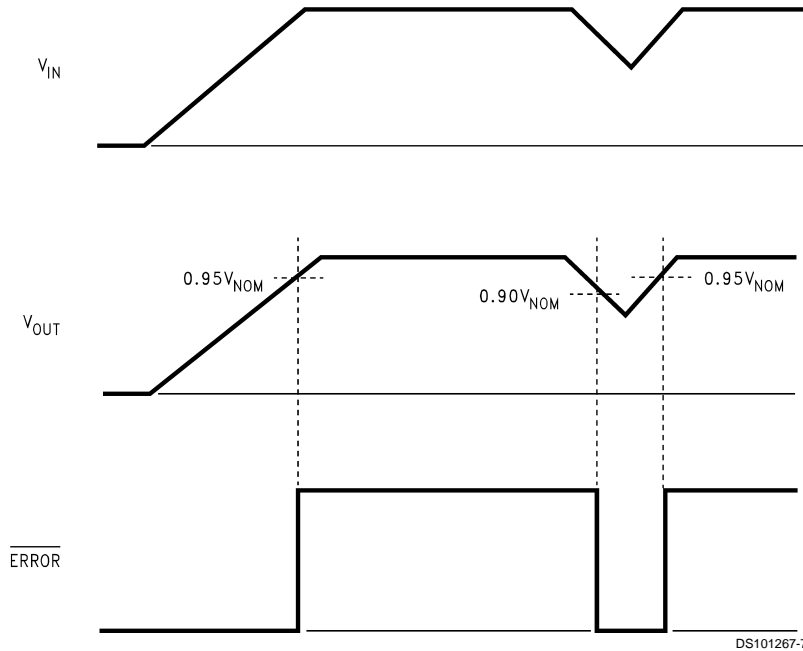

FIGURE 1.  $\overline{ERROR}$  Flag Operation

Sense Pin

In applications where the regulator output is not very close to the load, LP3966 can provide better remote load regulation using the SENSE pin. Figure 2 depicts the advantage of the SENSE option. LP3963 regulates the voltage at the output pin. Hence, the voltage at the remote load will be the regulator output voltage minus the drop across the trace resis-

tance. For example, in the case of a 3.3V output, if the trace resistance is  $100m\Omega$ , the voltage at the remote load will be 3V with 3A of load current,  $I_{LOAD}$ . The LP3966 regulates the voltage at the sense pin. Connecting the sense pin to the remote load will provide regulation at the remote load, as shown in Figure 2. If the sense option pin is not required, the sense pin must be connected to the  $V_{OUT}$  pin.

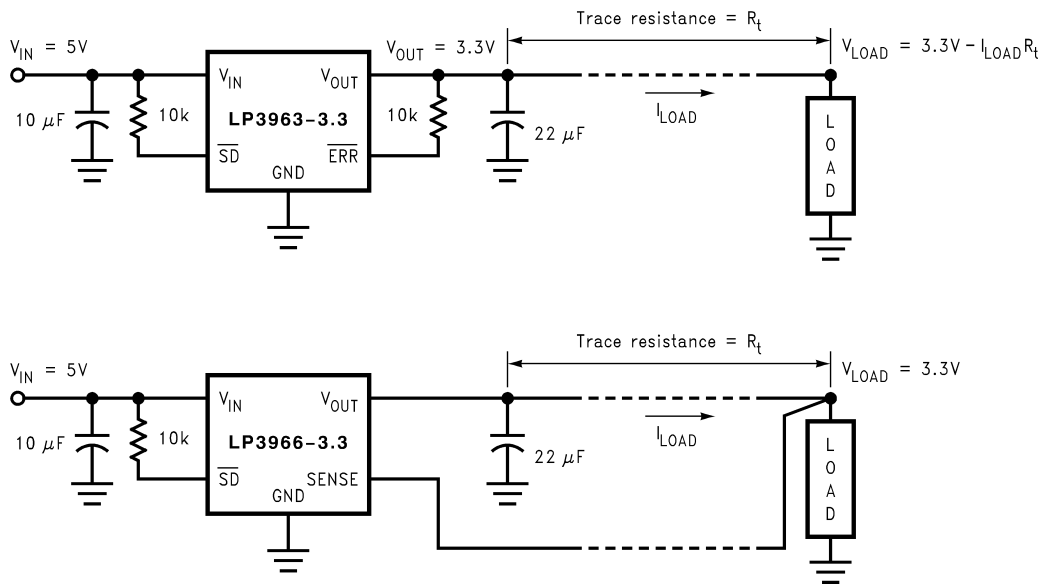

FIGURE 2. Improving remote load regulation using LP3966

## Applications Information (Continued)

### Shutdown Operation

A CMOS Logic level signal at the shutdown ( $\overline{SD}$ ) pin will turn-off the regulator. Pin  $\overline{SD}$  must be actively terminated through a 10k $\Omega$  pull-up resistor for a proper operation. If this pin is driven from a source that actively pulls high and low (such as a CMOS rail to rail comparator), the pull-up resistor is not required. This pin must be tied to  $V_{in}$  if not used.

### Dropout Voltage

The dropout voltage of a regulator is defined as the minimum input-to-output differential required to stay within 2% of the output voltage. The LP3963/LP3966 use an internal MOSFET with an  $R_{ds(on)}$  of 240m $\Omega$  (typically). For CMOS LDOs, the dropout voltage is the product of the load current and the  $R_{ds(on)}$  of the internal MOSFET.

### Reverse Current Path

The internal MOSFET in LP3963 and LP3966 has an inherent parasitic diode. During normal operation, the input voltage is higher than the output voltage and the parasitic diode is reverse biased. However, if the output is pulled above the input in an application, then current flows from the output to the input as the parasitic diode gets forward biased. The output can be pulled above the input as long as the current in the parasitic diode is limited to 200mA continuous and 1A peak.

### Maximum Output Current Capability

LP3963 and LP3966 can deliver a continuous current of 3A over the full operating temperature range. A heatsink may be required depending on the maximum power dissipation and maximum ambient temperature of the application. Under all possible conditions, the junction temperature must be within the range specified under operating conditions. The total power dissipation of the device is given by:

$$P_D = (V_{IN} - V_{OUT})I_{OUT} + (V_{IN})I_{GND}$$

where  $I_{GND}$  is the operating ground current of the device (specified under Electrical Characteristics).

The maximum allowable temperature rise ( $T_{Rmax}$ ) depends on the maximum ambient temperature ( $T_{Amax}$ ) of the application, and the maximum allowable junction temperature ( $T_{Jmax}$ ):

$$T_{Rmax} = T_{Jmax} - T_{Amax}$$

The maximum allowable value for junction to ambient Thermal Resistance,  $\theta_{JA}$ , can be calculated using the formula:

$$\theta_{JA} = T_{Rmax} / P_D$$

LP3963 and LP3966 are available in TO-220 and TO-263 packages. The thermal resistance depends on amount of copper area or heat sink, and on air flow. If the maximum allowable value of  $\theta_{JA}$  calculated above is  $\geq 60$   $^{\circ}\text{C}/\text{W}$  for TO-220 package and  $\geq 60$   $^{\circ}\text{C}/\text{W}$  for TO-263 package no heatsink is needed since the package can dissipate enough heat to satisfy these requirements. If the value for allowable  $\theta_{JA}$  falls below these limits, a heat sink is required.

### Heatsinking TO-220 Package

The thermal resistance of a TO220 package can be reduced by attaching it to a heat sink or a copper plane on a PC board. If a copper plane is to be used, the values of  $\theta_{JA}$  will be same as shown in next section for TO263 package.

The heatsink to be used in the application should have a heatsink to ambient thermal resistance,

$$\theta_{HA} \leq \theta_{JA} - \theta_{CH} - \theta_{JC}$$

In this equation,  $\theta_{CH}$  is the thermal resistance from the junction to the surface of the heat sink and  $\theta_{JC}$  is the thermal resistance from the junction to the surface of the case.  $\theta_{JC}$  is about 3 $^{\circ}\text{C}/\text{W}$  for a TO220 package. The value for  $\theta_{CH}$  depends on method of attachment, insulator, etc.  $\theta_{CH}$  varies between 1.5 $^{\circ}\text{C}/\text{W}$  to 2.5 $^{\circ}\text{C}/\text{W}$ . If the exact value is unknown, 2 $^{\circ}\text{C}/\text{W}$  can be assumed.

### Heatsinking TO-263 Package

The TO-263 package uses the copper plane on the PCB as a heatsink. The tab of these packages are soldered to the copper plane for heat sinking. Figure 3 shows a curve for the  $\theta_{JA}$  of TO-263 package for different copper area sizes, using a typical PCB with 1 ounce copper and no solder mask over the copper area for heat sinking.

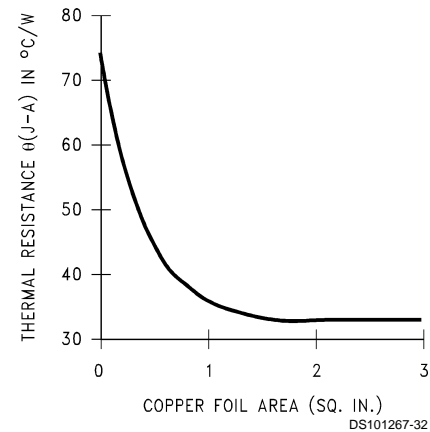

FIGURE 3.  $\theta_{JA}$  vs Copper(1 Ounce) Area for TO-263 package

As shown in the figure, increasing the copper area beyond 1 square inch produces very little improvement. The minimum value for  $\theta_{JA}$  for the TO-263 package mounted to a PCB is 32 $^{\circ}\text{C}/\text{W}$ .

Figure 4 shows the maximum allowable power dissipation for TO-263 packages for different ambient temperatures, assuming  $\theta_{JA}$  is 35 $^{\circ}\text{C}/\text{W}$  and the maximum junction temperature is 125 $^{\circ}\text{C}$ .

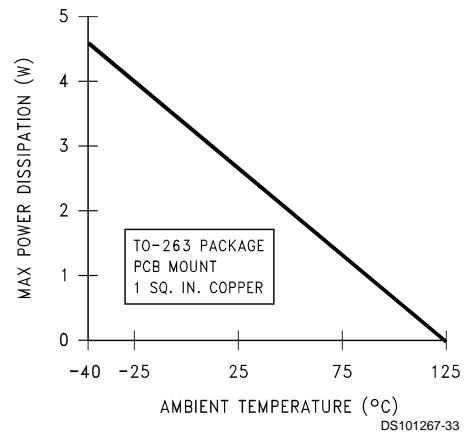
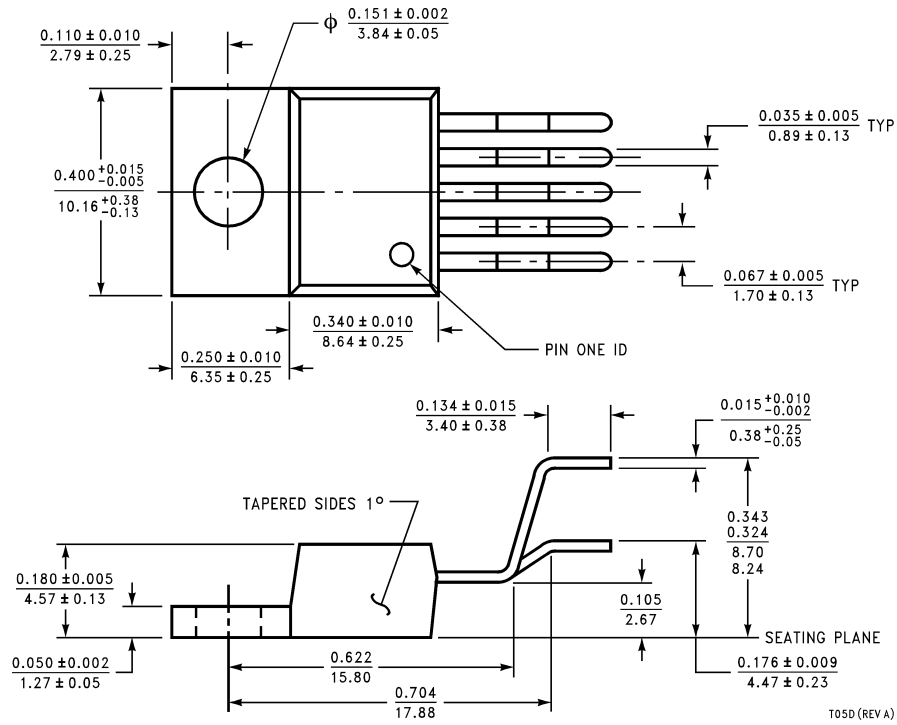

FIGURE 4. Maximum power dissipation vs ambient temperature for TO-263 package

**Physical Dimensions** inches (millimeters) unless otherwise noted



**TO220 5-lead, Molded, Stagger Bend Package (TO220-5)**

**NS Package Number T05D**

For Order Numbers, refer to the "Ordering Information" section of this document.

**Physical Dimensions** inches (millimeters) unless otherwise noted (Continued)

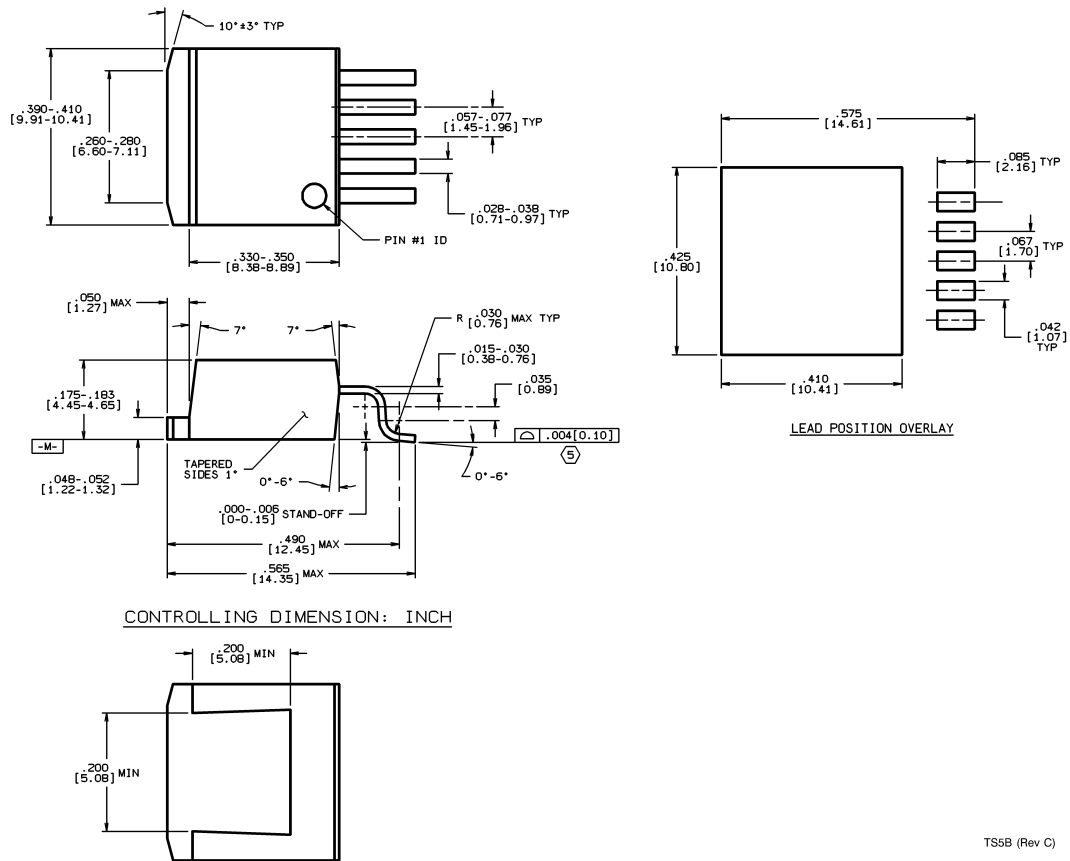

**TO263 5-Lead, Molded, Surface Mount Package (TO263-5)  
NS Package Number TS5B**

For Order Numbers, refer to the "Ordering Information" section of this document.

TS5B (Rev C)

**LIFE SUPPORT POLICY**

NATIONAL'S PRODUCTS ARE NOT AUTHORIZED FOR USE AS CRITICAL COMPONENTS IN LIFE SUPPORT DEVICES OR SYSTEMS WITHOUT THE EXPRESS WRITTEN APPROVAL OF THE PRESIDENT AND GENERAL COUNSEL OF NATIONAL SEMICONDUCTOR CORPORATION. As used herein:

1. Life support devices or systems are devices or systems which, (a) are intended for surgical implant into the body, or (b) support or sustain life, and whose failure to perform when properly used in accordance with instructions for use provided in the labeling, can be reasonably expected to result in a significant injury to the user.
2. A critical component is any component of a life support device or system whose failure to perform can be reasonably expected to cause the failure of the life support device or system, or to affect its safety or effectiveness.

 **National Semiconductor Corporation**  
Americas  
Tel: 1-800-272-9959  
Fax: 1-800-737-7018  
Email: support@nsc.com  
www.national.com

**National Semiconductor Europe**  
Fax: +49 (0) 180-530 85 86  
Email: europe.support@nsc.com  
Deutsch Tel: +49 (0) 69 9508 6208  
English Tel: +44 (0) 870 24 0 2171  
Français Tel: +33 (0) 1 41 91 8790

**National Semiconductor Asia Pacific Customer Response Group**  
Tel: 65-2544466  
Fax: 65-2504466  
Email: ap.support@nsc.com

**National Semiconductor Japan Ltd.**  
Tel: 81-3-5639-7560  
Fax: 81-3-5639-7507