

LMV341/LMV342/LMV344

Single with Shutdown/Dual/Quad General Purpose, 2.7V, Rail-to-Rail Output, 125°C, Operational Amplifiers

General Description

The LMV341/342/344 are single, dual, and quad low voltage, and low power Operational Amplifiers. They are designed specifically for low voltage portable applications. Other important product characteristics are low input bias current, rail-to-rail output, and wide temperature range.

The patented class AB turnaround stage significantly reduces the noise at higher frequencies, power consumption, and offset voltage. The PMOS input stage provides the user with ultra-low input bias current of 20fA (typical) and high input impedance.

The industrial-plus temperature range of -40°C to 125°C allows the LMV341/342/344 to accommodate a broad range of extended environment applications. LMV341 expands National Semiconductor's Silicon Dust™ amplifier portfolio offering enhancements in size, speed, and power savings. The LMV341/342/344 are guaranteed to operate over the voltage range of 2.7V to 5.0V and all have rail-to-rail output.

The LMV341 offers a shutdown pin that can be used to disable the device. Once in shutdown mode, the supply current is reduced to 45pA (typical). The LMV341/342/344 have 29nV Voltage Noise at 10KHz, 1MHz GBW, 1.0V/μs Slew Rate, 0.25mVos, and 0.1μA shutdown current (LMV341.)

The LMV341 is offered in the tiny SC70-6L package, the LMV342 in space saving MSOP-8 and SOIC-8, and the LMV344 in TSSOP-14 and SOIC-14. These small package amplifiers offer an ideal solution for applications requiring

minimum PC board footprint. Applications with area constrained PC board requirements include portable electronics such as cellular handsets and PDAs.

Features

(Typical 2.7V Supply Values; Unless Otherwise Noted)

■ Guaranteed 2.7V and 5V specifications	
■ Input referred voltage noise (@10kHz)	29nV/√Hz
■ Supply current (per amplifier)	100μA
■ Gain bandwidth product	1.0MHz
■ Slew rate	1.0V/μs
■ Shutdown Current (LMV341)	45pA
■ Turn-on time from shutdown (LMV341)	5μs
■ Input bias current	20fA

Applications

- Cordless/cellular phones
- Laptops
- PDAs
- PCMCIA/Audio
- Portable/battery-powered electronic equipment
- Supply current monitoring
- Battery monitoring
- Buffer
- Filter
- Driver

Connection Diagram

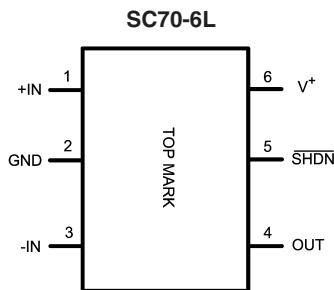

20030441

Top View

Order Number

LMV341MG, LMV341MGX
 LMV342MM, LMV342MMX
 LMV342MA, LMV342MAX
 LMV344MT, LMV344MTX
 LMV344MA, LMV344MAX

Sample and Hold Circuit

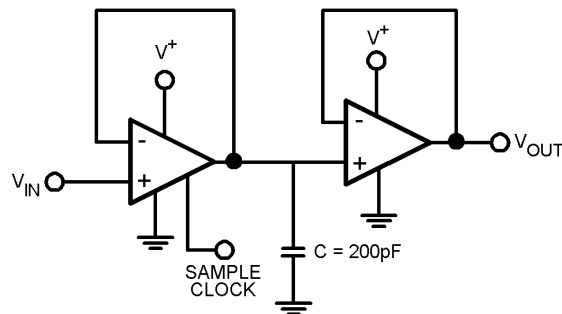

20030444

Absolute Maximum Ratings (Note 1)

If Military/Aerospace specified devices are required, please contact the National Semiconductor Sales Office/Distributors for availability and specifications.

ESD Tolerance (Note 2)

Machine Model	200V
Human Body Model	2000V
Differential Input Voltage	± Supply Voltage
Supply Voltage (V^+ - V^-)	5.5V
Output Short Circuit to V^+	(Note 3)
Output Short Circuit to V^-	(Note 4)
Storage Temperature Range	-65°C to 150°C
Junction Temperature (Note 5)	150°C
Mounting Temperature	

Infrared or Convection Reflow

(20 sec.)

235°C

Wave Soldering Lead Temp.

(10 sec.)

260°C

Operating Ratings (Note 1)

Temperature Range	-40°C to 125°C
Thermal Resistance (θ_{JA})	
6-Pin SC70	414°C/W
8-Pin SOIC	190°C/W
8-Pin MSOP	235°C/W
14-Pin TSSOP	155°C/W
14-Pin SOIC	145°C/W

2.7V DC Electrical Characteristics (Note 10)

Unless otherwise specified, all limits guaranteed for $T_J = 25^\circ\text{C}$, $V^+ = 2.7\text{V}$, $V^- = 0\text{V}$, $V_{CM} = V^+/2$, $V_O = V^+/2$ and $R_L > 1\text{M}\Omega$.

Boldface limits apply at the temperature extremes.

Symbol	Parameter	Conditions	Min (Note 7)	Typ (Note 6)	Max (Note 7)	Units
V_{OS}	Input Offset Voltage	LMV341		0.25	4 4.5	mV
		LMV342/LMV344		0.55	5 5.5	
TCV_{OS}	Input Offset Voltage Average Drift			1.7		$\mu\text{V}/^\circ\text{C}$
I_B	Input Bias Current			0.02	120 250	pA
I_{OS}	Input Offset Current			6.6		fA
I_S	Supply Current	Per Amplifier		100	170 230	μA
		Shutdown Mode, $V_{SD} = 0\text{V}$ (LMV341)		45pA	1 μA 1.5μA	
CMRR	Common Mode Rejection Ratio	$0\text{V} \leq V_{CM} \leq 1.7\text{V}$	56	80		dB
		$0\text{V} \leq V_{CM} \leq 1.6\text{V}$	50			
PSRR	Power Supply Rejection Ratio	$2.7\text{V} \leq V^+ \leq 5\text{V}$	65 60	82		dB
V_{CM}	Input Common Mode Voltage	For CMRR $\geq 50\text{dB}$	0	-0.2 to 1.9 (Range)	1.7	V
A_V	Large Signal Voltage Gain	$R_L = 10\text{k}\Omega$ to 1.35V	78 70	113		dB
		$R_L = 2\text{k}\Omega$ to 1.35V	72 64	103		
V_O	Output Swing	$R_L = 2\text{k}\Omega$ to 1.35V		24	60 95	mV
			60 95	26		
		$R_L = 10\text{k}\Omega$ to 1.35V		5.0	30 40	
			30 40	5.3		

2.7V DC Electrical Characteristics (Note 10) (Continued)

Unless otherwise specified, all limits guaranteed for $T_J = 25^\circ\text{C}$, $V^+ = 2.7\text{V}$, $V^- = 0\text{V}$, $V_{\text{CM}} = V^+/2$, $V_O = V^+/2$ and $R_L > 1\text{M}\Omega$.

Boldface limits apply at the temperature extremes.

Symbol	Parameter	Conditions	Min (Note 7)	Typ (Note 6)	Max (Note 7)	Units
I_O	Output Short Circuit Current	Sourcing LMV341/LMV342	20	32		mA
		Sourcing LMV344	18	24		
		Sinking	15	24		
t_{on}	Turn-on Time from Shutdown	(LMV341)		5		μs
V_{SD}	Shutdown Pin Voltage Range	ON Mode (LMV341)		1.7 to 2.7	2.4 to 2.7	V
		Shutdown Mode (LMV341)		0 to 1	0 to 0.8	

2.7V AC Electrical Characteristics (Note 10)

Unless otherwise specified, all limits guaranteed for $T_J = 25^\circ\text{C}$, $V^+ = 2.7\text{V}$, $V^- = 0\text{V}$, $V_{\text{CM}} = V^+/2$, $V_O = V^+/2$ and $R_L > 1\text{M}\Omega$.

Boldface limits apply at the temperature extremes.

Symbol	Parameter	Conditions	Min (Note 7)	Typ (Note 6)	Max (Note 7)	Units
SR	Slew Rate	$R_L = 10\text{k}\Omega$, (Note 9)		1.0		$\text{V}/\mu\text{s}$
GBW	Gain Bandwidth Product	$R_L = 100\text{k}\Omega$, $C_L = 200\text{pF}$		1.0		MHz
Φ_m	Phase Margin	$R_L = 100\text{k}\Omega$		72		deg
G_m	Gain Margin	$R_L = 100\text{k}\Omega$		20		dB
e_n	Input-Referred Voltage Noise	$f = 1\text{kHz}$		40		$\text{nV}/\sqrt{\text{Hz}}$
i_n	Input-Referred Current Noise	$f = 1\text{kHz}$		0.001		$\text{pA}/\sqrt{\text{Hz}}$
THD	Total Harmonic Distortion	$f = 1\text{kHz}$, $A_V = +1$ $R_L = 600\Omega$, $V_{\text{IN}} = 1V_{\text{PP}}$		0.017		%

5V DC Electrical Characteristics (Note 10)

Unless otherwise specified, all limits guaranteed for $T_J = 25^\circ\text{C}$, $V^+ = 5\text{V}$, $V^- = 0\text{V}$, $V_{\text{CM}} = V^+/2$, $V_O = V^+/2$ and $R_L > 1\text{M}\Omega$.

Boldface limits apply at the temperature extremes.

Symbol	Parameter	Conditions	Min (Note 7)	Typ (Note 6)	Max (Note 7)	Units
V_{OS}	Input Offset Voltage	LMV341		0.025	4 4.5	mV
		LMV342/LMV344		0.70	5 5.5	
TCV_{OS}	Input Offset Voltage Average Drift			1.9		$\mu\text{V}/^\circ\text{C}$
I_B	Input Bias Current			0.02	200 375	pA
I_{OS}	Input Offset Current			6.6		fA
I_S	Supply Current	Per Amplifier		107	200 260	μA
		Shutdown Mode, $V_{\text{SD}} = 0\text{V}$ (LMV341)		0.033	1 1.5	μA
CMRR	Common Mode Rejection Ratio	$0\text{V} \leq V_{\text{CM}} \leq 4.0\text{V}$ $0\text{V} \leq V_{\text{CM}} \leq 3.9\text{V}$	56 50	86		dB
PSRR	Power Supply Rejection Ratio	$2.7\text{V} \leq V^+ \leq 5\text{V}$	65 60	82		dB
V_{CM}	Input Common Mode Voltage	For CMRR $\geq 50\text{dB}$	0	-0.2 to 4.2 (Range)	4	V

5V DC Electrical Characteristics (Note 10) (Continued)

Unless otherwise specified, all limits guaranteed for $T_J = 25^\circ\text{C}$, $V^+ = 5\text{V}$, $V^- = 0\text{V}$, $V_{\text{CM}} = V^+/2$, $V_O = V^+/2$ and $R_L > 1\text{M}\Omega$.

Boldface limits apply at the temperature extremes.

Symbol	Parameter	Conditions	Min (Note 7)	Typ (Note 6)	Max (Note 7)	Units
A_V	Large Signal Voltage Gain (Note 8)	$R_L = 10\text{k}\Omega$ to 2.5V	78 70	116		dB
		$R_L = 2\text{k}\Omega$ to 2.5V	72 64	107		
V_O	Output Swing	$R_L = 2\text{k}\Omega$ to 2.5V		32	60 95	mV
			60 95	34		
		$R_L = 10\text{k}\Omega$ to 2.5V		7	30 40	mV
			30 40	7		
I_O	Output Short Circuit Current	Sourcing	85	113		mA
		Sinking	50	75		
t_{on}	Turn-on Time from Shutdown	(LMV341)		5		μs
V_{SD}	Shutdown Pin Voltage Range	ON Mode (LMV341)		3.1 to 5	4.5 to 5.0	V
		Shutdown Mode (LMV341)		0 to 1	0 to 0.8	

5V AC Electrical Characteristics (Note 10)

Unless otherwise specified, all limits guaranteed for $T_J = 25^\circ\text{C}$, $V^+ = 5\text{V}$, $V^- = 0\text{V}$, $V_{\text{CM}} = V^+/2$, $V_O = V^+/2$ and $R_L > 1\text{M}\Omega$.

Boldface limits apply at the temperature extremes.

Symbol	Parameter	Conditions	Min (Note 7)	Typ (Note 6)	Max (Note 7)	Units
SR	Slew Rate	$R_L = 10\text{k}\Omega$, (Note 9)		1.0		V/ μs
GBW	Gain-Bandwidth Product	$R_L = 10\text{k}\Omega$, $C_L = 200\text{pF}$		1.0		MHz
Φ_m	Phase Margin	$R_L = 100\text{k}\Omega$		70		deg
G_m	Gain Margin	$R_L = 100\text{k}\Omega$		20		dB
e_n	Input-Referred Voltage Noise	$f = 1\text{kHz}$		39		nV/ $\sqrt{\text{Hz}}$
i_n	Input-Referred Current Noise	$f = 1\text{kHz}$		0.001		pA/ $\sqrt{\text{Hz}}$
THD	Total Harmonic Distortion	$f = 1\text{kHz}$, $A_V = +1$ $R_L = 600\Omega$, $V_{\text{IN}} = 1V_{\text{PP}}$		0.012		%

Note 1: Absolute Maximum Ratings indicate limits beyond which damage to the device may occur. Operating Ratings indicate conditions for which the device is intended to be functional, but specific performance is not guaranteed. For guaranteed specifications and the test conditions, see the Electrical Characteristics.

Note 2: Human body model, 1.5k Ω in series with 100pF. Machine model, 0 Ω in series with 200pF.

Note 3: Shorting output to V^+ will adversely affect reliability.

Note 4: Shorting output to V^- will adversely affect reliability.

Note 5: The maximum power dissipation is a function of $T_{\text{J(MAX)}}$, θ_{JA} , and T_A . The maximum allowable power dissipation at any ambient temperature is $P_D = (T_{\text{J(MAX)}} - T_A) / \theta_{\text{JA}}$. All numbers apply for packages soldered directly into a PC board.

Note 6: Typical values represent the most likely parametric norm.

Note 7: All limits are guaranteed by testing or statistical analysis.

Note 8: R_L is connected to mid-supply. The output voltage is $\text{GND} + 0.2\text{V} \leq V_O \leq V^+ - 0.2\text{V}$

Note 9: Connected as voltage follower with 2V_{PP} step input. Number specified is the slower of the positive and negative slew rates.

Note 10: Electrical Table values apply only for factory testing conditions at the temperature indicated. Factory testing conditions result in very limited self-heating of the device such that $T_J = T_A$. No guarantee of parametric performance is indicated in the electrical tables under conditions of internal self heating where $T_J > T_A$.

Connection Diagrams

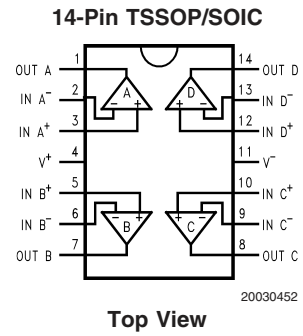
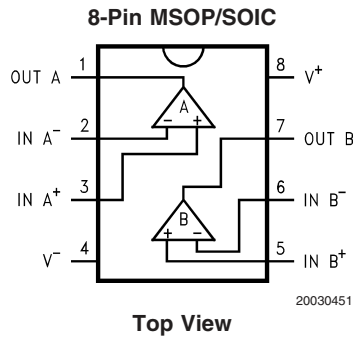
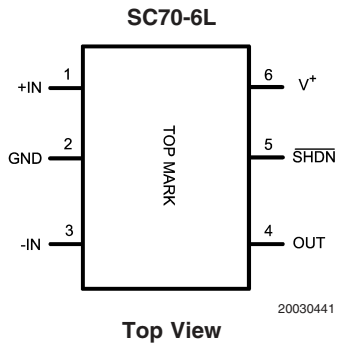

Ordering Information

Package	Part Number	Package Marking	Transport Media	NSC Drawing
6-Pin SC70	LMV341MG	A78	1k Units Tape and Reel	MAA06A
	LMV341MGX		3k Units Tape and Reel	
8-Pin MSOP	LMV342MM	A82A	1k Units Tape and Reel	MUA08A
	LMV342MMX		3.5k Units Tape and Reel	
8-Pin SOIC	LMV342MA	LMV342MA	95 Units/Rail	M08A
	LMV342MAX		2.5k Units Tape and Reel	
14-Pin TSSOP	LMV344MT	LMV344MT	Rails	MTC14
	LMV344MTX		2.5k Units Tape and Reel	
14-Pin SOIC	LMV344MA	LMV344MA	55 Units/Rail	M14A
	LMV344MAX		2.5k Units Tape and Reel	

Typical Performance Characteristics

Supply Current vs. Supply Voltage (LMV341)

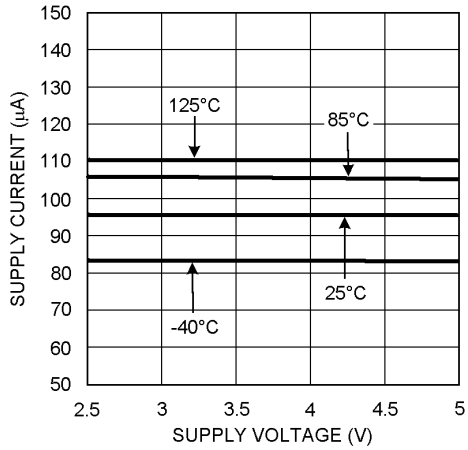

20030428

Input Current vs. Temperature

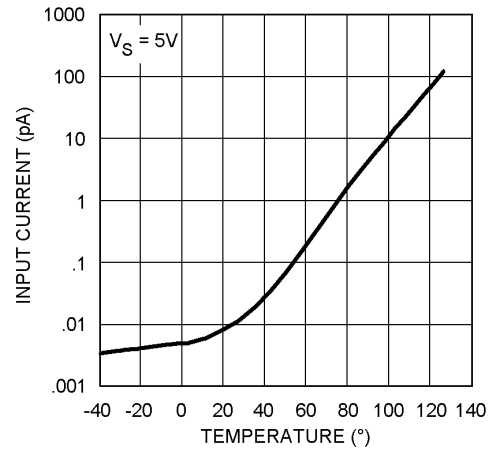

20030446

Output Voltage Swing vs. Supply Voltage

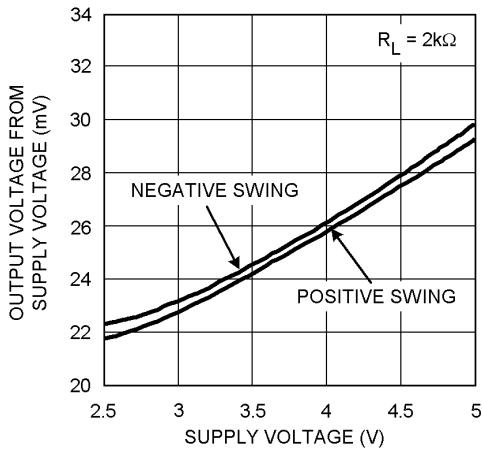

20030426

Output Voltage Swing vs. Supply Voltage

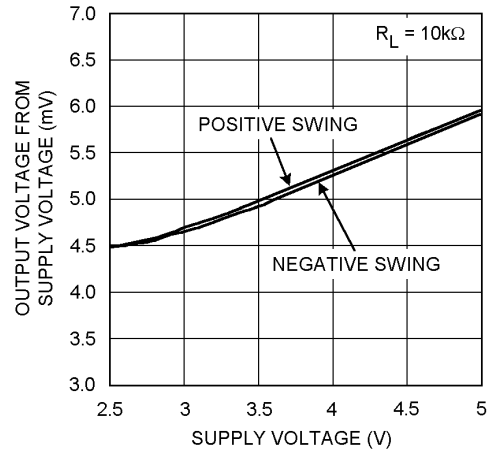

20030427

I_{SOURCE} vs. V_{OUT}

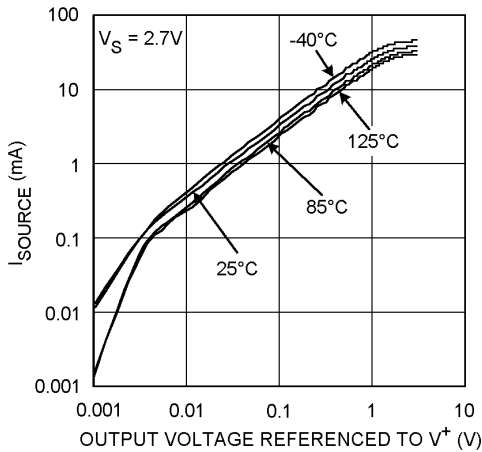

20030429

I_{SOURCE} vs. V_{OUT}

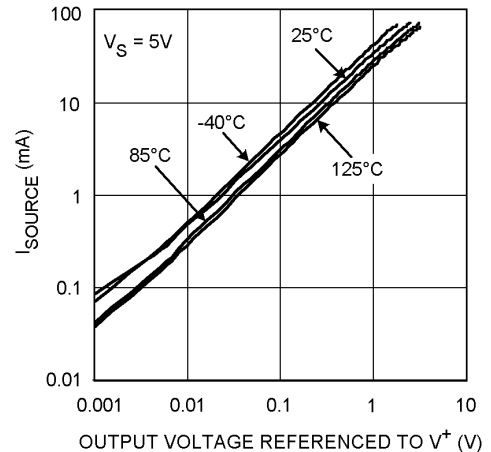

20030430

Typical Performance Characteristics (Continued)

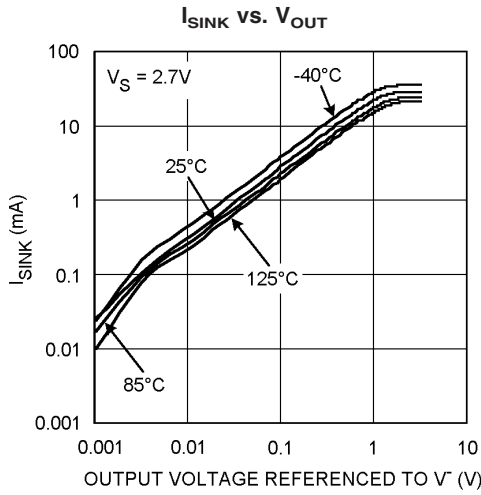

20030431

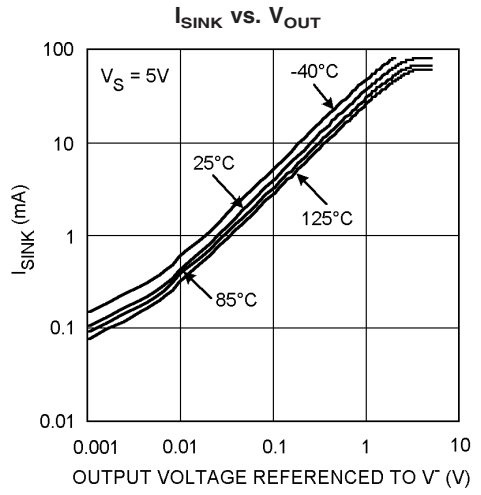

20030432

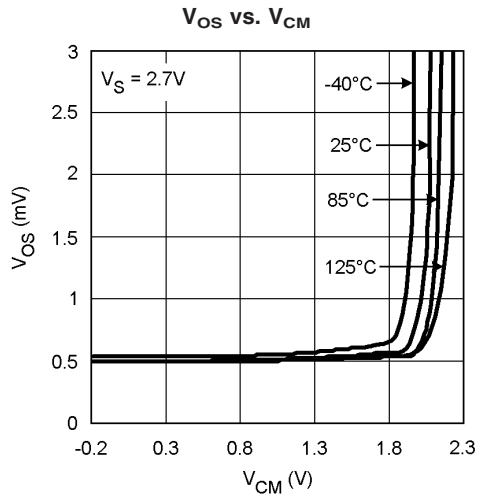

20030433

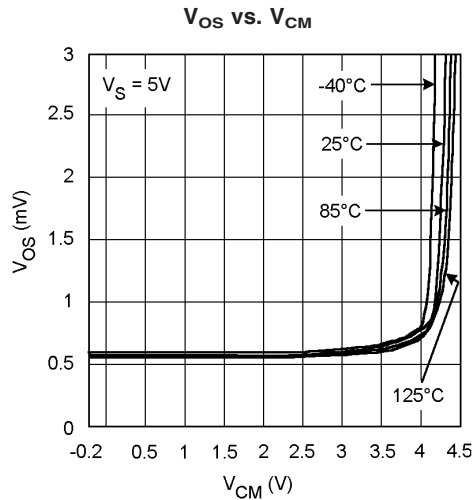

20030434

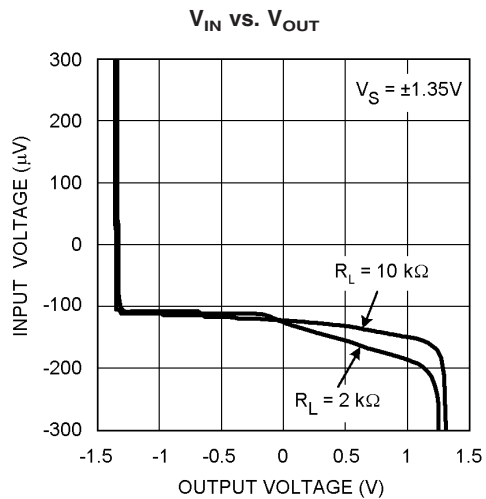

20030435

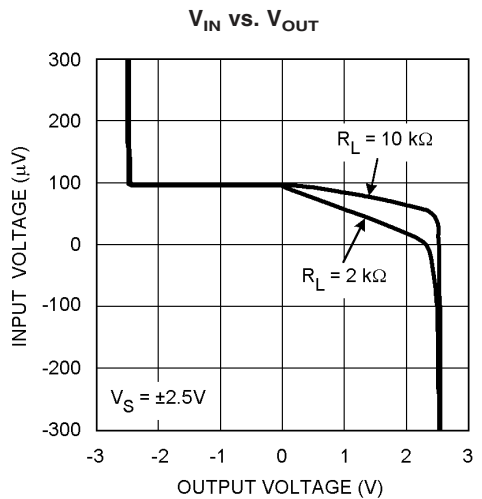

20030436

Typical Performance Characteristics (Continued)

CMRR vs. Frequency

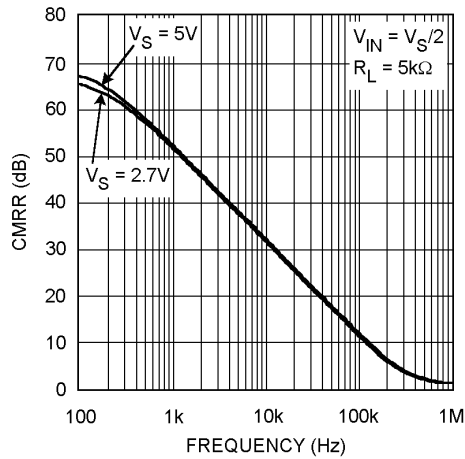

20030403

PSRR vs. Frequency

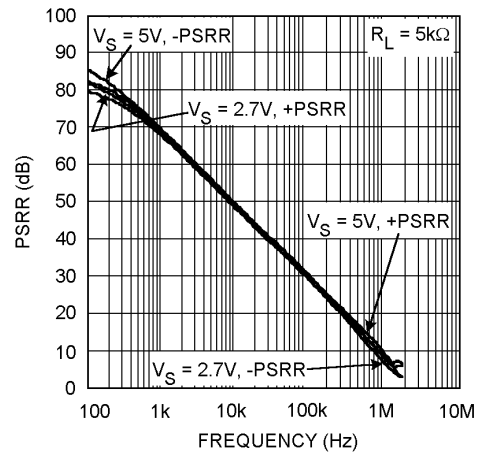

20030401

Input Voltage Noise vs. frequency

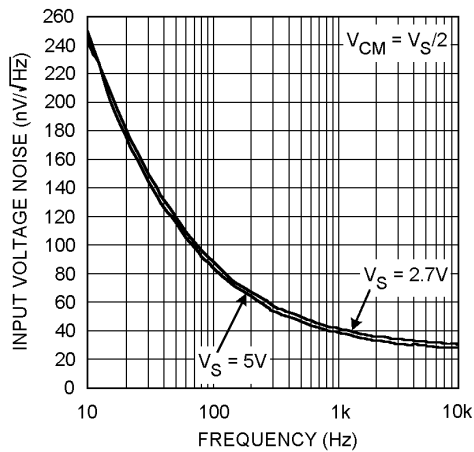

20030404

Slew Rate vs. V_{SUPPLY}

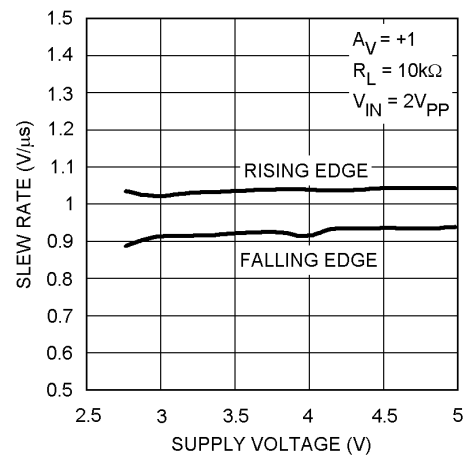

20030402

Slew Rate vs. Temperature

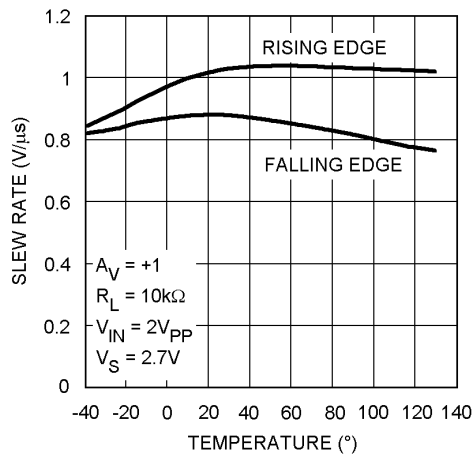

20030422

Slew Rate vs. Temperature

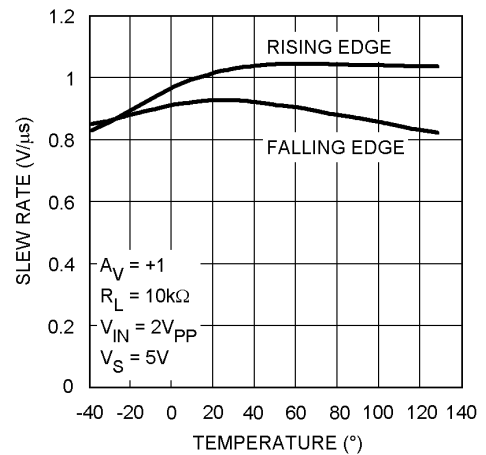

20030423

Typical Performance Characteristics (Continued)

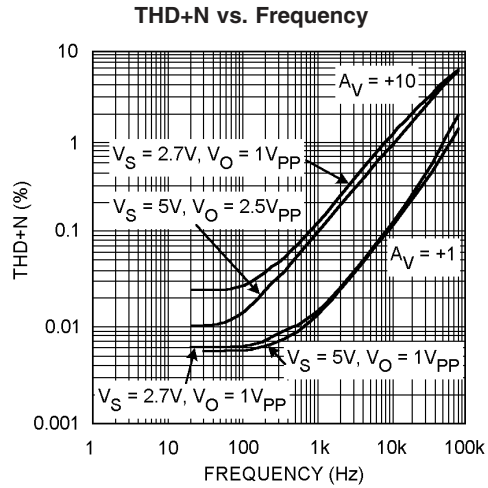

20030425

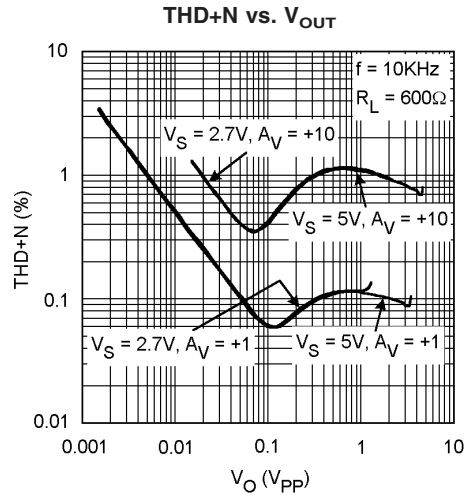

20030424

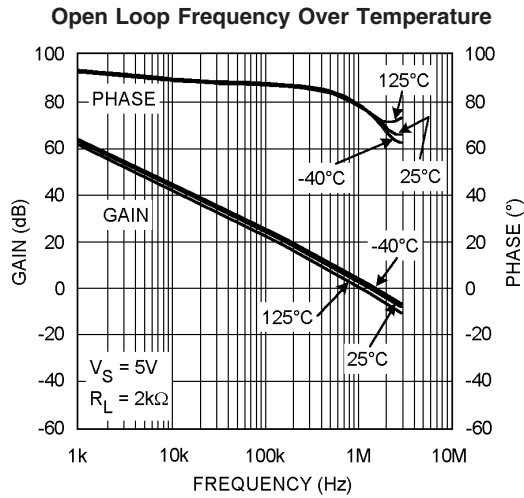

20030421

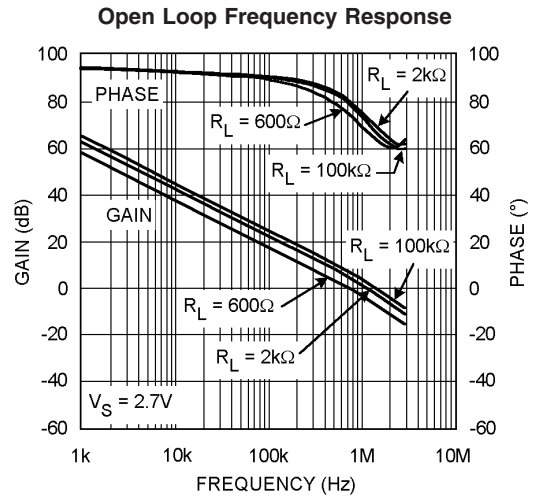

20030420

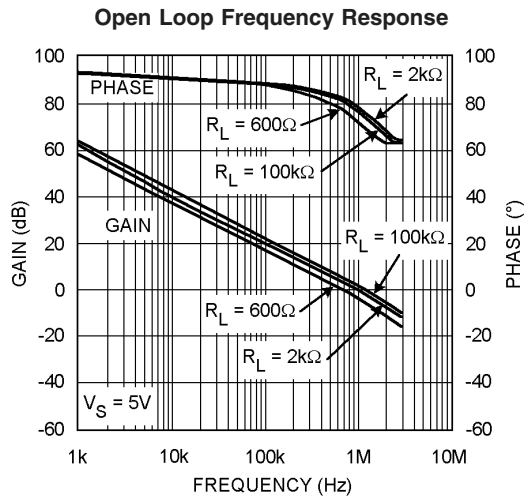

20030419

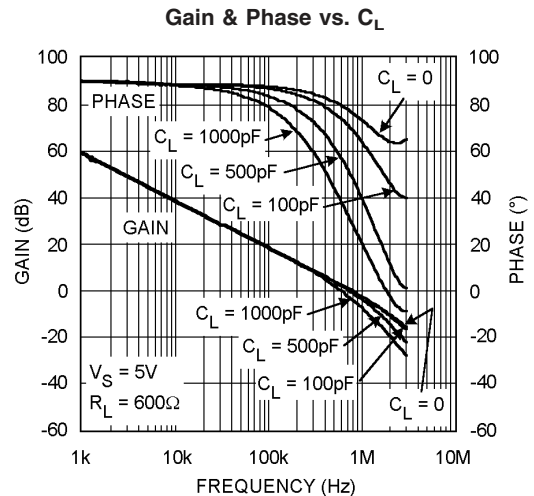

20030417

Typical Performance Characteristics (Continued)

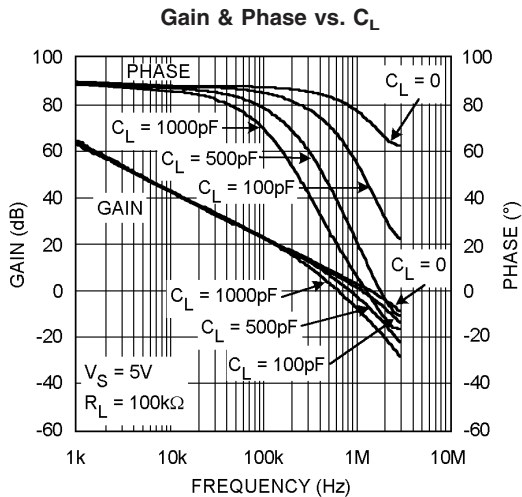

20030418

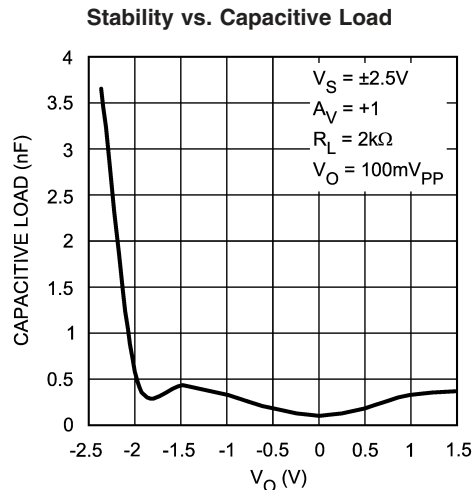

20030448

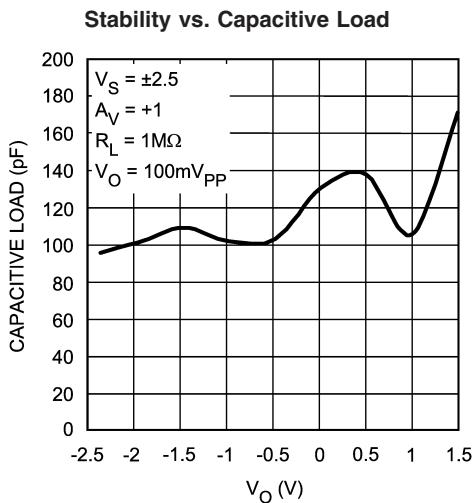

20030449

Non-Inverting Small Signal Pulse Response

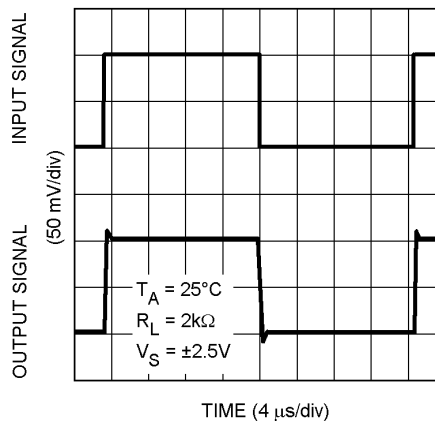

20030405

Non-Inverting Large Signal Pulse Response

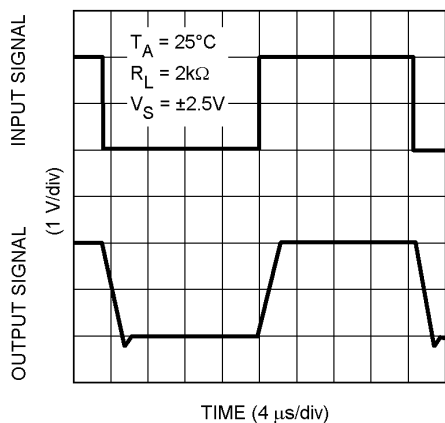

20030408

Non-Inverting Small Signal Pulse Response

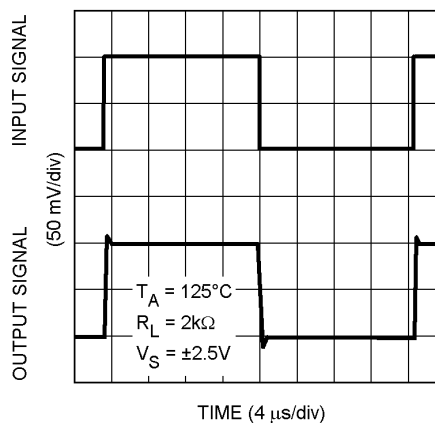

20030406

Typical Performance Characteristics (Continued)

Non-Inverting Large Signal Pulse Response

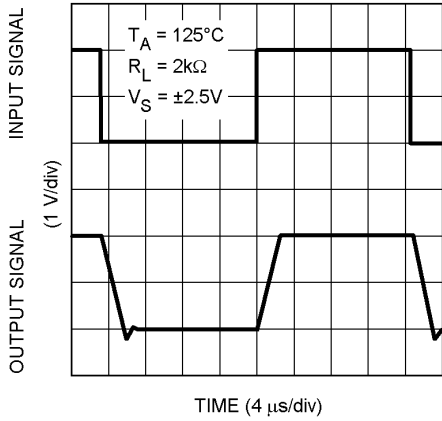

20030409

Non-Inverting Small Signal Pulse Response

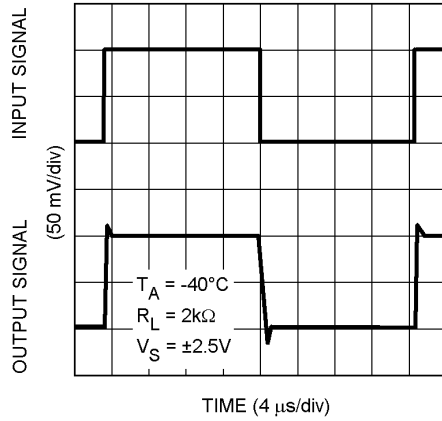

20030407

Non-Inverting Large Signal Pulse Response

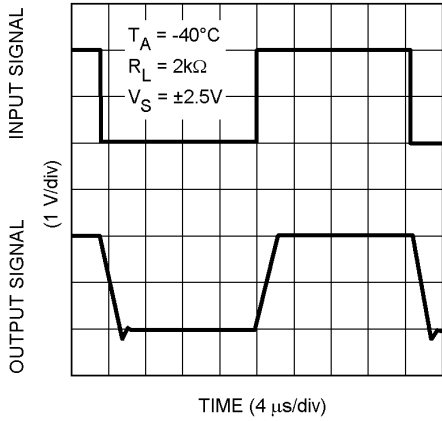

20030410

Inverting Small Signal Pulse Response

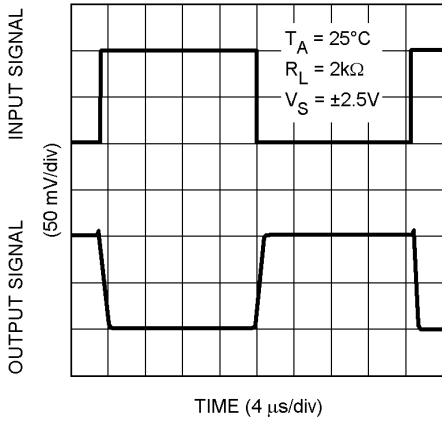

20030411

Inverting Large Signal Pulse Response

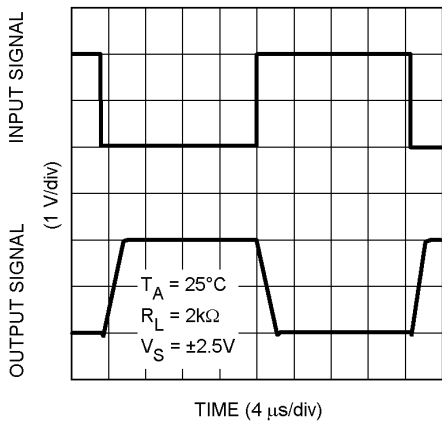

20030414

Inverting Small Signal Pulse Response

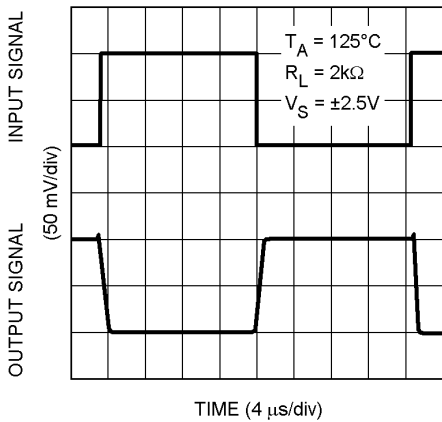

20030412

Typical Performance Characteristics (Continued)

Inverting Large Signal Pulse Response

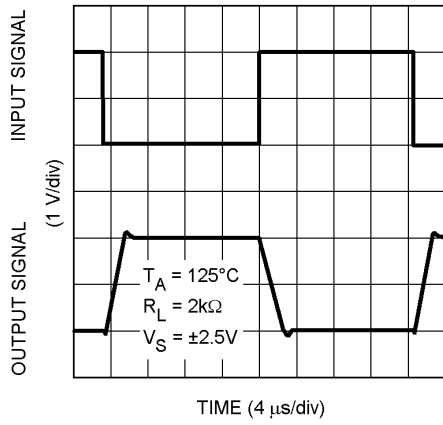

20030415

Inverting Small Signal Pulse Response

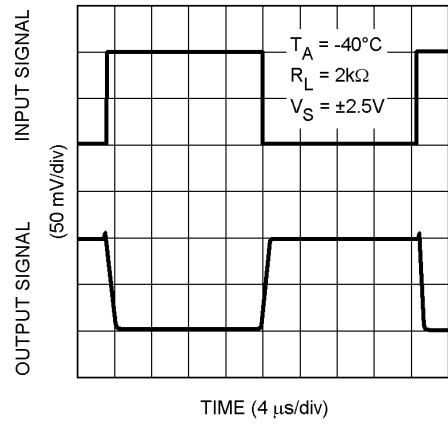

20030413

Inverting Large Signal Pulse Response

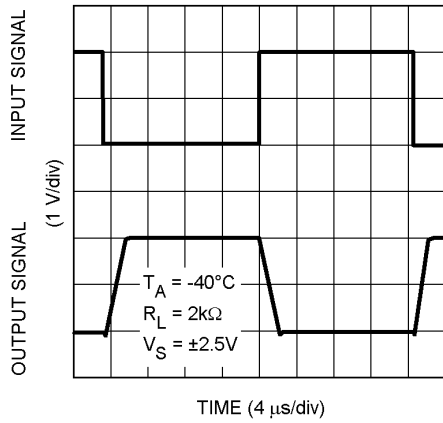

20030416

Crosstalk Rejection vs. Frequency

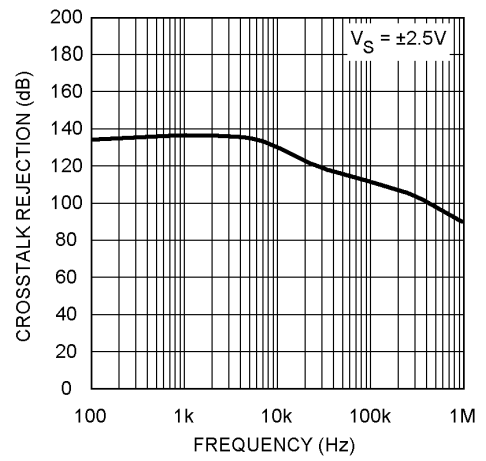

20030454

Application Section

LMV341/342/344

The LMV341/342/344 family of amplifiers features low voltage, low power, and rail-to-rail output operational amplifiers designed for low voltage portable applications. The family is designed using all CMOS technology. This results in an ultra low input bias current. The LMV341 has a shutdown option, which can be used in portable devices to increase battery life.

A simplified schematic of the LMV341/342/344 family of amplifiers is shown in *Figure 1*. The PMOS input differential pair allows the input to include ground. The output of this differential pair is connected to the Class AB turnaround stage. This Class AB turnaround has a lower quiescent current, compared to regular turnaround stages. This results in lower offset, noise, and power dissipation, while slew rate equals that of a conventional turnaround stage. The output of the Class AB turnaround stage provides gate voltage to the complementary common-source transistors at the output stage. These transistors enable the device to have rail-to-rail output.

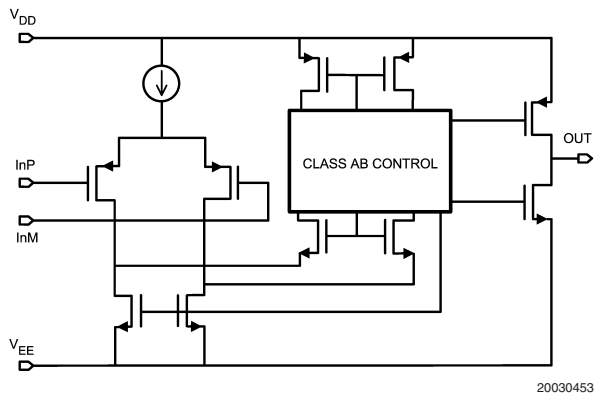

FIGURE 1. Simplified Schematic

CLASS AB TURNAROUND STAGE AMPLIFIER

This patented folded cascode stage has a combined class AB amplifier stage, which replaces the conventional folded cascode stage. Therefore, the class AB folded cascode stage runs at a much lower quiescent current compared to conventional folded cascode stages. This results in significantly smaller offset and noise contributions. The reduced offset and noise contributions in turn reduce the offset voltage level and the voltage noise level at the input of the LMV341/342/344. Also the lower quiescent current results in a high open-loop gain for the amplifier. The lower quiescent current does not affect the slew rate of the amplifier nor its ability to handle the total current swing coming from the input stage.

The input voltage noise of the device at low frequencies, below 1kHz, is slightly higher than devices with a BJT input stage; However the PMOS input stage results in a much lower input bias current and the input voltage noise drops at frequencies above 1kHz.

SAMPLE AND HOLD CIRCUIT

The lower input bias current of the LMV341 results in a very high input impedance. The output impedance when the device is in shutdown mode is quite high. These high imped-

ances, along with the ability of the shutdown pin to be derived from a separate power source, make LMV341 a good choice for sample and hold circuits. The sample clock should be connected to the shutdown pin of the amplifier to rapidly turn the device on or off.

Figure 2 shows the schematic of a simple sample and hold circuit. When the sample clock is high the first amplifier is in normal operation mode and the second amplifier acts as a buffer. The capacitor, which appears as a load on the first amplifier, will be charging at this time. The voltage across the capacitor is that of the non-inverting input of the first amplifier since it is connected as a voltage-follower. When the sample clock is low the first amplifier is shut off, bringing the output impedance to a high value. The high impedance of this output, along with the very high impedance on the input of the second amplifier, prevents the capacitor from discharging. There is very little voltage droop while the first amplifier is in shutdown mode. The second amplifier, which is still in normal operation mode and is connected as a voltage follower, also provides the voltage sampled on the capacitor at its output.

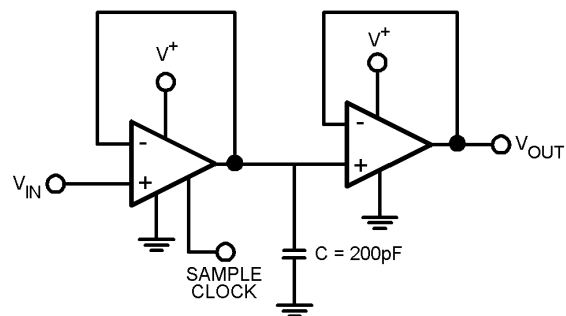

FIGURE 2. Sample and Hold Circuit

SHUTDOWN FEATURE

The LMV341 is capable of being turned off in order to conserve power and increase battery life in portable devices. Once in shutdown mode the supply current is drastically reduced, 1 μ A maximum, and the output will be "tri-stated."

The device will be disabled when the shutdown pin voltage is pulled low. The shutdown pin should never be left unconnected. Leaving the pin floating will result in an undefined operation mode and the device may oscillate between shutdown and active modes.

The LMV341 typically turns on 2.8 μ s after the shutdown voltage is pulled high. The device turns off in less than 400ns after shutdown voltage is pulled low. *Figure 3* and *Figure 4* show the turn-on and turn-off time of the LMV341, respectively. In order to reduce the effect of the capacitance added to the circuit by the scope probe, in the turn-off time circuit a resistive load of 600 Ω is added. *Figure 5* and *Figure 6* show the test circuits used to obtain the two plots.

Application Section (Continued)

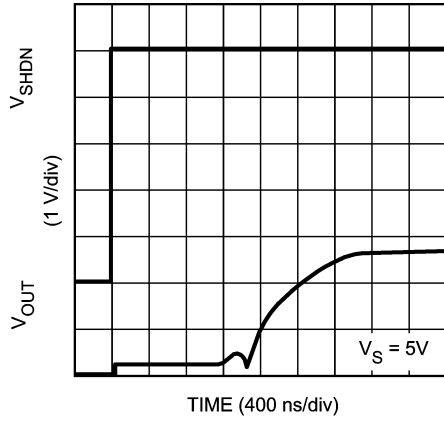

FIGURE 3. Turn-on Time

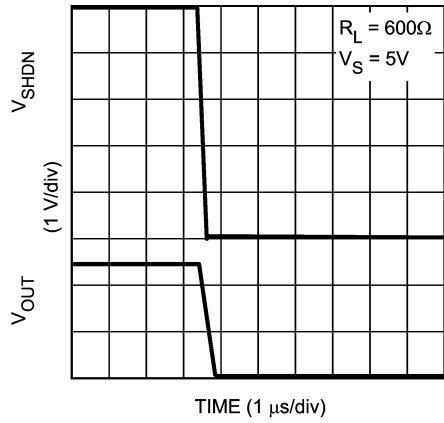

FIGURE 4. Turn-off Time

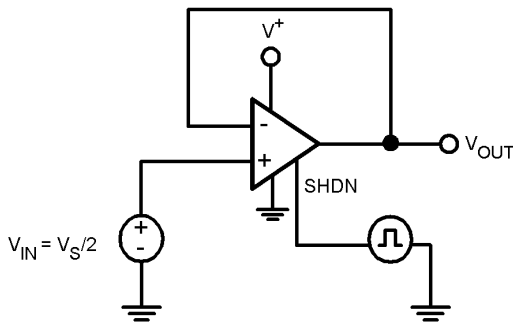

FIGURE 5. Turn-on Time

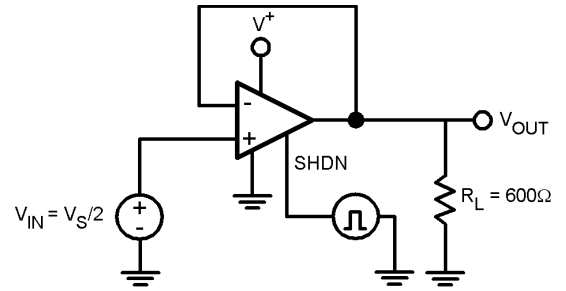

FIGURE 6. Turn-off Time

LOW INPUT BIAS CURRENT

The LMV341/LMV342/LMV344 Amplifiers have a PMOS input stage. As a result, they will have a much lower input bias current than devices with BJT input stages. This feature makes these devices ideal for sensor circuits. A typical curve of the input bias current of the LMV341 is shown in Figure 7.

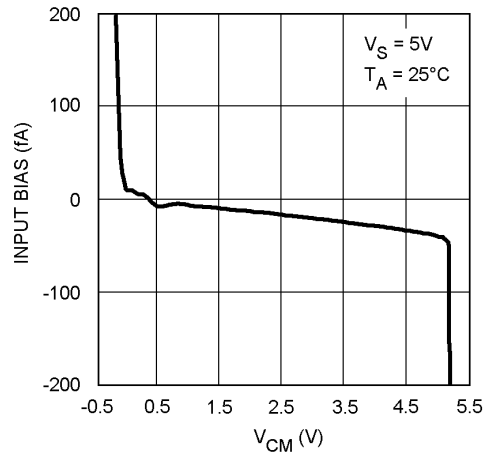
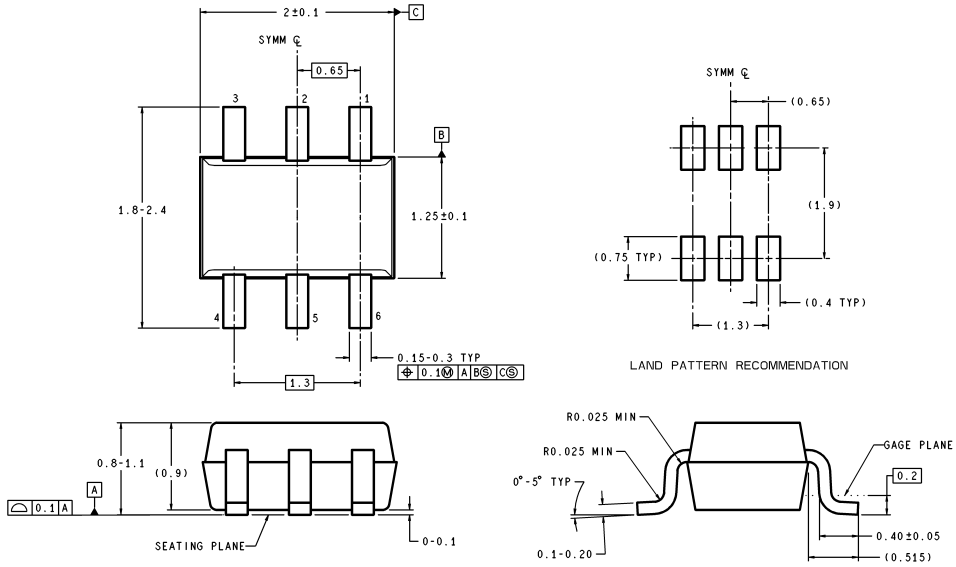

FIGURE 7. Input Bias Current vs. V_{CM}

Physical Dimensions inches (millimeters)

unless otherwise noted



DIMENSIONS ARE IN MILLIMETERS

MAA06A (Rev A)

6-Pin SC70 NS Package Number MAA06A

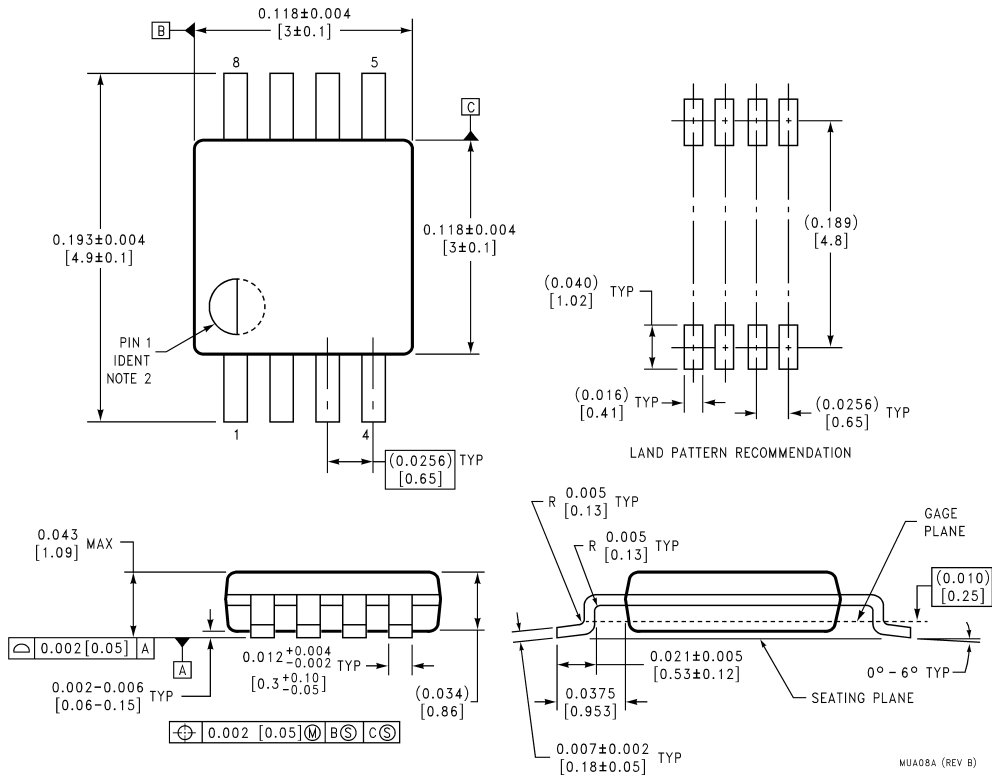

MUA08A (REV B)

8-Pin MSOP NS Package Number MUA08A

Physical Dimensions inches (millimeters) unless otherwise noted (Continued)

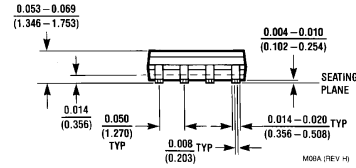
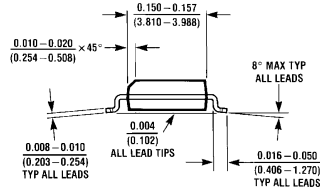
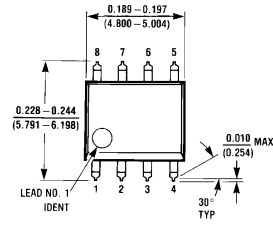

8-Pin SOIC
NS Package Number M08A

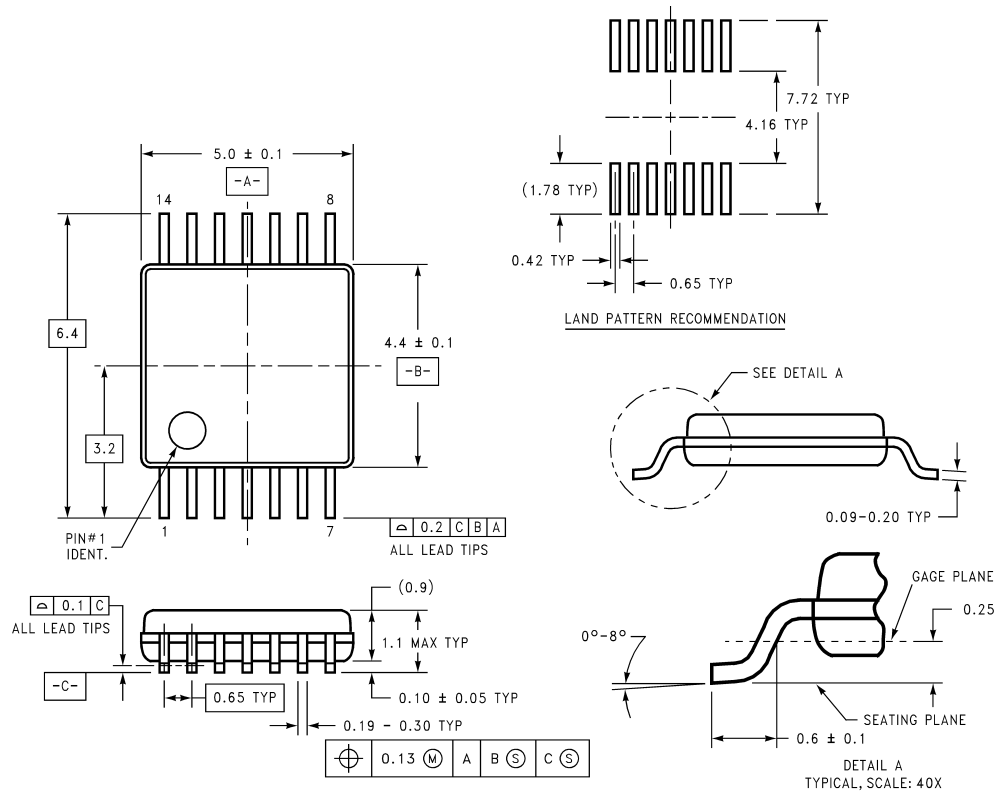

DIMENSIONS ARE IN MILLIMETERS

14-Pin TSSOP
NS Package Number MTC14

Physical Dimensions inches (millimeters) unless otherwise noted (Continued)

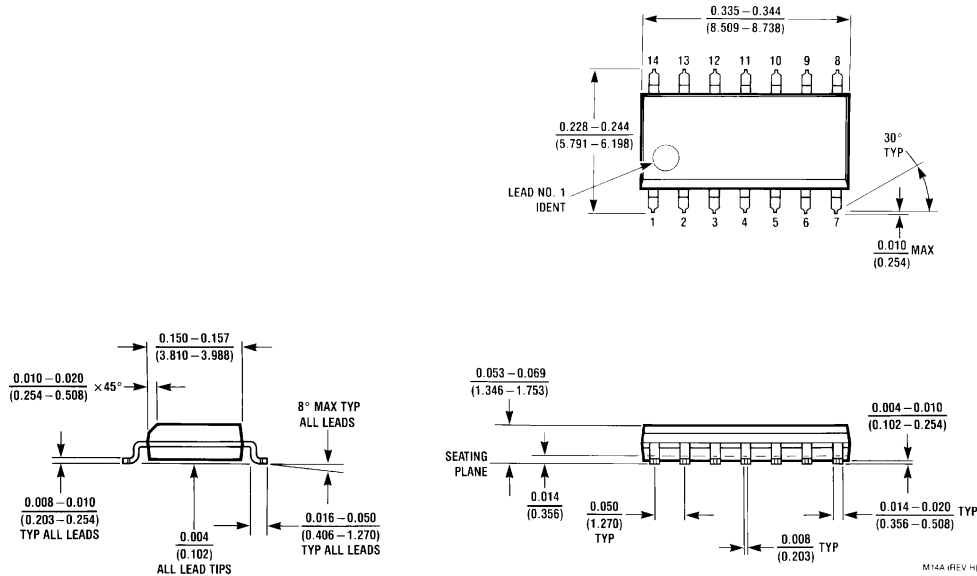

14-Pin SOIC
NS Package Number M14A

LIFE SUPPORT POLICY

NATIONAL'S PRODUCTS ARE NOT AUTHORIZED FOR USE AS CRITICAL COMPONENTS IN LIFE SUPPORT DEVICES OR SYSTEMS WITHOUT THE EXPRESS WRITTEN APPROVAL OF THE PRESIDENT AND GENERAL COUNSEL OF NATIONAL SEMICONDUCTOR CORPORATION. As used herein:

1. Life support devices or systems are devices or systems which, (a) are intended for surgical implant into the body, or (b) support or sustain life, and whose failure to perform when properly used in accordance with instructions for use provided in the labeling, can be reasonably expected to result in a significant injury to the user.
2. A critical component is any component of a life support device or system whose failure to perform can be reasonably expected to cause the failure of the life support device or system, or to affect its safety or effectiveness.



National Semiconductor
Americas Customer
Support Center
Email: new.feedback@nsc.com
Tel: 1-800-272-9959

National Semiconductor
Europe Customer Support Center
Fax: +49 (0) 180-530 85 86
Email: europe.support@nsc.com
Deutsch Tel: +49 (0) 69 9508 6208
English Tel: +44 (0) 870 24 0 2171
Français Tel: +33 (0) 1 41 91 8790

National Semiconductor
Asia Pacific Customer
Support Center
Fax: +65-6250 4466
Email: ap.support@nsc.com
Tel: +65-6254 4466

National Semiconductor
Japan Customer Support Center
Fax: 81-3-5639-7507
Email: jpn.feedback@nsc.com
Tel: 81-3-5639-7560

www.national.com