

LM45B/LM45C SOT-23 Precision Centigrade Temperature Sensors

General Description

The LM45 series are precision integrated-circuit temperature sensors, whose output voltage is linearly proportional to the Celsius (Centigrade) temperature. The LM45 does not require any external calibration or trimming to provide accuracies of $\pm 2^\circ\text{C}$ at room temperature and $\pm 3^\circ\text{C}$ over a full -20 to $+100^\circ\text{C}$ temperature range. Low cost is assured by trimming and calibration at the wafer level. The LM45's low output impedance, linear output, and precise inherent calibration make interfacing to readout or control circuitry especially easy. It can be used with a single power supply, or with plus and minus supplies. As it draws only $120\ \mu\text{A}$ from its supply, it has very low self-heating, less than 0.2°C in still air. The LM45 is rated to operate over a -20° to $+100^\circ\text{C}$ temperature range.

Applications

- Battery Management
- FAX Machines
- Printers

- Portable Medical Instruments
- HVAC
- Power Supply Modules
- Disk Drives
- Computers
- Automotive

Features

- Calibrated directly in $^\circ\text{C}$ (Centigrade)
- Linear $+10.0\ \text{mV}/^\circ\text{C}$ scale factor
- $\pm 3^\circ\text{C}$ accuracy guaranteed
- Rated for full -20° to $+100^\circ\text{C}$ range
- Suitable for remote applications
- Low cost due to wafer-level trimming
- Operates from 4.0V to 10V
- Less than $120\ \mu\text{A}$ current drain
- Low self-heating, 0.2°C in still air
- Nonlinearity only $\pm 0.8^\circ\text{C}$ max over temp
- Low impedance output, $20\ \Omega$ for $1\ \text{mA}$ load

Connection Diagram

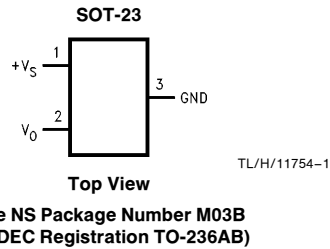

Order Number	SOT-23 Device Marking	Supplied As
LM45BIM3	T4B	250 Units on Tape and Reel
LM45BIM3X	T4B	3000 Units on Tape and Reel
LM45CIM3	T4C	250 Units on Tape and Reel
LM45CIM3X	T4C	3000 Units on Tape and Reel

Typical Applications

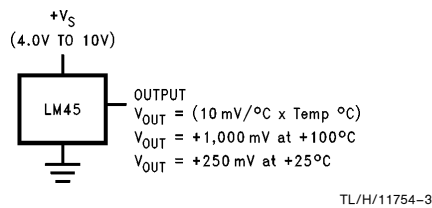
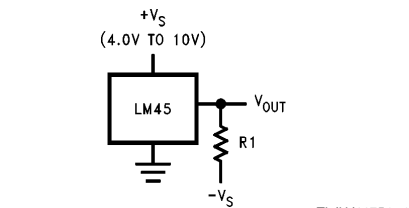

FIGURE 1. Basic Centigrade Temperature Sensor ($+2.5^\circ\text{C}$ to $+100^\circ\text{C}$)



Choose $R_1 = -V_S/50\ \mu\text{A}$

$V_{\text{OUT}} = (10\ \text{mV}/^\circ\text{C} \times \text{Temp } ^\circ\text{C})$
 $V_{\text{OUT}} = +1,000\ \text{mV}$ at $+100^\circ\text{C}$
 $= +250\ \text{mV}$ at $+25^\circ\text{C}$
 $= -200\ \text{mV}$ at -20°C

FIGURE 2. Full-Range Centigrade Temperature Sensor (-20°C to $+100^\circ\text{C}$)

Absolute Maximum Ratings (Note 1)

Supply Voltage	+12V to -0.2V
Output Voltage	+V _S + 0.6V to -1.0V
Output Current	10 mA
Storage Temperature	-65°C to +150°C
Lead Temperature	
SOT Package (Note 2):	
Vapor Phase (60 seconds)	215°C
Infrared (15 seconds)	220°C

ESD Susceptibility (Note 3):	
Human Body Model	2000V
Machine Model	TBD

Operating Ratings (Note 1)

Specified Temperature Range (Note 4)	T _{MIN} to T _{MAX} -20°C to +100°C
Operating Temperature Range	-40°C to +125°C
Supply Voltage Range (+V _S)	+4.0V to +10V

Electrical Characteristics Unless otherwise noted, these specifications apply for +V_S = +5Vdc and I_L = +50 μA, in the circuit of *Figure 2*. These specifications also apply from +2.5°C to T_{MAX} in the circuit of *Figure 1* for +V_S = +5Vdc. **Boldface limits apply for T_A = T_J = T_{MIN} to T_{MAX}**; all other limits T_A = T_J = +25°C, unless otherwise noted.

Parameter	Conditions	LM45B		LM45C		Units (Limit)
		Typical	Limit (Note 5)	Typical	Limit (Note 5)	
Accuracy (Note 6)	T _A = +25°C T _A = T _{MAX} T _A = T _{MIN}		±2.0 ±3.0 ±3.0		±3.0 ±4.0 ±4.0	°C (max) °C (max) °C (max)
Nonlinearity (Note 7)	T _{MIN} ≤ T _A ≤ T _{MAX}		± 0.8		± 0.8	°C (max)
Sensor Gain (Average Slope)	T _{MIN} ≤ T _A ≤ T _{MAX}		+ 9.7 + 10.3		+ 9.7 + 10.3	mV/°C (min) mV/°C (max)
Load Regulation (Note 8)	0 ≤ I _L ≤ +1 mA		± 35		± 35	mV/mA (max)
Line Regulation (Note 8)	+4.0V ≤ +V _S ≤ +10V		±0.80 ± 1.2		±0.80 ± 1.2	mV/V (max) mV/V (max)
Quiescent Current (Note 9)	+4.0V ≤ +V _S ≤ +10V, +25°C +4.0V ≤ +V _S ≤ +10V		120 160		120 160	μA (max) μA (max)
Change of Quiescent Current (Note 8)	4.0V ≤ +V _S ≤ 10V		2.0		2.0	μA (max)
Temperature Coefficient of Quiescent Current			+ 2.0		+ 2.0	μA/°C
Minimum Temperature for Rated Accuracy	In circuit of <i>Figure 1</i> , I _L = 0		+2.5		+2.5	°C (min)
Long Term Stability (Note 10)	T _J = T _{MAX} , for 1000 hours		±0.12		±0.12	°C

Note 1: Absolute Maximum Ratings indicate limits beyond which damage to the device may occur. DC and AC electrical specifications do not apply when operating the device beyond its rated operating conditions.

Note 2: See AN-450 "Surface Mounting Methods and Their Effect on Product Reliability" or the section titled "Surface Mount" found in a current National Semiconductor Linear Data Book for other methods of soldering surface mount devices.

Note 3: Human body model, 100 pF discharged through a 1.5 kΩ resistor. Machine model, 200 pF discharged directly into each pin.

Note 4: Thermal resistance of the SOT-23 package is 260°C/W, junction to ambient when attached to a printed circuit board with 2 oz. foil as shown in *Figure 3*.

Note 5: Limits are guaranteed to National's AOQL (Average Outgoing Quality Level).

Note 6: Accuracy is defined as the error between the output voltage and 10 mv/°C times the device's case temperature, at specified conditions of voltage, current, and temperature (expressed in °C).

Note 7: Nonlinearity is defined as the deviation of the output-voltage-versus-temperature curve from the best-fit straight line, over the device's rated temperature range.

Note 8: Regulation is measured at constant junction temperature, using pulse testing with a low duty cycle. Changes in output due to heating effects can be computed by multiplying the internal dissipation by the thermal resistance.

Note 9: Quiescent current is measured using the circuit of *Figure 1*.

Note 10: For best long-term stability, any precision circuit will give best results if the unit is aged at a warm temperature, and/or temperature cycled for at least 46 hours before long-term life test begins. This is especially true when a small (Surface-Mount) part is wave-soldered; allow time for stress relaxation to occur.

Typical Performance Characteristics

To generate these curves the LM45 was mounted to a printed circuit board as shown in *Figure 3*.

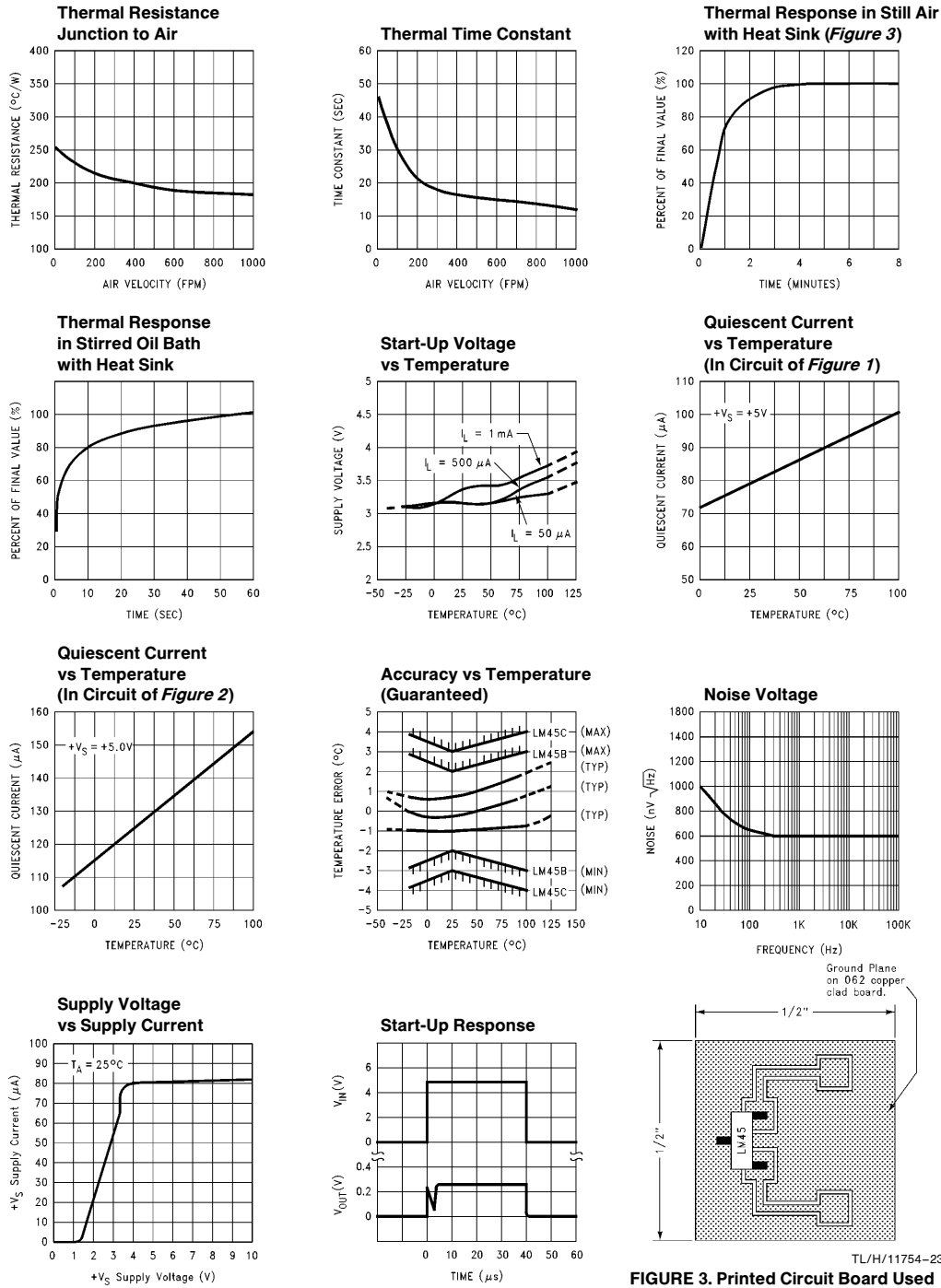

FIGURE 3. Printed Circuit Board Used for Heat Sink to Generate All Curves. 1/2" Square Printed Circuit Board with 2 oz. Foil or Similar

Applications

The LM45 can be applied easily in the same way as other integrated-circuit temperature sensors. It can be glued or cemented to a surface and its temperature will be within about 0.2°C of the surface temperature.

This presumes that the ambient air temperature is almost the same as the surface temperature; if the air temperature were much higher or lower than the surface temperature, the actual temperature of the LM45 die would be at an intermediate temperature between the surface temperature and the air temperature.

To ensure good thermal conductivity the backside of the LM45 die is directly attached to the GND pin. The lands and traces to the LM45 will, of course, be part of the printed circuit board, which is the object whose temperature is being measured. These printed circuit board lands and traces will not cause the LM45s temperature to deviate from the desired temperature.

Alternatively, the LM45 can be mounted inside a sealed-end metal tube, and can then be dipped into a bath or screwed

into a threaded hole in a tank. As with any IC, the LM45 and accompanying wiring and circuits must be kept insulated and dry, to avoid leakage and corrosion. This is especially true if the circuit may operate at cold temperatures where condensation can occur. Printed-circuit coatings and varnishes such as Humiseal and epoxy paints or dips are often used to insure that moisture cannot corrode the LM45 or its connections.

Temperature Rise of LM45 Due to Self-Heating (Thermal Resistance)

	SOT-23** no heat sink	SOT-23 small heat fin*
Still air	450°C/W	260°C/W
Moving air		180°C/W

* Heat sink used is 1/2" square printed circuit board with 2 oz. foil with part attached as shown in Figure 3.

** Part soldered to 30 gauge wire.

Typical Applications

CAPACITIVE LOADS

Like most micropower circuits, the LM45 has a limited ability to drive heavy capacitive loads. The LM45 by itself is able to drive 500 pF without special precautions. If heavier loads are anticipated, it is easy to isolate or decouple the load with a resistor; see Figure 4. Or you can improve the tolerance of capacitance with a series R-C damper from output to ground; see Figure 5.

Any linear circuit connected to wires in a hostile environment can have its performance affected adversely by intense electromagnetic sources such as relays, radio transmitters, motors with arcing brushes, SCR transients, etc, as its wiring can act as a receiving antenna and its internal junctions can act as rectifiers. For best results in such cases, a bypass capacitor from V_{IN} to ground and a series R-C damper such as 75 Ω in series with 0.2 or 1 μ F from output to ground, as shown in Figure 5, are often useful.

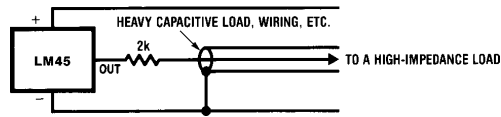

TL/H/11754-8

FIGURE 4. LM45 with Decoupling from Capacitive Load

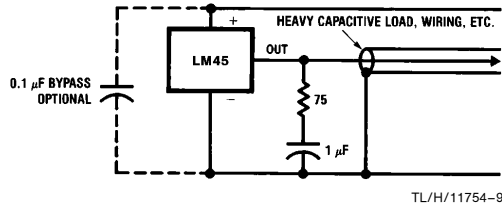

TL/H/11754-9

FIGURE 5. LM45 with R-C Damper

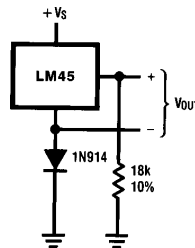

TL/H/11754-12

FIGURE 6. Temperature Sensor,
Single Supply, -20°C to +100°C

LM45B/LM45C
SOT-23 Precision Centigrade Temperature Sensors

Physical Dimensions inches (millimeters)

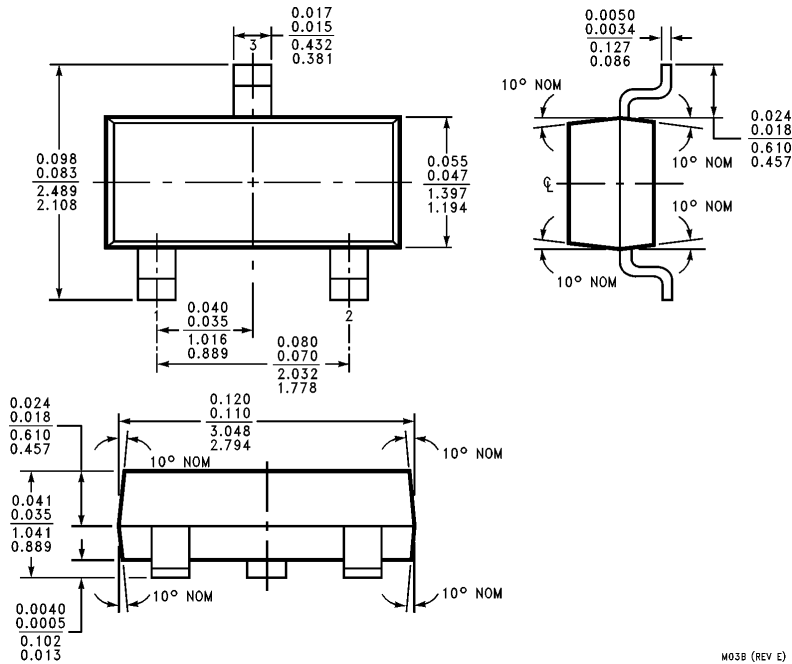

M03B (REV E)

SOT-23 Molded Small Outline Transistor Package (M3)
Order Number LM45BIM3, LM45BIM3X, LM45CIM3 or LM45CIM3X
NS Package Number M03B
(JEDEC Registration TO-236AB)

LIFE SUPPORT POLICY

NATIONAL'S PRODUCTS ARE NOT AUTHORIZED FOR USE AS CRITICAL COMPONENTS IN LIFE SUPPORT DEVICES OR SYSTEMS WITHOUT THE EXPRESS WRITTEN APPROVAL OF THE PRESIDENT OF NATIONAL SEMICONDUCTOR CORPORATION. As used herein:

- Life support devices or systems are devices or systems which, (a) are intended for surgical implant into the body, or (b) support or sustain life, and whose failure to perform, when properly used in accordance with instructions for use provided in the labeling, can be reasonably expected to result in a significant injury to the user.
- A critical component is any component of a life support device or system whose failure to perform can be reasonably expected to cause the failure of the life support device or system, or to affect its safety or effectiveness.



National Semiconductor Corporation
 2900 Semiconductor Drive
 P.O. Box 58090
 Santa Clara, CA 95052-8090
 Tel: 1(800) 272-9959
 TWX: (910) 339-9240

National Semiconductor GmbH
 Livny-Gargan-Str. 10
 D-82256 Fürstenfeldbruck
 Germany
 Tel: (81-41) 35-0
 Telex: 527849
 Fax: (81-41) 35-1

National Semiconductor Japan Ltd.
 Sumitomo Chemical
 Engineering Center
 Bldg. 7F
 1-7-1, Nakase, Mihama-Ku
 Chiba-City,
 Chiba Prefecture 261
 Tel: (043) 299-2300
 Fax: (043) 299-2500

National Semiconductor Hong Kong Ltd.
 13th Floor, Straight Block,
 Ocean Centre, 5 Canton Rd.
 Tsimshatsui, Kowloon
 Hong Kong
 Tel: (852) 2737-1600
 Fax: (852) 2736-9960

National Semicondutores Do Brazil Ltda.
 Rue Deputado Lacorda Franco
 120-3A
 Sao Paulo-SP
 Brazil 05418-000
 Tel: (55-11) 212-5066
 Telex: 391-1131931 NSBR BR
 Fax: (55-11) 212-1181

National Semiconductor (Australia) Pty. Ltd.
 Building 16
 Business Park Drive
 Monash Business Park
 Nottingham, Melbourne
 Victoria 3168 Australia
 Tel: (3) 558-9999
 Fax: (3) 558-9998

National does not assume any responsibility for use of any circuitry described, no circuit patent licenses are implied and National reserves the right at any time without notice to change said circuitry and specifications.