

## LM2990 Negative Low Dropout Regulator

### General Description

The LM2990 is a three-terminal, low dropout, 1 ampere negative voltage regulator available with fixed output voltages of -5, -5.2, -12, and -15V.

The LM2990 uses new circuit design techniques to provide low dropout and low quiescent current. The dropout voltage at 1A load current is typically 0.6V and a guaranteed worst-case maximum of 1V over the entire operating temperature range. The quiescent current is typically 1 mA with 1A load current and an input-output voltage differential greater than 3V. A unique circuit design of the internal bias supply limits the quiescent current to only 9 mA (typical) when the regulator is in the dropout mode ( $V_{OUT} - V_{IN} \leq 3V$ ). Output voltage accuracy is guaranteed to  $\pm 5\%$  over load, and temperature extremes.

The LM2990 is short-circuit proof, and thermal shutdown includes hysteresis to enhance the reliability of the device when overloaded for an extended period of time. The

LM2990 is available in a 3-lead TO-220 package and is rated for operation over the automotive temperature range of  $-40^{\circ}\text{C}$  to  $+125^{\circ}\text{C}$ .

### Features

- 5% output accuracy over entire operating range
- Output current in excess of 1A
- Dropout voltage typically 0.6V at 1A load
- Low quiescent current
- Internal short circuit current limit
- Internal thermal shutdown with hysteresis
- Functional complement to the LM2940 series

### Applications

- Post switcher regulator
- Local, on-card, regulation
- Battery operated equipment

### Typical Application

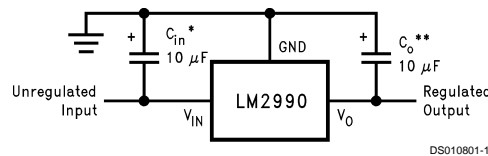

\*Required if the regulator is located further than 6 inches from the power supply filter capacitors. A 1  $\mu\text{F}$  solid tantalum or a 10  $\mu\text{F}$  aluminum electrolytic capacitor is recommended.

\*\*Required for stability. Must be at least a 10  $\mu\text{F}$  aluminum electrolytic or a 1  $\mu\text{F}$  solid tantalum to maintain stability. May be increased without bound to maintain regulation during transients. Locate the capacitor as close as possible to the regulator. The equivalent series resistance (ESR) is critical, and should be less than 10 $\Omega$  over the same operating temperature range as the regulator.

### Ordering Information and Connection Diagrams

Temperature Range	Output Voltage				Package
	-5.0	-5.2	-12	-15	
$-40^{\circ}\text{C}$ to $+125^{\circ}\text{C}$	LM2990T-5.0	LM2990T-5.2	LM2990T-12	LM2990T-15	TO-220
	LM2990S-5.0		LM2990S-12	LM2990S-15	TO-263
$-55^{\circ}\text{C}$ to $+125^{\circ}\text{C}$	LM2990J-5.0-QML 5962-9571101QEA		LM2990J-12-QML 5962-9571001QEA	LM2990J-15-QML 5962-9570901QEA	J16A
	LM2990WG5.0-QML 5962-9571101QXA				WG16A

## Ordering Information and Connection Diagrams (Continued)

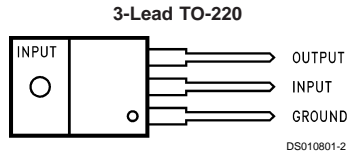

**Front View**

Order Number LM2990T-5.0, LM2990T-5.2, LM2990T-12  
or LM2990T-15

See NS Package Number T03B

### TO-263 Surface-Mount Package

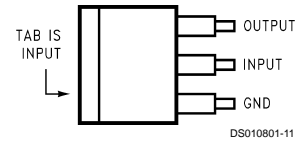

**Top View**



**Side View**

Order Number LM2990S-5.0, LM2990S-12 or  
LM2990S-15

See NS Package Number TS3B

### 16-Lead Ceramic Dual-in-Line Package

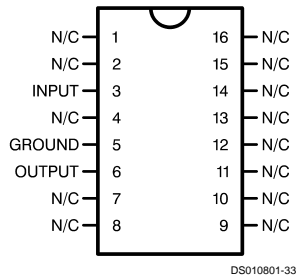

**Top View**

Order Number  
LM2990J-5.0-QML (5962-9571101QEA),  
LM2990J-12-QML (5962-9571001QEA), or  
LM2990J-15-QML (5962-9570901QEA),  
See NS Package Number J16A

### 16-Lead Ceramic Surface Mount Package

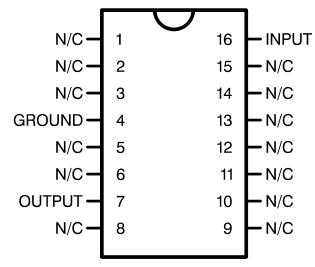

**Top View**

Order Number  
LM2990WG5.0-QML (5962-9571101QXEA)  
See NS Package Number WG16A

## Absolute Maximum Ratings (Note 1)

If Military/Aerospace specified devices are required, please contact the National Semiconductor Sales Office/Distributors for availability and specifications.

Input Voltage	-26V to +0.3V
ESD Susceptibility (Note 2)	2 kV
Power Dissipation (Note 3)	Internally Limited
Junction Temperature ( $T_{Jmax}$ )	125°C

Storage Temperature	-65°C to +150°C
Lead Temperature (Soldering, 10 sec.)	260°C

## Operating Ratings (Note 1)

Junction Temperature Range ( $T_J$ )	-40°C to +125°C
Maximum Input Voltage (Operational)	-26V

## Electrical Characteristics

$V_{IN} = -5V + V_{O(NOM)}$  (Note 6),  $I_O = 1A$ ,  $C_O = 47 \mu F$ , unless otherwise specified. **Boldface** limits apply over the entire operating temperature range,  $-40^\circ C \leq T_J \leq 125^\circ C$ , all other limits apply for  $T_J = 25^\circ C$ .

Parameter	Conditions	LM2990-5.0		LM2990-5.2		Units (Limit)
		Typ (Note 4)	Limit (Note 5)	Typ (Note 4)	Limit (Note 5)	
Output Voltage ( $V_O$ )	$5 mA \leq I_O \leq 1A$	-5	-4.90 -5.10	-5.2	-5.10 -5.30	V (max) mV (min) V
	$5 mA \leq I_O \leq 1A$		<b>-4.75</b> <b>-5.25</b>		<b>-4.94</b> <b>-5.46</b>	V (max) V (min)
Line Regulation	$I_O = 5 mA$ , $V_{O(NOM)} - 1V > V_{IN} > -26V$	4	40	4	40	mV (max)
Load Regulation	$50 mA \leq I_O \leq 1A$	1	40	1	40	mV (max)
Dropout Voltage	$I_O = 0.1A$ , $\Delta V_O \leq 100 mV$	0.1	<b>0.3</b>	0.1	<b>0.3</b>	V (max)
	$I_O = 1A$ , $\Delta V_O \leq 100 mV$	0.6	<b>1</b>	0.6	<b>1</b>	V (max)
Quiescent Current ( $I_q$ )	$I_O \leq 1A$	1	5	1	5	mA (max)
	$I_O = 1A$ , $V_{IN} = V_{O(NOM)}$	9	50	9	50	mA (max)
Short Circuit Current	$R_L = 1\Omega$ (Note 7)	1.8	1.5	1.8	1.5	A (min)
Maximum Output Current	(Note 7)	1.8	1.5	1.8	1.5	A (min)
Ripple Rejection	$V_{ripple} = 1 V_{rms}$ , $f_{ripple} = 1 kHz$ , $I_O = 5 mA$	58	50	58	50	dB (min)
Output Noise Voltage	10 Hz–100 kHz, $I_O = 5 mA$	250	750	250	750	$\mu V$ (max)
Long Term Stability	1000 Hours	2000		2000		ppm

## Electrical Characteristics

$V_{IN} = -5V + V_{O(NOM)}$  (Note 6),  $I_O = 1A$ ,  $C_O = 47 \mu F$ , unless otherwise specified. **Boldface** limits apply over the entire operating temperature range,  $-40^\circ C \leq T_J \leq 125^\circ C$ , all other limits apply for  $T_J = 25^\circ C$ .

Parameter	Conditions	LM2990-12		LM2990-15		Units (Limit)
		Typ (Note 4)	Limit (Note 5)	Typ (Note 4)	Limit (Note 5)	
Output Voltage ( $V_O$ )	$5 mA \leq I_O \leq 1A$	-12	-11.76 -12.24	-15	-14.70 -15.30	V (max) V (min) V
	$5 mA \leq I_O \leq 1A$		<b>-11.40</b> <b>-12.60</b>		<b>-14.25</b> <b>-15.75</b>	V (max) V (min)
Line Regulation	$I_O = 5 mA$ , $V_{O(NOM)} - 1V > V_{IN} > -26V$	6	60	6	60	mV (max)
Load Regulation	$50 mA \leq I_O \leq 1A$	3	50	3	50	mV (max)
Dropout Voltage	$I_O = 0.1A$ , $\Delta V_O \leq 100 mV$	0.1	<b>0.3</b>	0.1	<b>0.3</b>	V (max)
	$I_O = 1A$ , $\Delta V_O \leq 100 mV$	0.6	<b>1</b>	0.6	<b>1</b>	V (max)
Quiescent Current ( $I_q$ )	$I_O \leq 1A$	1	5	1	5	mA (max)
	$I_O = 1A$ , $V_{IN} = V_{O(NOM)}$	9	50	9	50	mA (max)

## Electrical Characteristics (Continued)

$V_{IN} = -5V + V_{O(NOM)}$  (Note 6),  $I_O = 1A$ ,  $C_O = 47 \mu F$ , unless otherwise specified. **Boldface** limits apply over the entire operating temperature range,  $-40^\circ C \leq T_J \leq 125^\circ C$ , all other limits apply for  $T_J = 25^\circ C$ .

Parameter	Conditions	LM2990-12		LM2990-15		Units (Limit)
		Typ (Note 4)	Limit (Note 5)	Typ (Note 4)	Limit (Note 5)	
Short Circuit Current	$R_L = 1\Omega$ (Note 7)	1.2	0.9	1.0	0.75	A (min)
Maximum Output Current	(Note 7)	1.8	1.4	1.8	1.4	A (min)
Ripple Rejection	$V_{ripple} = 1 V_{rms}$ , $f_{ripple} = 1 \text{ kHz}$ , $I_O = 5 \text{ mA}$	52	42	52	42	dB (min)
Output Noise Voltage	10 Hz–100 kHz, $I_O = 5 \text{ mA}$	500	1500	600	1800	$\mu V$ (max)
Long Term Stability	1000 Hours	2000		2000		ppm

**Note 1:** Absolute Maximum Ratings indicate limits beyond which damage to the device may occur. Operating Ratings indicate conditions for which the device is intended to be functional, but do not guarantee specific performance limits. For guaranteed specifications and test conditions, see the Electrical Characteristics.

**Note 2:** Human body model, 100 pF discharged through a 1.5 k $\Omega$  resistor.

**Note 3:** The maximum power dissipation is a function of  $T_{Jmax}$ ,  $\theta_{JA}$ , and  $T_A$ . The maximum allowable power dissipation at any ambient temperature is  $P_D = (T_{Jmax} - T_A)/\theta_{JA}$ . If this dissipation is exceeded, the die temperature will rise above  $125^\circ C$ , and the LM2990 will eventually go into thermal shutdown at a  $T_J$  of approximately  $160^\circ C$ . For the LM2990, the junction-to-ambient thermal resistance, is 53 $^\circ C/W$ , 73 $^\circ C/W$  for the TO-263, and the junction-to-case thermal resistance is 3 $^\circ C$ . If the TO-263 package is used, the thermal resistance can be reduced by increasing the P.C. board copper area thermally connected to the package. Using 0.5 square inches of copper area,  $\theta_{JA}$  is 50 $^\circ C/W$ ; with 1 square inch of copper area,  $\theta_{JA}$  is 37 $^\circ C/W$ ; and with 1.6 or more square inches of copper area,  $\theta_{JA}$  is 32 $^\circ C/W$ .

**Note 4:** Typical values are at  $T_J = 25^\circ C$  and represent the most likely parametric norm.

**Note 5:** Limits are guaranteed and 100% production tested.

**Note 6:**  $V_{O(NOM)}$  is the nominal (typical) regulator output voltage, -5V, -5.2V, -12V or -15V.

**Note 7:** The short circuit current is less than the maximum output current with the -12V and -15V versions due to internal foldback current limiting. The -5V and -5.2V versions, tested with a lower input voltage, does not reach the foldback current limit and therefore conducts a higher short circuit current level. If the LM2990 output is pulled above ground, the maximum allowed current sunk back into the LM2990 is 1.5A.

## Definition of Terms

**Dropout Voltage:** The input-output voltage differential at which the circuit ceases to regulate against further reduction in input voltage. Measured when the output voltage has dropped 100 mV from the nominal value obtained at ( $V_O + 5V$ ) input, dropout voltage is dependent upon load current and junction temperature.

**Input Voltage:** The DC voltage applied to the input terminals with respect to ground.

**Input-Output Differential:** The voltage difference between the unregulated input voltage and the regulated output voltage for which the regulator will operate.

**Line Regulation:** The change in output voltage for a change in the input voltage. The measurement is made under conditions of low dissipation or by using pulse techniques such that the average chip temperature is not significantly affected.

**Load Regulation:** The change in output voltage for a change in load current at constant chip temperature.

**Long Term Stability:** Output voltage stability under accelerated life-test conditions after 1000 hours with maximum rated voltage and junction temperature.

**Output Noise Voltage:** The rms AC voltage at the output, with constant load and no input ripple, measured over a specified frequency range.

**Quiescent Current:** That part of the positive input current that does not contribute to the positive load current. The regulator ground lead current.

**Ripple Rejection:** The ratio of the peak-to-peak input ripple voltage to the peak-to-peak output ripple voltage.

**Temperature Stability of  $V_O$ :** The percentage change in output voltage for a thermal variation from room temperature to either temperature extreme.

# Typical Performance Characteristics

**Dropout Voltage**

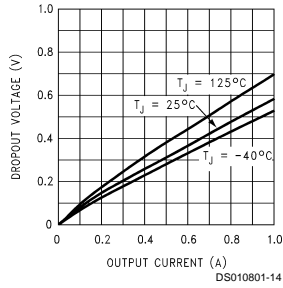

**Normalized Output Voltage**

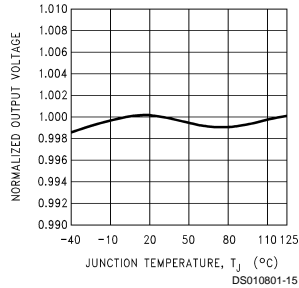

**LM2990-5.0 and LM2990-5.2 Quiescent Current**

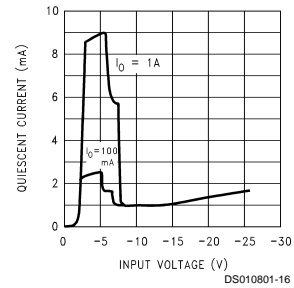

**LM2990-12 Quiescent Current**

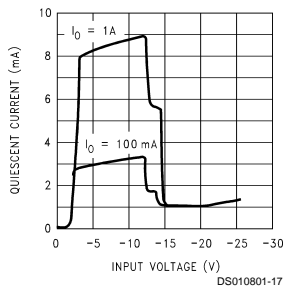

**LM2990-15 Quiescent Current**

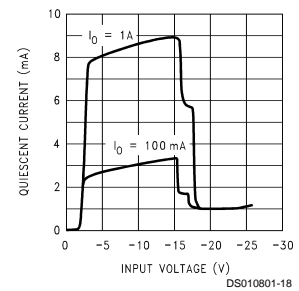

**LM2990-5 and LM2990-5.2 Low Voltage Behavior**

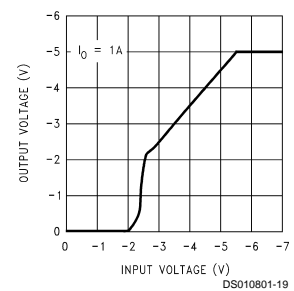

**LM2990-5 and LM2990-5.2 Line Transient Response**

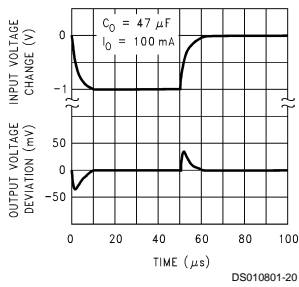

**LM2990-5 and LM2990-5.2 Load Transient Response**

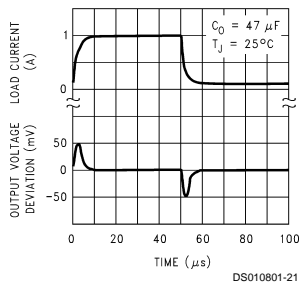

**LM2990-12 and LM2990-15 Low Voltage Behavior**

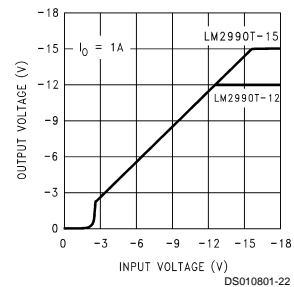

**LM2990-12 and LM2990-15 Line Transient Response**

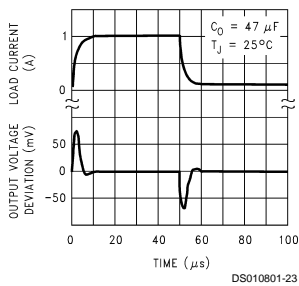

**LM2990-12 and LM2990-15 Load Transient Response**

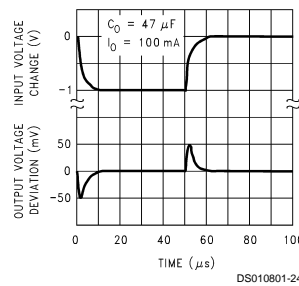

## Typical Performance Characteristics (Continued)

**LM2990-5 and LM2990-5.2  
Ripple Rejection**

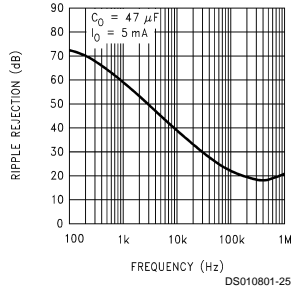

**LM2990-5 and LM2990-5.2  
Output Impedance**

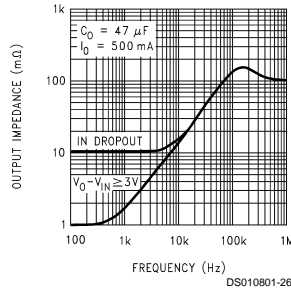

**Maximum Output Current**

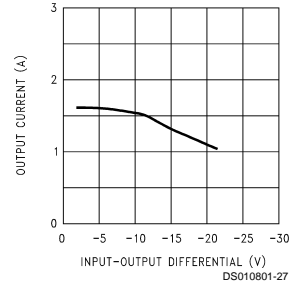

**LM2990-12 and LM2990-15  
Ripple Rejection**

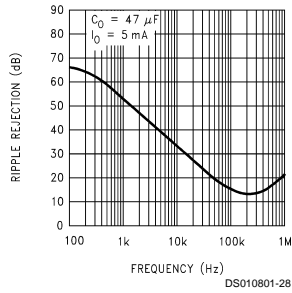

**LM2990-12 and LM2990-15  
Output Impedance**

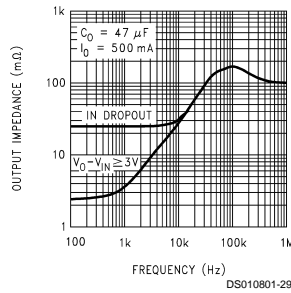

**Maximum Output Current**

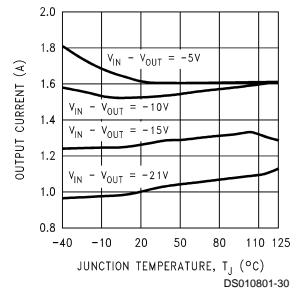

**Maximum Power  
Dissipation (TO-220)**

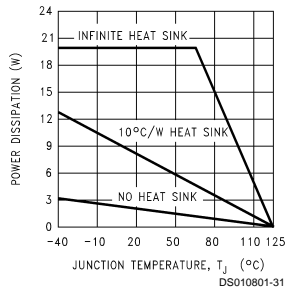

**Maximum Power Dissipation  
(TO-263) (See (Note 3))**

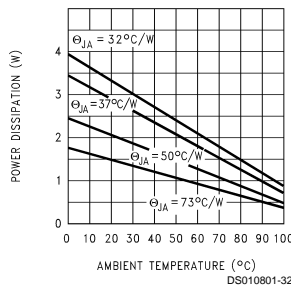

## Typical Applications

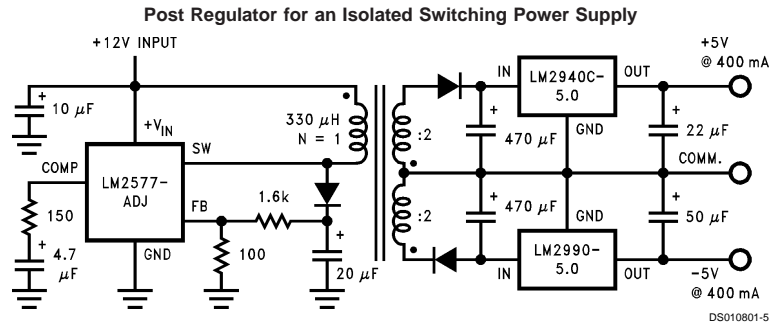

The LM2940 is a positive 1A low dropout regulator; refer to its datasheet for further information.

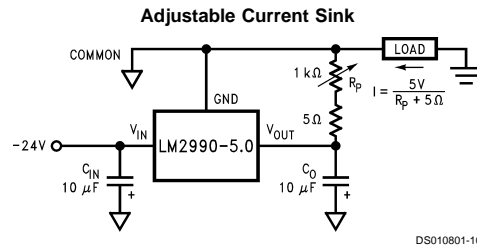
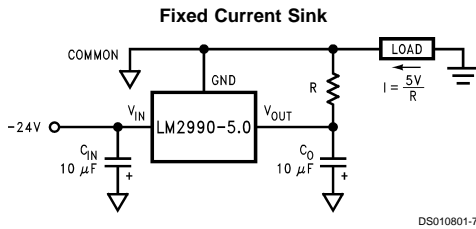

## Application Hints

### EXTERNAL CAPACITORS

The LM2990 regulator requires an output capacitor to maintain stability. The capacitor must be at least 10 µF aluminum electrolytic or 1 µF solid tantalum. The output capacitor's ESR must be less than 10Ω, or the zero added to the regulator frequency response by the ESR could reduce the phase margin, creating oscillations (refer to the graph on the right). An input capacitor, of at least 1 µF solid tantalum or 10 µF aluminum electrolytic, is also needed if the regulator is situated more than 6" from the input power supply filter.

### FORCING THE OUTPUT POSITIVE

Due to an internal clamp circuit, the LM2990 can withstand positive voltages on its output. If the voltage source pulling the output positive is DC, the current must be limited to 1.5A. A current over 1.5A fed back into the LM2990 could damage the device. The LM2990 output can also withstand fast positive voltage transients up to 26V, without any current limiting of the source. However, if the transients have a duration of over 1 ms, the output should be clamped with a Schottky diode to ground.

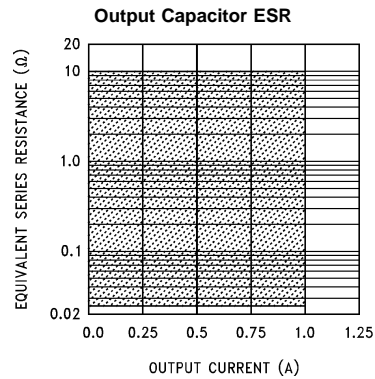





**Physical Dimensions** inches (millimeters) unless otherwise noted

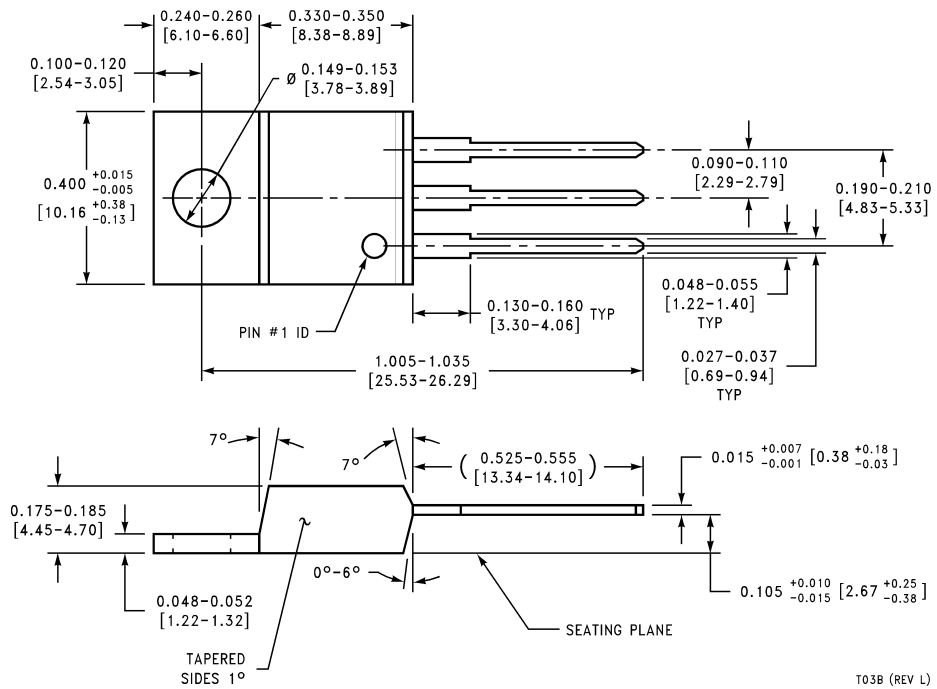

**TO-220 3-Lead Molded Package**  
**Order Number LM2990T-5.0, LM2990T-5.2, LM2990T-12 or LM2990T-15**  
**NS Package Number T03B**

T03B (REV L)

**Physical Dimensions** inches (millimeters) unless otherwise noted (Continued)

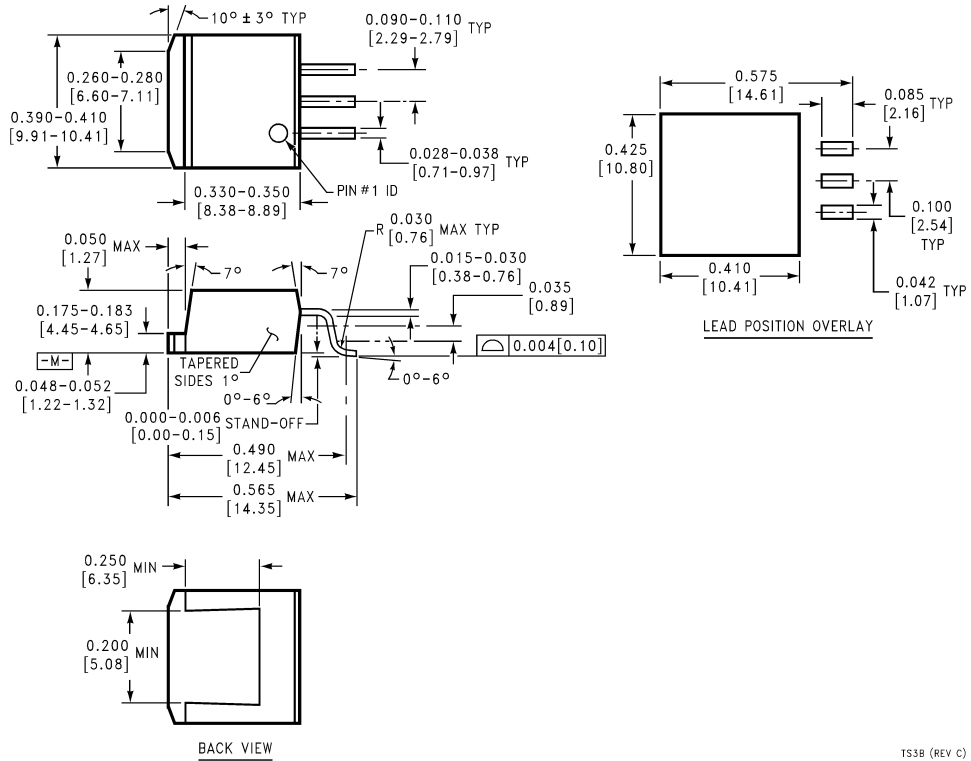

TS3B (REV C)

**TO-263 3-Lead Plastic Surface Mount Package**  
**Order Number LM2990S-5.0, LM2990S-12 or LM2990S-15**  
**NS Package Number TS3B**

**Physical Dimensions** inches (millimeters) unless otherwise noted (Continued)

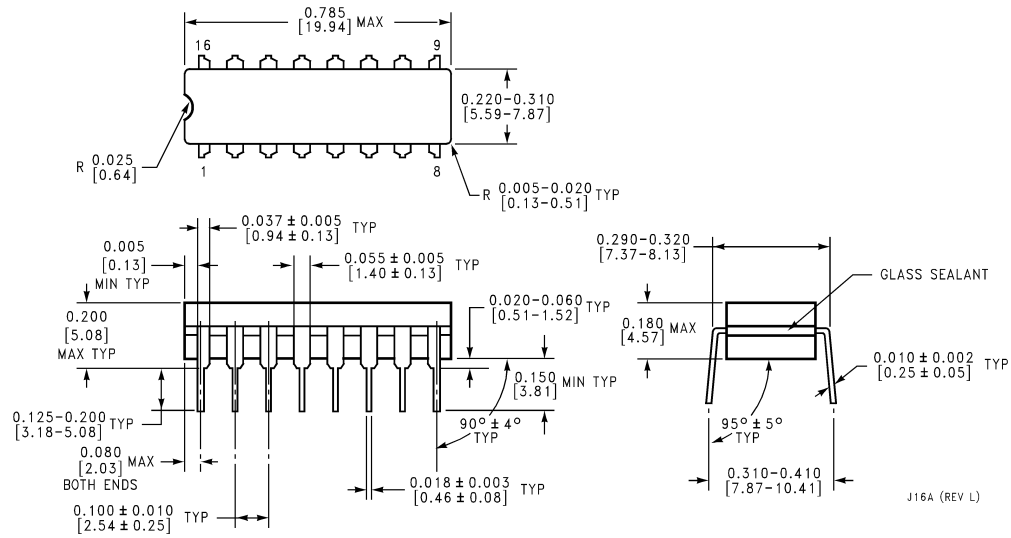

**16-Lead Ceramic Dual-in-Line Package**  
**LM2990J-5.0-QML (5962-9571101QEA), LM2990J-12-QML (5962-9571001QEA), or LM2990J-15-QML (5962-9570901QEA),**  
**NS Package Number J16A**

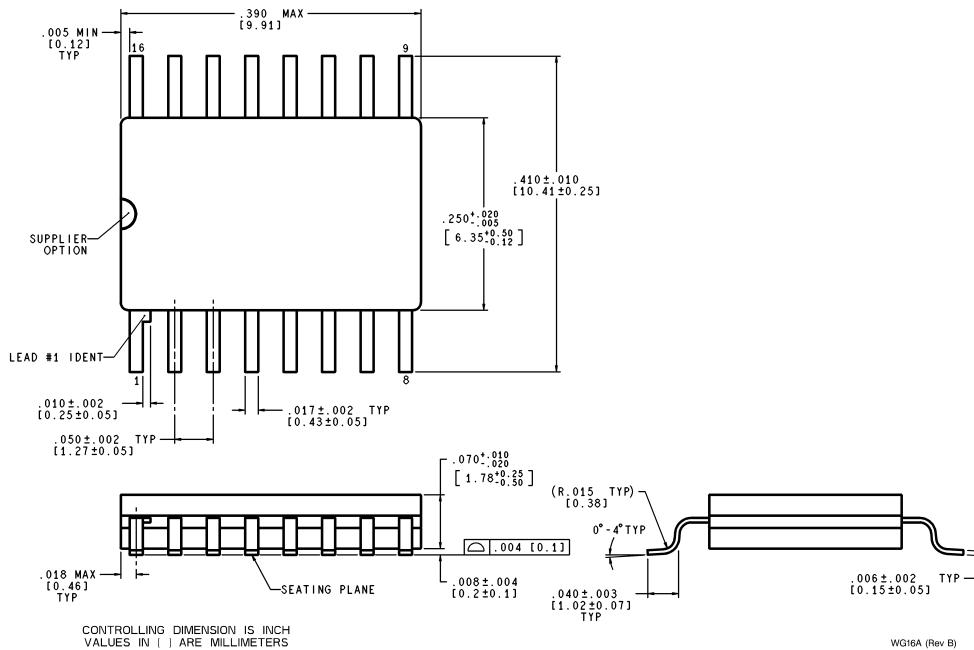

**16-Lead Ceramic Surface-Mount Package**  
**LM2990WG5.0-QML (5962-9571101QXA)**  
**NS Package Number WG16A**

## Notes

### LIFE SUPPORT POLICY

NATIONAL'S PRODUCTS ARE NOT AUTHORIZED FOR USE AS CRITICAL COMPONENTS IN LIFE SUPPORT DEVICES OR SYSTEMS WITHOUT THE EXPRESS WRITTEN APPROVAL OF THE PRESIDENT AND GENERAL COUNSEL OF NATIONAL SEMICONDUCTOR CORPORATION. As used herein:

1. Life support devices or systems are devices or systems which, (a) are intended for surgical implant into the body, or (b) support or sustain life, and whose failure to perform when properly used in accordance with instructions for use provided in the labeling, can be reasonably expected to result in a significant injury to the user.
2. A critical component is any component of a life support device or system whose failure to perform can be reasonably expected to cause the failure of the life support device or system, or to affect its safety or effectiveness.



**National Semiconductor Corporation**  
Americas  
Tel: 1-800-272-9959  
Fax: 1-800-737-7018  
Email: support@nsc.com

[www.national.com](http://www.national.com)

**National Semiconductor Europe**  
Fax: +49 (0) 1 80-530 85 86  
Email: europe.support@nsc.com  
Deutsch Tel: +49 (0) 1 80-530 85 85  
English Tel: +49 (0) 1 80-532 78 32  
Français Tel: +49 (0) 1 80-532 93 58  
Italiano Tel: +49 (0) 1 80-534 16 80

**National Semiconductor Asia Pacific Customer Response Group**  
Tel: 65-2544466  
Fax: 65-2504466  
Email: sea.support@nsc.com

**National Semiconductor Japan Ltd.**  
Tel: 81-3-5639-7560  
Fax: 81-3-5639-7507