

ADC121S101/ADC101S101/ADC081S101 1MSPS, 12-/10-/8-Bit A/D Converters in SOT-23 & LLP

General Description

The ADC121S101, ADC101S101, and ADC081S101 are low power, monolithic CMOS 12-, 10- and 8-bit analog-to-digital converters that operate at 1 MSPS. Each device is based on a successive approximation register architecture with internal track-and-hold. The serial interface is compatible with several standards, such as SPI™, QSPI™, MICROWIRE™, and many common DSP serial interfaces.

The ADC121S101/101S101/081S101 uses the supply voltage as a reference. This enables the devices to operate with a full-scale input range of 0 to V_{DD} . The conversion rate is determined from the serial clock (SCLK) speed. These converters offer a shutdown mode, which can be used to trade throughput for power consumption. The ADC121S101/101S101/081S101 are operated with a single supply that can range from +2.7V to +5.25V. Normal power consumption during continuous conversion, using a +3V or +5V supply, is 2 mW or 10 mW, respectively. The power down feature, which is enabled by a chip select (\overline{CS}) pin, reduces the power consumption to under 5 μ W using a +5V supply. All three converters are available in a 6-lead SOT-23 package, which provides an extremely small footprint for applications where space is a critical consideration. The ADC081S101 is also available in a 6-lead LLP package. These products are designed for operation over the industrial temperature range of -40°C to $+85^{\circ}\text{C}$, with some parameters specified to $+125^{\circ}\text{C}$ for the ADC121S101.

Features

- Variable power management
- Packaged in 6-lead SOT-23 (ADC081S101 also available in a 6-Lead LLP package)
- Power supply used as reference
- Single +2.7V to +5.25V supply operation
- SPI™/QSPI™/MICROWIRE™/DSP compatible

Key Specifications

- | | |
|------------------------------------|----------------------|
| ■ Resolution with no Missing Codes | 12/10/8 bits |
| ■ Conversion Rate | 1 MSPS |
| ■ DNL (ADC121S101) | +0.5, -0.3 LSB (typ) |
| ■ INL (ADC121S101) | ± 0.4 LSB (typ) |
| ■ Power Consumption | |
| — 3V Supply | 2 mW (typ) |
| — 5V Supply | 10 mW (typ) |

Applications

- Automotive Navigation
- FA/ATM Equipment
- Portable Systems
- Medical Instruments
- Mobile Communications
- Instrumentation and Control Systems

Connection Diagram

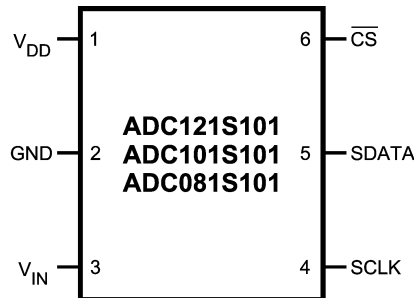

20110201

MICROWIRE™ is a trademark of National Semiconductor Corporation.
 TRI-STATE® is a trademark of National Semiconductor Corporation.
 QSPI™ and SPI™ are trademarks of Motorola, Inc.

Ordering Information

Order Code	Temperature Range	Description	Top Mark
ADC121S101CIMF	-40°C to +125°C	6-Lead SOT-23 Package	X01C
ADC101S101CIMF	-40°C to +85°C	6-Lead SOT-23 Package	X02C
ADC081S101CIMF	-40°C to +85°C	6-Lead SOT-23 Package	X03C
ADC121S101CIMFX	-40°C to +125°C	6-Lead SOT-23 Package, Tape & Reel	X01C
ADC101S101CIMFX	-40°C to +85°C	6-Lead SOT-23 Package, Tape & Reel	X02C
ADC081S101CIMFX	-40°C to +85°C	6-Lead SOT-23 Package, Tape & Reel	X03C
ADC081S101CISDX	-40°C to +85°C	6-Lead LLP Package, Tape & Reel	X3C
ADC081S101CISD	-40°C to +85°C	6-Lead LLP Package, Tape & Partial Reel	X3C
ADC121S101EVAL		SOT-23 Evaluation Board	
ADC101S101EVAL		SOT-23 Evaluation Board	
ADC081S101EVAL		SOT-23 Evaluation Board	

Pin Descriptions

Pin No.	Symbol	Description
ANALOG I/O		
3	V_{IN}	Analog input. This signal can range from 0V to V_{DD} .
DIGITAL I/O		
4	SCLK	Digital clock input. The range of frequencies for this input is 10 kHz to 20 MHz, with guaranteed performance at 20 MHz. This clock directly controls the conversion and readout processes.
5	SDATA	Digital data output. The output words are clocked out of this pin by the SCLK pin.
6	\overline{CS}	Chip select. A conversion process begins on the falling edge of \overline{CS} .
POWER SUPPLY		
1	V_{DD}	Positive supply pin. These pins should be connected to a quiet +2.7V to +5.25V source and bypassed to GND with 0.1 μ F and 1 μ F monolithic capacitors located within 1 cm of the power pin. The ADC121S101/101S101/081S101 uses this power supply as a reference, so it should be thoroughly bypassed.
2	GND	The ground return for the supply.

Block Diagram

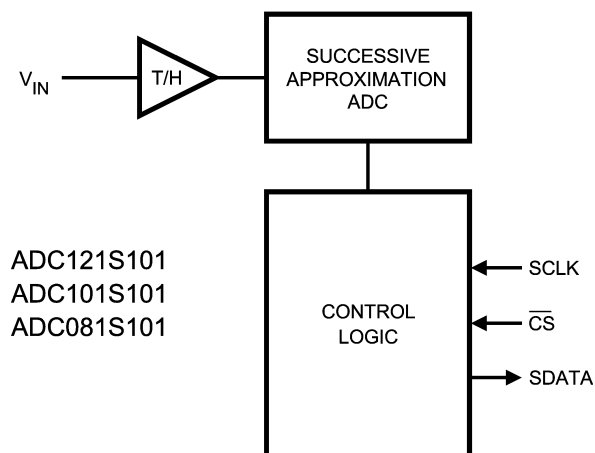

20110218

Absolute Maximum Ratings

(Notes 1, 2)

If Military/Aerospace specified devices are required, please contact the National Semiconductor Sales Office/Distributors for availability and specifications.

Supply Voltage V_{DD}	-0.3V to +6.5V
Voltage on Any Analog Pin to GND	-0.3V to $V_{DD} + 0.3V$
Voltage on Any Digital Pin to GND	-0.3V to 6.5V
Input Current at Any Pin (Note 5)	± 10 mA
ESD Susceptibility	
Human Body Model	3500V
Machine Model	200V
Soldering Temperature, Infrared,	
10 seconds	215°C
Junction Temperature	+150°C
Storage Temperature	-65°C to +150°C

Soldering process must comply with National Semiconductor's Reflow Temperature Profile specifications. Refer to www.national.com/packaging.

(Note 4)

Operating Ratings (Note 2)

Operating Temperature Range	
ADC121S101	$-40^{\circ}\text{C} \leq T_A \leq +125^{\circ}\text{C}$
ADC101S101 & ADC081S101	$-40^{\circ}\text{C} \leq T_A \leq +85^{\circ}\text{C}$
V_{DD} Supply Voltage	+2.7V to +5.25V
Digital Input Pins Voltage Range	
(Note 6)	+2.7V to +5.25V

Package Thermal Resistance

Package	θ_{JA}
6-Lead SOT-23	265°C / W
6-Lead LLP	94°C / W

ADC121S101 Converter Electrical Characteristics

The following specifications apply for $V_{DD} = +2.7V$ to 5.25V, $f_{SCLK} = 20$ MHz, $f_{SAMPLE} = 1$ MSPS unless otherwise noted. **Bold-face limits apply for $T_A = -40^{\circ}\text{C}$ to $+85^{\circ}\text{C}$** ; all other limits $T_A = 25^{\circ}\text{C}$, unless otherwise noted.

Symbol	Parameter	Conditions	Typical	Limits	Units
STATIC CONVERTER CHARACTERISTICS ($V_{DD} = 2.7V$ to 3.6V)					
	Resolution with No Missing Codes	$-40^{\circ}\text{C} \leq T_A \leq 125^{\circ}\text{C}$		12	Bits
INL	Integral Non-Linearity	$-40^{\circ}\text{C} \leq T_A \leq 85^{\circ}\text{C}$	± 0.4	± 1	LSB (max)
		$T_A = 125^{\circ}\text{C}$		+1 -1.1	LSB (min) LSB (max)
DNL	Differential Non-Linearity	$-40^{\circ}\text{C} \leq T_A \leq 85^{\circ}\text{C}$	+0.5 -0.3	+1 -0.9	LSB (max) LSB (min)
		$T_A = 125^{\circ}\text{C}$		± 1	LSB (max)
V_{OFF}	Offset Error	$-40^{\circ}\text{C} \leq T_A \leq 125^{\circ}\text{C}$	± 0.1	± 1.2	LSB (max)
GE	Gain Error	$-40^{\circ}\text{C} \leq T_A \leq 125^{\circ}\text{C}$	± 0.2	± 1.2	LSB (max)
DYNAMIC CONVERTER CHARACTERISTICS ($f_{IN} = 100$ kHz, -0.02 dBFS sine wave unless otherwise noted)					
SINAD	Signal-to-Noise Plus Distortion Ratio	$-40^{\circ}\text{C} \leq T_A \leq 125^{\circ}\text{C}$	72	70	dB (min)
SNR	Signal-to-Noise Ratio	$-40^{\circ}\text{C} \leq T_A \leq 85^{\circ}\text{C}$	72.5	70.8	dB (min)
		$T_A = 125^{\circ}\text{C}$		70.6	dB (min)
THD	Total Harmonic Distortion		-80		dB
SFDR	Spurious-Free Dynamic Range		82		dB
IMD	Intermodulation Distortion, Second Order Terms	$f_a = 103.5$ kHz, $f_b = 113.5$ kHz	-78		dB
	Intermodulation Distortion, Third Order Terms	$f_a = 103.5$ kHz, $f_b = 113.5$ kHz	-78		dB
FPBW	-3 dB Full Power Bandwidth	+5V Supply	11		MHz
		+3V Supply	8		MHz
POWER SUPPLY CHARACTERISTICS					
V_{DD}	Supply Voltage	$-40^{\circ}\text{C} \leq T_A \leq 125^{\circ}\text{C}$		2.7	V (min)
				5.25	V (max)

ADC121S101 Converter Electrical Characteristics (Continued)

The following specifications apply for $V_{DD} = +2.7V$ to $+5.25V$, $f_{SCLK} = 20$ MHz, $f_{SAMPLE} = 1$ MSPS unless otherwise noted. **Bold-face limits apply for $T_A = -40^\circ C$ to $+85^\circ C$** ; all other limits $T_A = 25^\circ C$, unless otherwise noted.

Symbol	Parameter	Conditions	Typical	Limits	Units
POWER SUPPLY CHARACTERISTICS					
I_{DD}	Normal Mode (Static)	$V_{DD} = +4.75V$ to $+5.25V$, SCLK On or Off	2		mA
		$V_{DD} = +2.7V$ to $+3.6V$, SCLK On or Off	1		mA
	Normal Mode (Operational)	$V_{DD} = +4.75V$ to $+5.25V$, $f_{SAMPLE} = 1$ MSPS	2.0	3.2	mA (max)
		$V_{DD} = +2.7V$ to $+3.6V$, $f_{SAMPLE} = 1$ MSPS	0.6	1.5	mA (max)
	Shutdown Mode	$V_{DD} = +5V$, SCLK Off	0.5		μA
		$V_{DD} = +5V$, SCLK On	60		μA
P_D	Power Consumption, Normal Mode (Operational)	$V_{DD} = +5V$, $f_{SAMPLE} = 1$ MSPS	10	16	mW (max)
		$V_{DD} = +3V$, $f_{SAMPLE} = 1$ MSPS	2	4.5	mW (max)
	Power Consumption, Shutdown Mode	$V_{DD} = +5V$, SCLK Off	2.5		μW
		$V_{DD} = +3V$, SCLK Off	1.5		μW
ANALOG INPUT CHARACTERISTICS					
V_{IN}	Input Range		0 to V_{DD}		V
I_{DCL}	DC Leakage Current			± 1	μA (max)
C_{INA}	Input Capacitance (Note 3)		30		pF
DIGITAL INPUT CHARACTERISTICS					
V_{IH}	Input High Voltage			2.4	V (min)
V_{IL}	Input Low Voltage	$V_{DD} = +5V$		0.8	V (max)
		$V_{DD} = +3V$		0.4	V (max)
I_{IN}	Input Current	$V_{IN} = 0V$ or V_{DD}	± 10 nA	± 1	μA (max)
C_{IND}	Input Capacitance (Note 3)		2	4	pF (max)
DIGITAL OUTPUT CHARACTERISTICS					
V_{OH}	Output High Voltage	$I_{SOURCE} = 200 \mu A$, $V_{DD} = +2.7V$ to $+5.25V$		$V_{DD} - 0.2$	V (min)
V_{OL}	Output Low Voltage	$I_{SINK} = 200 \mu A$		0.4	V (max)
I_{OL}	TRI-STATE Leakage Current			± 10	μA (max)
C_{OUT}	TRI-STATE Output Capacitance		2	4	pF (max)
	Output Coding		Straight (Natural) Binary		
AC ELECTRICAL CHARACTERISTICS					
f_{SCLK}	Clock Frequency			20	MHz (max)
DC	SCLK Duty Cycle			40	% (min)
				60	% (max)
t_{TH}	Track/Hold Acquisition Time			400	ns (max)
f_{RATE}	Throughput Rate	See Serial Interface Section		1	MSPS (max)
t_{AD}	Aperture Delay		3		ns
t_{AJ}	Aperture Jitter		30		ps

ADC101S101 Converter Electrical Characteristics

The following specifications apply for $V_{DD} = +2.7V$ to $5.25V$, $f_{SCLK} = 20$ MHz, $f_{SAMPLE} = 1$ MSPS unless otherwise noted. **Bold-face limits apply for $T_A = -40^\circ C$ to $+85^\circ C$** ; all other limits $T_A = 25^\circ C$, unless otherwise noted.

Symbol	Parameter	Conditions	Typical	Limits	Units
STATIC CONVERTER CHARACTERISTICS					
	Resolution with No Missing Codes			10	Bits
INL	Integral Non-Linearity		± 0.2	± 0.7	LSB (max)
DNL	Differential Non-Linearity		+0.3 -0.2	± 0.7	LSB (max) LSB (max)
V_{OFF}	Offset Error		± 0.1	± 0.7	LSB (max)
GE	Gain Error		± 0.2	± 1	LSB (max)
DYNAMIC CONVERTER CHARACTERISTICS					
SINAD	Signal-to-Noise Plus Distortion Ratio	$f_{IN} = 100$ kHz	61.7	61	dBFS (min)
SNR	Signal-to-Noise Ratio	$f_{IN} = 100$ kHz	62		dB
THD	Total Harmonic Distortion	$f_{IN} = 100$ kHz	-77	-73	dB (max)
SFDR	Spurious-Free Dynamic Range	$f_{IN} = 100$ kHz	78	74	dB (min)
IMD	Intermodulation Distortion, Second Order Terms	$f_a = 103.5$ kHz, $f_b = 113.5$ kHz	-78		dB
	Intermodulation Distortion, Third Order Terms	$f_a = 103.5$ kHz, $f_b = 113.5$ kHz	-78		dB
FPBW	-3 dB Full Power Bandwidth	+5V Supply	11		MHz
		+3V Supply	8		MHz
POWER SUPPLY CHARACTERISTICS					
V_{DD}	Supply Voltage			2.7 5.25	V (min) V (max)
I_{DD}	Normal Mode (Static)	$V_{DD} = +4.75V$ to $+5.25V$, SCLK On or Off	2		mA
		$V_{DD} = +2.7V$ to $+3.6V$, SCLK On or Off	1		mA
	Normal Mode (Operational)	$V_{DD} = +4.75V$ to $+5.25V$, $f_{SAMPLE} = 1$ MSPS	2.0	3.2	mA (max)
		$V_{DD} = +2.7V$ to $+3.6V$, $f_{SAMPLE} = 1$ MSPS	0.6	1.5	mA (max)
Shutdown Mode	$V_{DD} = +5V$, SCLK Off	0.5		μA (max)	
	$V_{DD} = +5V$, SCLK On	60		μA (max)	
P_D	Power Consumption, Normal Mode (Operational)	$V_{DD} = +5V$, $f_{SAMPLE} = 1$ MSPS	10	16	mW (max)
		$V_{DD} = +3V$, $f_{SAMPLE} = 1$ MSPS	2	4.5	mW (max)
	Power Consumption, Shutdown Mode	$V_{DD} = +5V$, SCLK Off	2.5		μW (max)
		$V_{DD} = +3V$, SCLK Off	1.5		μW (max)
ANALOG INPUT CHARACTERISTICS					
V_{IN}	Input Range		0 to V_{DD}		V
I_{DCL}	DC Leakage Current			± 1	μA (max)
C_{INA}	Input Capacitance (Note 3)		30		pF
DIGITAL INPUT CHARACTERISTICS					
V_{IH}	Input High Voltage			2.4	V (min)
V_{IL}	Input Low Voltage	$V_{DD} = +5V$		0.8	V (max)
		$V_{DD} = +3V$		0.4	V (max)
I_{IN}	Input Current	$V_{IN} = 0V$ or V_{DD}	± 10 nA	± 1	μA (max)
C_{IND}	Input Capacitance (Note 3)		2	4	pF (max)
DIGITAL OUTPUT CHARACTERISTICS					
V_{OH}	Output High Voltage	$I_{SOURCE} = 200 \mu A$, $V_{DD} = +2.7V$ to $+5.25V$		$V_{DD} - 0.2$	V (min)

ADC101S101 Converter Electrical Characteristics (Continued)

The following specifications apply for $V_{DD} = +2.7V$ to $5.25V$, $f_{SCLK} = 20$ MHz, $f_{SAMPLE} = 1$ MSPS unless otherwise noted. **Bold-face limits apply for $T_A = -40^{\circ}C$ to $+85^{\circ}C$** ; all other limits $T_A = 25^{\circ}C$, unless otherwise noted.

Symbol	Parameter	Conditions	Typical	Limits	Units
DIGITAL OUTPUT CHARACTERISTICS					
V_{OL}	Output Low Voltage	$I_{SINK} = 200 \mu A$		0.4	V (max)
I_{OL}	TRI-STATE Leakage Current			± 10	μA (max)
C_{OUT}	TRI-STATE Output Capacitance (Note 3)		2	4	pF (max)
	Output Coding		Straight (Natural) Binary		
AC ELECTRICAL CHARACTERISTICS					
f_{SCLK}	Clock Frequency			20	MHz (max)
DC	SCLK Duty Cycle			40 60	% (min) % (max)
t_{TH}	Track/Hold Acquisition Time			400	ns (max)
f_{RATE}	Throughput Rate	See Serial Interface Section		1	MSPS (max)
t_{AD}	Aperture Delay		3		ns
t_{AJ}	Aperture Jitter		30		ps

ADC081S101 Converter Electrical Characteristics

The following specifications apply for $V_{DD} = +2.7V$ to $5.25V$, $f_{SCLK} = 20$ MHz, $f_{SAMPLE} = 1$ MSPS unless otherwise noted. **Bold-face limits apply for $T_A = -40^{\circ}C$ to $+85^{\circ}C$** ; all other limits $T_A = 25^{\circ}C$, unless otherwise noted.

Symbol	Parameter	Conditions	Typical	Limits	Units	
STATIC CONVERTER CHARACTERISTICS						
	Resolution with No Missing Codes			8	Bits	
INL	Integral Non-Linearity		± 0.05	± 0.3	LSB (max)	
DNL	Differential Non-Linearity		± 0.07	± 0.3	LSB (max)	
V_{OFF}	Offset Error		± 0.03	± 0.3	LSB (max)	
GE	Gain Error		± 0.08	± 0.4	LSB (max)	
	Total Unadjusted Error		± 0.07	± 0.3	LSB (max)	
DYNAMIC CONVERTER CHARACTERISTICS						
SINAD	Signal-to-Noise Plus Distortion Ratio	$f_{IN} = 100$ kHz	49.7	49	dB (min)	
SNR	Signal-to-Noise Ratio	$f_{IN} = 100$ kHz	49.7		dB	
THD	Total Harmonic Distortion	$f_{IN} = 100$ kHz	-77	-65	dB (max)	
SFDR	Spurious-Free Dynamic Range	$f_{IN} = 100$ kHz	69	65	dB (min)	
IMD	Intermodulation Distortion, Second Order Terms	$f_a = 103.5$ kHz, $f_b = 113.5$ kHz	-68		dB	
	Intermodulation Distortion, Third Order Terms	$f_a = 103.5$ kHz, $f_b = 113.5$ kHz	-68		dB	
FPBW	-3 dB Full Power Bandwidth	+5V Supply	11		MHz	
		+3V Supply	8		MHz	
POWER SUPPLY CHARACTERISTICS						
V_{DD}	Supply Voltage			2.7 5.25	V (min) V (max)	
I_{DD}	Normal Mode (Static)	$V_{DD} = +4.75V$ to $+5.25V$, SCLK On or Off	2		mA	
		$V_{DD} = +2.7V$ to $+3.6V$, SCLK On or Off	1		mA	
	Normal Mode (Operational)	$V_{DD} = +4.75V$ to $+5.25V$, $f_{SAMPLE} = 1$ MSPS	SOT-23 LLP	2.0	3.2 2.6	mA (max)
		$V_{DD} = +2.7V$ to $+3.6V$, $f_{SAMPLE} = 1$ MSPS	SOT-23 LLP	0.6	1.5 1.1	mA (max)
	Shutdown Mode	$V_{DD} = +5V$, SCLK Off		0.5		μA (max)
		$V_{DD} = +5V$, SCLK On		60		μA (max)
P_D	Power Consumption, Normal Mode (Operational)	$V_{DD} = +5V$, $f_{SAMPLE} = 1$ MSPS	SOT-23 LLP	10	16 13	mW (max)
		$V_{DD} = +3V$, $f_{SAMPLE} = 1$ MSPS		2	4.5	mW (max)
	Power Consumption, Shutdown Mode	$V_{DD} = +5V$, SCLK Off		2.5		μW (max)
		$V_{DD} = +3V$, SCLK Off		1.5		μW (max)
ANALOG INPUT CHARACTERISTICS						
V_{IN}	Input Range		0 to V_{DD}		V	
I_{DCL}	DC Leakage Current			± 1	μA (max)	
C_{INA}	Input Capacitance		30		pF	
DIGITAL INPUT CHARACTERISTICS						
V_{IH}	Input High Voltage			2.4	V (min)	
V_{IL}	Input Low Voltage	$V_{DD} = +5V$		0.8	V (max)	
		$V_{DD} = +3V$		0.4	V (max)	
I_{IN}	Digital Input Current	$V_{IN} = 0V$ or V_{DD}	± 10 nA	± 1	μA (max)	
C_{IND}	Input Capacitance(Note 3)		2	4	pF (max)	

ADC081S101 Converter Electrical Characteristics (Continued)

The following specifications apply for $V_{DD} = +2.7V$ to $5.25V$, $f_{SCLK} = 20$ MHz, $f_{SAMPLE} = 1$ MSPS unless otherwise noted. **Bold-face limits apply for $T_A = -40^\circ C$ to $+85^\circ C$** ; all other limits $T_A = 25^\circ C$, unless otherwise noted.

Symbol	Parameter	Conditions	Typical	Limits	Units
DIGITAL OUTPUT CHARACTERISTICS					
V_{OH}	Output High Voltage	$I_{SOURCE} = 200 \mu A$, $V_{DD} = +2.7V$ to $+5.25V$		$V_{DD} - 0.2$	V (min)
V_{OL}	Output Low Voltage	$I_{SINK} = 200 \mu A$		0.4	V (max)
I_{OL}	TRI-STATE Leakage Current			± 10	μA (max)
C_{OUT}	TRI-STATE Output Capacitance (Note 3)		2	4	pF (max)
	Output Coding		Straight (Natural) Binary		
AC ELECTRICAL CHARACTERISTICS					
f_{SCLK}	Clock Frequency			20	MHz (max)
DC	SCLK Duty Cycle			40 60	% (min) % (max)
t_{TH}	Track/Hold Acquisition Time			400	ns (max)
f_{RATE}	Throughput Rate	See Applications Section		1	MSPS (min)
t_{AD}	Aperture Delay		3		ns
t_{AJ}	Aperture Jitter		30		ps

ADC121S101/ADC101S101/ADC081S101 Timing Specifications

The following specifications apply for $V_{DD} = +2.7V$ to $5.25V$, $f_{SCLK} = 20$ MHz, **Boldface limits apply for $T_A = -40^\circ C$ to $+85^\circ C$** ; all other limits $T_A = 25^\circ C$, unless otherwise noted. (Note 11)

Symbol	Parameter	Conditions	Typical	Limits	Units
$t_{CONVERT}$			$16 \times t_{SCLK}$		
t_{QUIET}	(Note 7)			50	ns (min)
t_1	Minimum \overline{CS} Pulse Width			10	ns (min)
t_2	\overline{CS} to SCLK Setup Time			10	ns (min)
t_3	Delay from \overline{CS} Until SDATA TRI-STATE® Disabled (Note 8)			20	ns (max)
t_4	Data Access Time after SCLK Falling Edge (Note 9)	$V_{DD} = +2.7$ to $+3.6$		40	ns (max)
		$V_{DD} = +4.75$ to $+5.25$		20	ns (max)
t_5	SCLK Low Pulse Width			0.4 x t_{SCLK}	ns (min)
t_6	SCLK High Pulse Width			0.4 x t_{SCLK}	ns (min)
t_7	SCLK to Data Valid Hold Time	$V_{DD} = +2.7$ to $+3.6$		7	ns (min)
		$V_{DD} = +4.75$ to $+5.25$		5	ns (min)
t_8	SCLK Falling Edge to SDATA High Impedance (Note 10)	$V_{DD} = +2.7$ to $+3.6$		25	ns (max)
		$V_{DD} = +4.75$ to $+5.25$		6	ns (min)
t_8	SCLK Falling Edge to SDATA High Impedance (Note 10)	$V_{DD} = +2.7$ to $+3.6$		25	ns (max)
		$V_{DD} = +4.75$ to $+5.25$		5	ns (min)
$t_{POWER-UP}$	Power-Up Time from Full Power-Down		1		μs

Note 1: Absolute maximum ratings are limiting values, to be applied individually, and beyond which the serviceability of the circuit may be impaired. Functional operability under any of these conditions is not implied. Exposure to maximum ratings for extended periods may affect device reliability.

Note 2: All voltages are measured with respect to GND = 0V, unless otherwise specified

Note 3: Specification limit guaranteed by design.

Note 4: See the section titled "Surface Mount" found in a current National Semiconductor Linear Databook for other methods of soldering surface mount devices.

Note 5: Except power supply pins.

Note 6: Independent of supply voltage.

Note 7: Minimum Quiet Time Required Between Bus Relinquish and Start of Next Conversion

Note 8: Measured with the load circuit shown above, and defined as the time taken by the output to cross 1.0V.

Note 9: Measured with the load circuit shown above, and defined as the time taken by the output to cross 1.0V or 2.0V.

Note 10: t_8 is derived from the time taken by the outputs to change by 0.5V with the loading circuit shown above. The measured number is then adjusted to remove the effects of charging or discharging the 25pF capacitor. This means t_8 is the true bus relinquish time, independent of the bus loading.

Note 11: All input signals are specified as $t_r = t_f = 5$ ns (10% to 90% V_{DD}) and timed from 1.6V.

Specification Definitions

APERTURE DELAY is the time after the falling edge of \overline{CS} to when the input signal is acquired or held for conversion.

APERTURE JITTER (APERTURE UNCERTAINTY) is the variation in aperture delay from sample to sample. Aperture jitter manifests itself as noise in the output.

DIFFERENTIAL NON-LINEARITY (DNL) is the measure of the maximum deviation from the ideal step size of 1 LSB.

DUTY CYCLE is the ratio of the time that a repetitive digital waveform is high to the total time of one period. The specification here refers to the SCLK.

EFFECTIVE NUMBER OF BITS (ENOB, or EFFECTIVE BITS) is another method of specifying Signal-to-Noise and Distortion or SINAD. ENOB is defined as $(\text{SINAD} - 1.76) / 6.02$ and says that the converter is equivalent to a perfect ADC of this (ENOB) number of bits.

FULL POWER BANDWIDTH is a measure of the frequency at which the reconstructed output fundamental drops 3 dB below its low frequency value for a full scale input.

GAIN ERROR is the deviation of the last code transition (111...110) to (111...111) from the ideal ($V_{REF} - 1.5$ LSB for ADC121S101 and ADC101S101, $V_{REF} - 1$ LSB for ADC081S101), after adjusting for offset error.

INTEGRAL NON-LINEARITY (INL) is a measure of the deviation of each individual code from a line drawn from negative full scale ($1/2$ LSB below the first code transition) through positive full scale ($1/2$ LSB above the last code transition). The deviation of any given code from this straight line is measured from the center of that code value.

INTERMODULATION DISTORTION (IMD) is the creation of additional spectral components as a result of two sinusoidal frequencies being applied to the ADC input at the same time. It is defined as the ratio of the power in either the two second order or all four third order intermodulation products to the sum of the power in both of the original frequencies. IMD is usually expressed in dBFS.

MISSING CODES are those output codes that will never appear at the ADC outputs. The ADC121S101/101S101/081S101 is guaranteed not to have any missing codes.

OFFSET ERROR is the deviation of the first code transition (000...000) to (000...001) from the ideal (i.e. GND + 0.5 LSB for the ADC121S101 and ADC101S101, and GND + 1 LSB for the ADC081S101).

SIGNAL TO NOISE RATIO (SNR) is the ratio, expressed in dB, of the rms value of the input signal to the rms value of the sum of all other spectral components below one-half the sampling frequency, not including harmonics or dc.

SIGNAL TO NOISE PLUS DISTORTION (S/N+D or SINAD) is the ratio, expressed in dB, of the rms value of the input signal to the rms value of all of the other spectral components below half the clock frequency, including harmonics but excluding dc.

SPURIOUS FREE DYNAMIC RANGE (SFDR) is the difference, expressed in dB, between the rms values of the input signal and the peak spurious signal, where a spurious signal is any signal present in the output spectrum that is not present at the input.

TOTAL HARMONIC DISTORTION (THD) is the ratio, expressed in dBc, of the rms total of the first five harmonic levels at the output to the level of the fundamental at the output. THD is calculated as

$$\text{THD} = 20 \cdot \log_{10} \sqrt{\frac{A_{f_2}^2 + \dots + A_{f_6}^2}{A_{f_1}^2}}$$

where A_{f_1} is the RMS power of the fundamental (output) frequency and A_{f_2} through A_{f_6} are the RMS power in the first 5 harmonic frequencies.

TOTAL UNADJUSTED ERROR is the worst deviation found from the ideal transfer function. As such, it is a comprehensive specification which includes full scale error, linearity error, and offset error.

Timing Diagrams

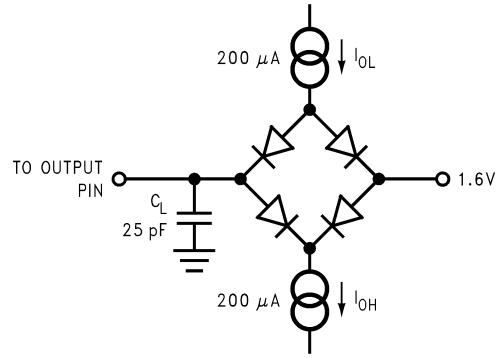

20110208

FIGURE 1. Timing Test Circuit

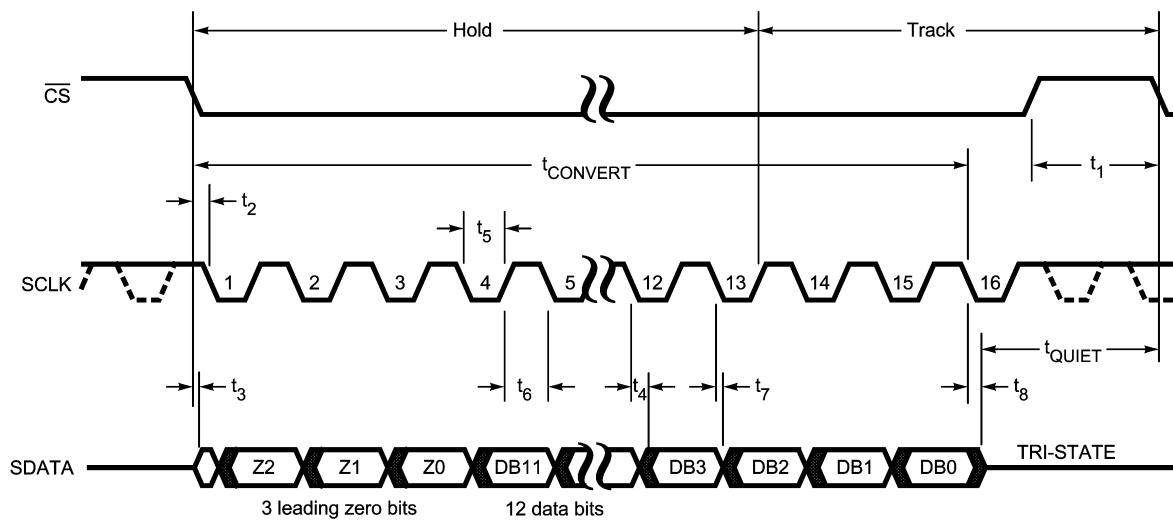

20110202

FIGURE 2. ADC121S101 Serial Interface Timing Diagram

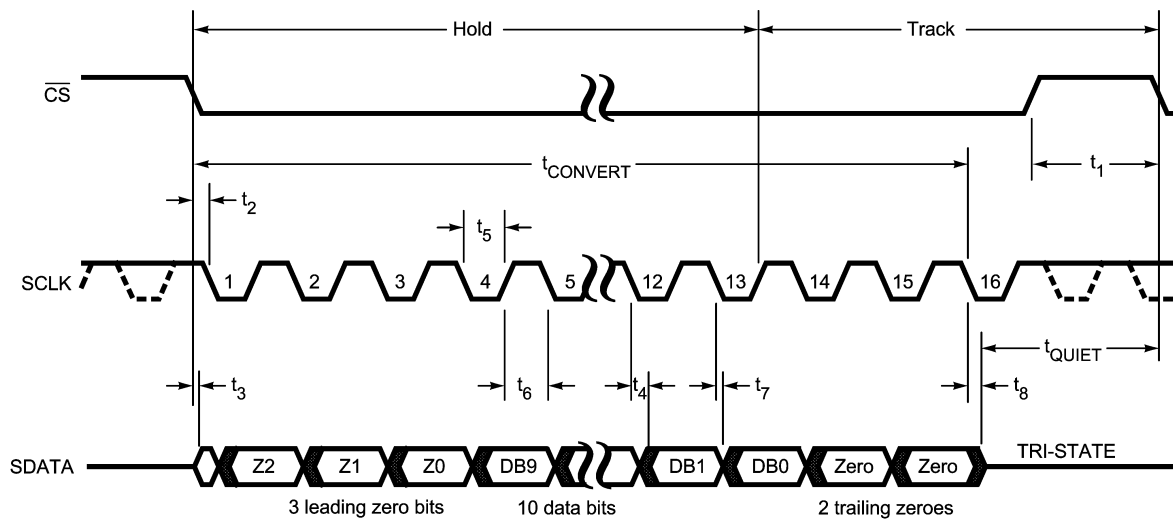

20110203

FIGURE 3. ADC101S101 Serial Interface Timing Diagram

Timing Diagrams (Continued)

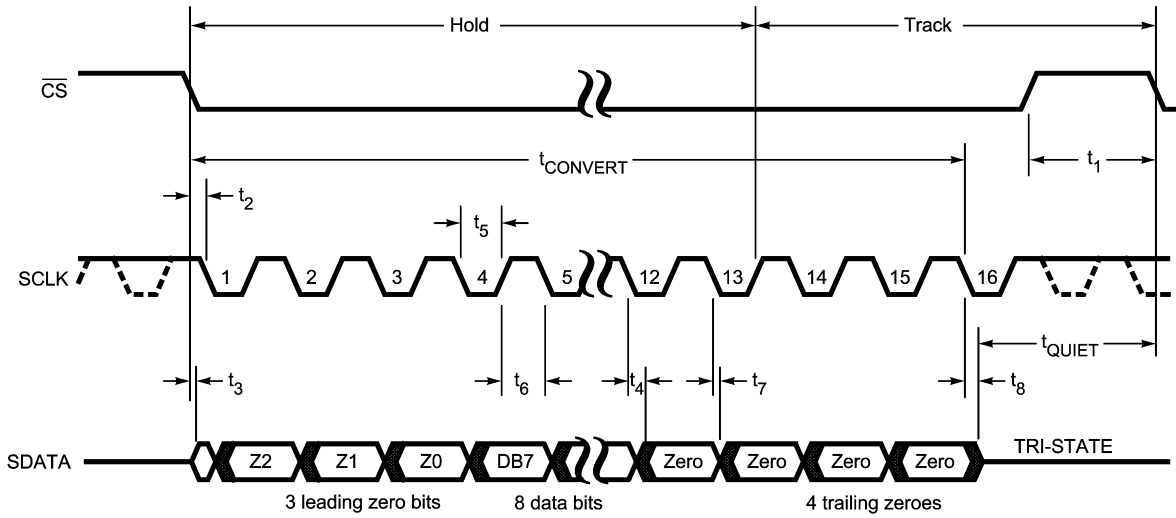

20110204

FIGURE 4. ADC081S101 Serial Interface Timing Diagram

Typical Performance Characteristics $T_A = +25^\circ\text{C}$, $V_{DD} = 3\text{V}$, $f_{\text{SAMPLE}} = 1\text{ MSPS}$, $f_{\text{SCLK}} = 20\text{ MHz}$, $f_{\text{IN}} = 100\text{ kHz}$ unless otherwise stated.

ADC121S101

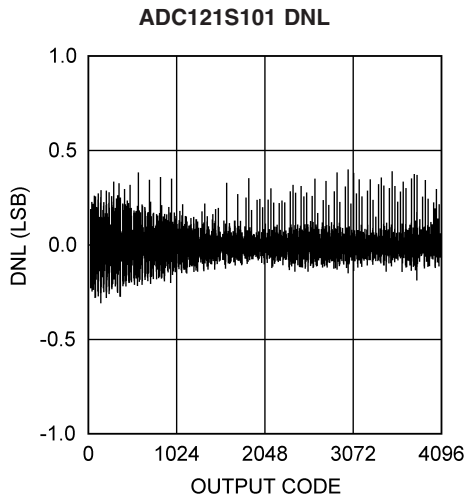

20110206

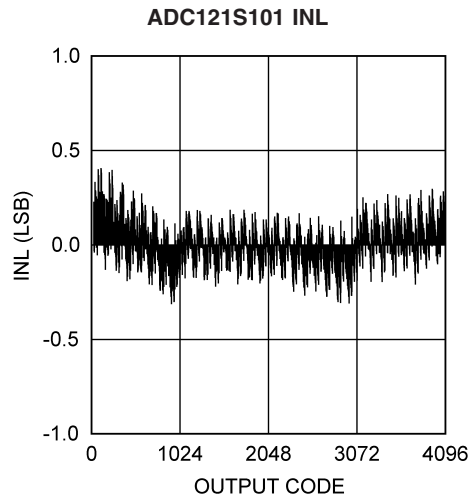

20110205

ADC121S101 Spectral Response @ 100 kHz Input

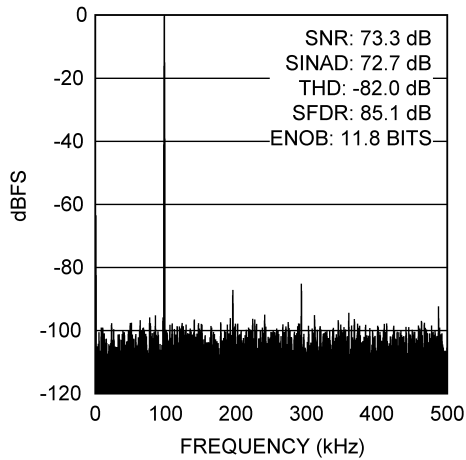

20110207

ADC121S101 THD vs. Source Impedance

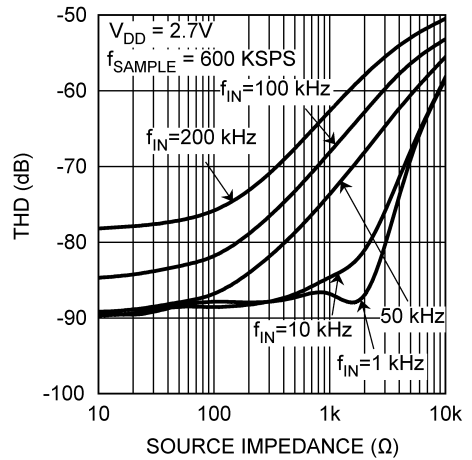

20110250

ADC121S101 THD vs. Input Frequency, 600 kSPS

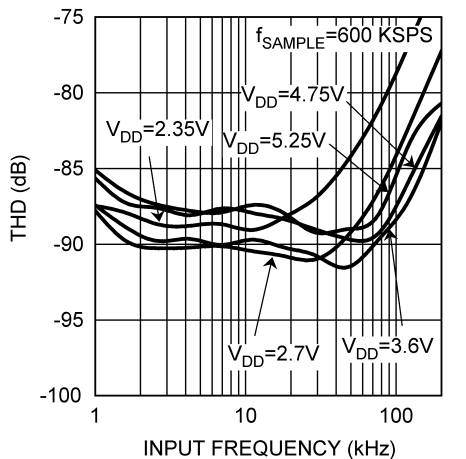

20110251

ADC121S101 THD vs. Input Frequency, 1 MSPS

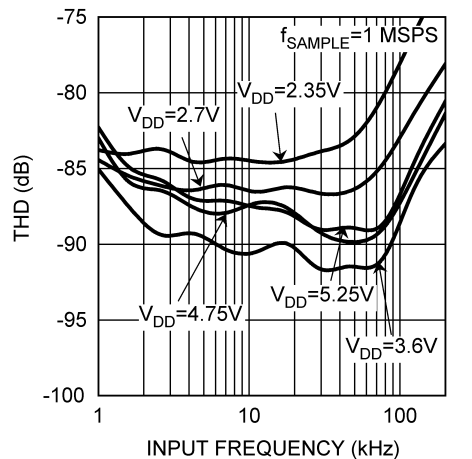

20110252

Typical Performance Characteristics $T_A = +25^\circ\text{C}$, $V_{DD} = 3\text{V}$, $f_{\text{SAMPLE}} = 1\text{ MSPS}$, $f_{\text{SCLK}} = 20\text{ MHz}$, $f_{\text{IN}} = 100\text{ kHz}$ unless otherwise stated. (Continued)

ADC121S101 SINAD vs. Input Frequency, 600 kSPS

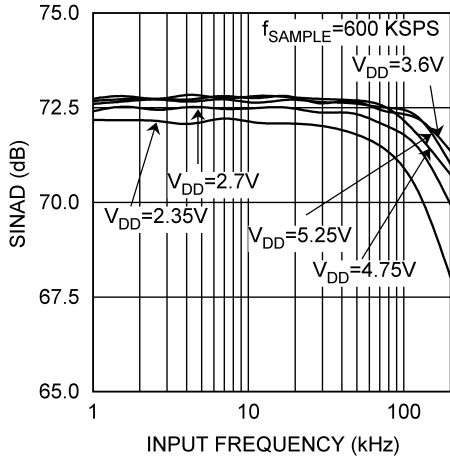

20110253

ADC121S101 SINAD vs. Input Frequency, 1 MSPS

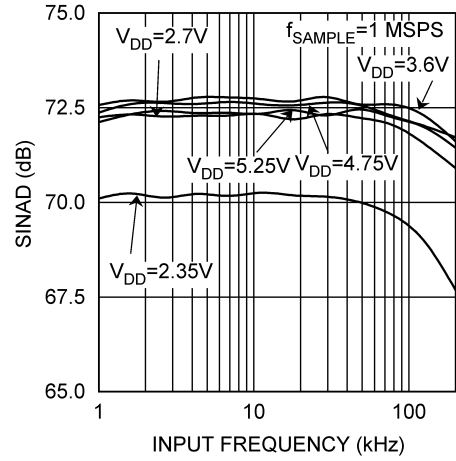

20110254

ADC121S101 SNR vs. f_{SCLK}

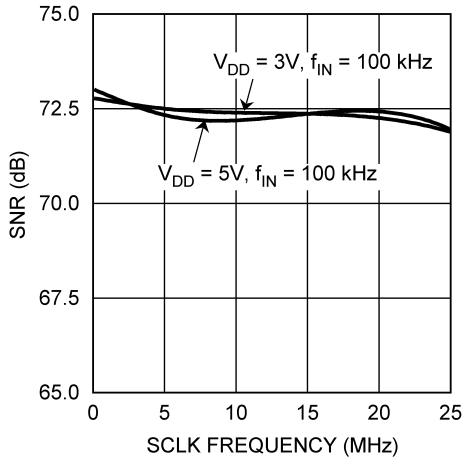

20110256

ADC121S101 SINAD vs. f_{SCLK}

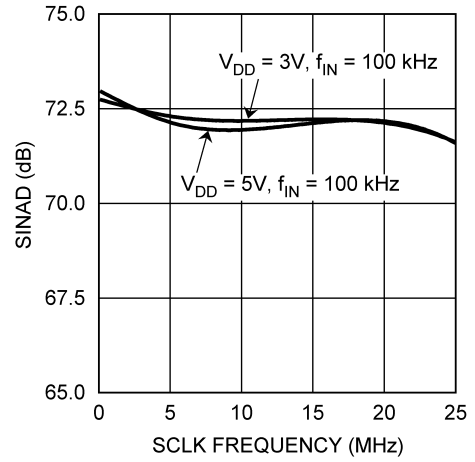

20110257

Typical Performance Characteristics $T_A = +25^\circ\text{C}$, $V_{DD} = 3\text{V}$, $f_{\text{SAMPLE}} = 1\text{ MSPS}$, $f_{\text{SCLK}} = 20\text{ MHz}$, $f_{\text{IN}} = 100\text{ kHz}$ unless otherwise stated. (Continued)

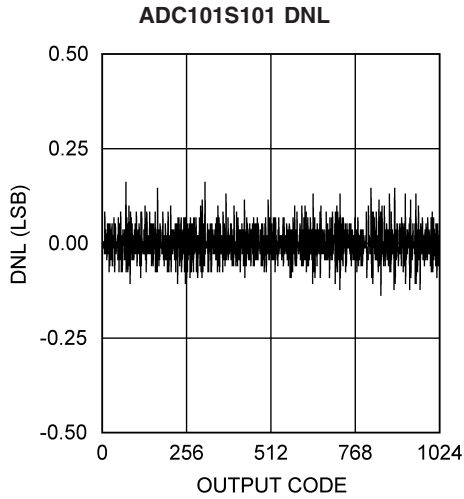

20110270

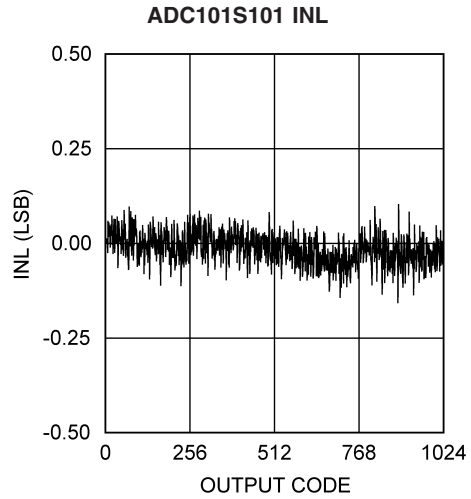

20110271

ADC101S101 Spectral Response @ 100 kHz Input

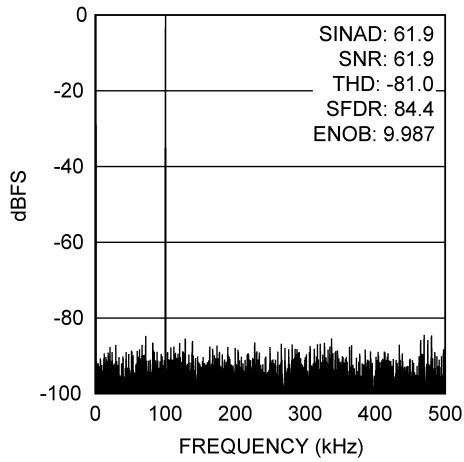

20110272

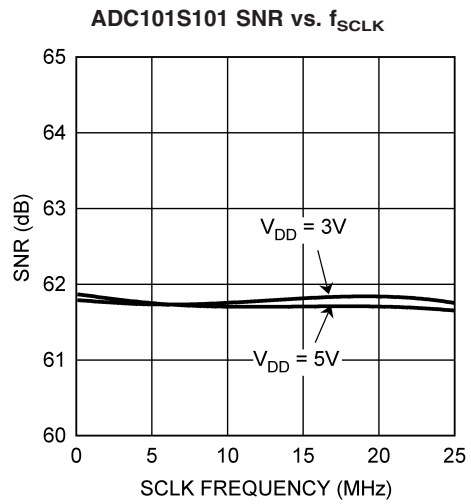

20110273

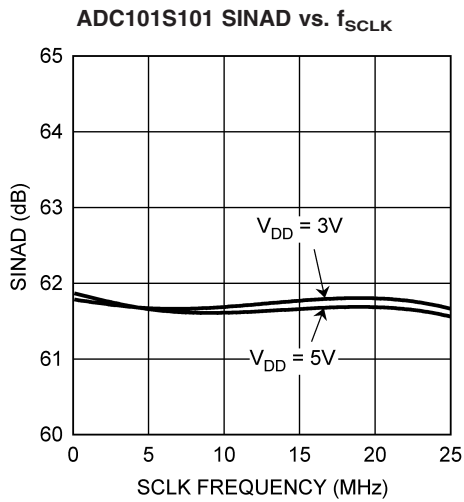

20110274

Typical Performance Characteristics $T_A = +25^\circ\text{C}$, $V_{DD} = 3\text{V}$, $f_{\text{SAMPLE}} = 1\text{ MSPS}$, $f_{\text{SCLK}} = 20\text{ MHz}$, $f_{\text{IN}} = 100\text{ kHz}$ unless otherwise stated. (Continued)

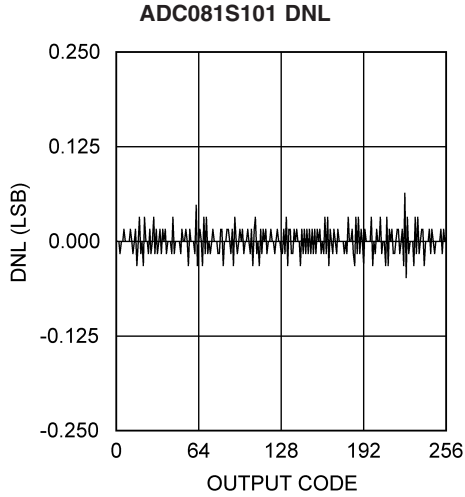

20110260

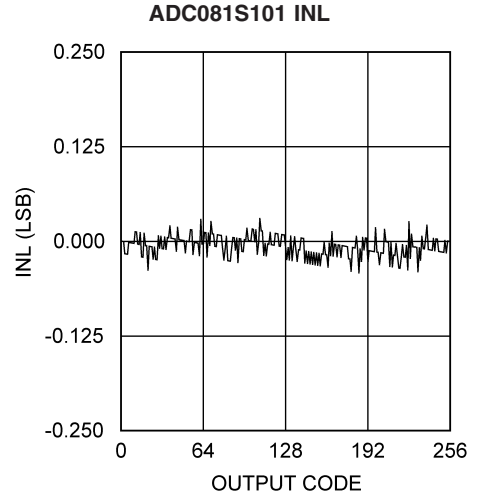

20110261

ADC081S101 Spectral Response @ 100 kHz Input

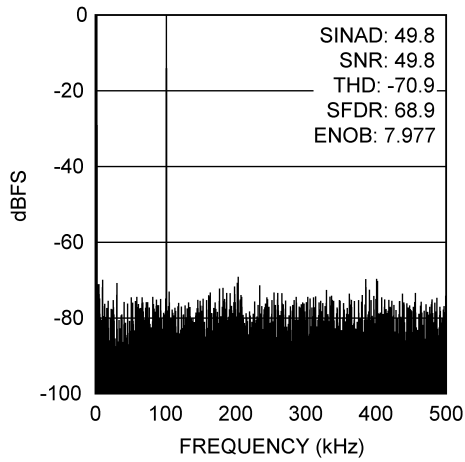

20110262

ADC081S101 SNR vs. f_{SCLK}

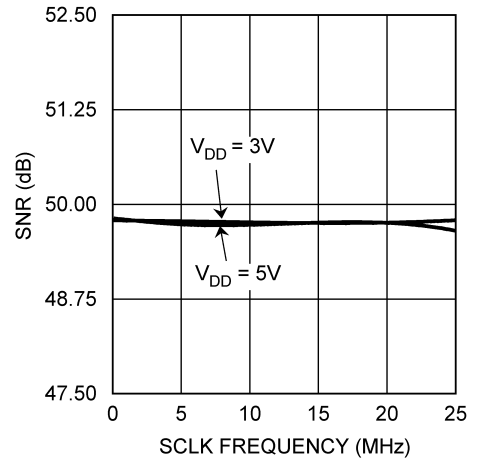

20110263

ADC081S101 SINAD vs. f_{SCLK}

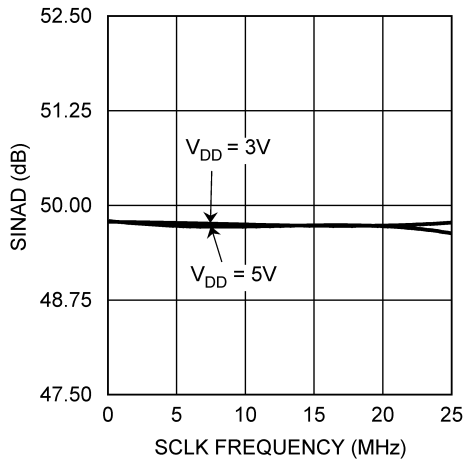

20110264

Power Consumption vs. Throughput

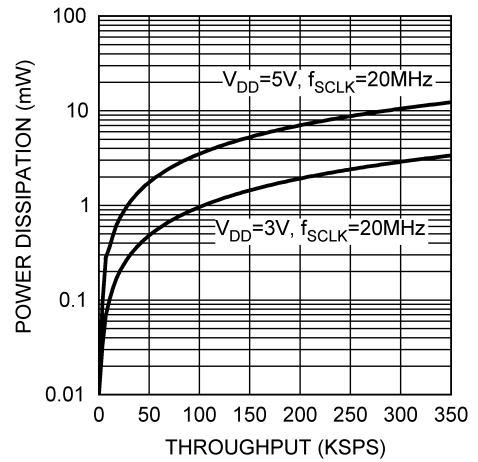

20110255

Applications Information

1.0 ADC121S101/101S101/081S101 OPERATION

The ADC121S101/101S101/081S101 are successive-approximation analog-to-digital converters designed around a charge-redistribution digital-to-analog converter. Simplified schematics of the ADC121S101/101S101/081S101 in both track and hold operation are shown in Figures 4 and 5, respectively. In Figure 4, the device is in track mode: switch SW1 connects the sampling capacitor to the input, and SW2 balances the comparator inputs. The device is in this state until \overline{CS} is brought low, at which point the device moves to hold mode.

Figure 5 shows the device in hold mode: switch SW1 connects the sampling capacitor to ground, maintaining the sampled voltage, and switch SW2 unbalances the comparator. The control logic then instructs the charge-redistribution DAC to add or subtract fixed amounts of charge from the sampling capacitor until the comparator is balanced. When the comparator is balanced, the digital word supplied to the DAC is the digital representation of the analog input voltage. The device moves from hold mode to track mode on the 13th rising edge of SCLK.

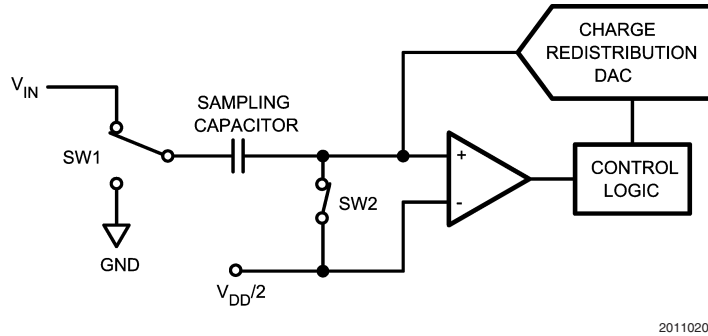

FIGURE 5. ADC121S101/101S101/081S101 in Track Mode

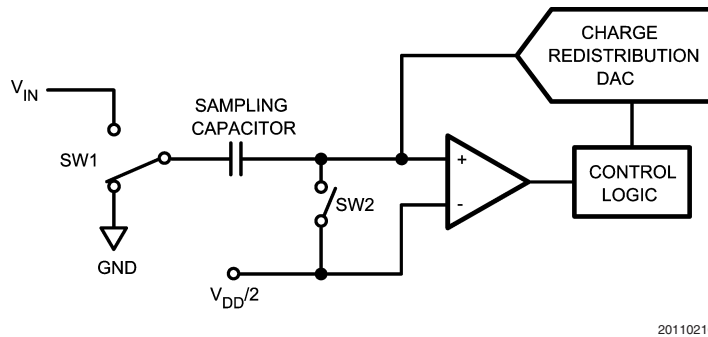

FIGURE 6. ADC121S101/101S101/081S101 in Hold Mode

2.0 USING THE ADC121S101/101S101/081S101

Serial interface timing diagrams for the ADC121S101/101S101/081S101 are shown in Figures 1, 2, and 3. \overline{CS} is chip select, which initiates conversions on the ADC121S101/101S101/081S101 and frames the serial data transfers. SCLK (serial clock) controls both the conversion process and the timing of serial data. SDATA is the serial data out pin, where a conversion result is found as a serial data stream.

Basic operation of the ADC121S101/101S101/081S101 begins with \overline{CS} going low, which initiates a conversion process and data transfer. Subsequent rising and falling edges of SCLK will be labelled with reference to the falling edge of \overline{CS} ; for example, "the third falling edge of SCLK" shall refer to the third falling edge of SCLK after \overline{CS} goes low.

At the fall of \overline{CS} , the SDATA pin comes out of TRI-STATE, and the converter moves from track mode to hold mode. The input signal is sampled and held for conversion on the falling edge of \overline{CS} . The converter moves from hold mode to track

mode on the 13th rising edge of SCLK (see Figure 1, 2, or 3). The SDATA pin will be placed back into TRI-STATE after the 16th falling edge of SCLK, or at the rising edge of \overline{CS} , whichever occurs first. After a conversion is completed, the quiet time t_{QUIET} must be satisfied before bringing \overline{CS} low again to begin another conversion.

Sixteen SCLK cycles are required to read a complete sample from the ADC121S101/101S101/081S101. The sample bits (including any leading or trailing zeroes) are clocked out on falling edges of SCLK, and are intended to be clocked in by a receiver on subsequent falling edges of SCLK. The ADC121S101/101S101/081S101 will produce three leading zero bits on SDATA, followed by twelve, ten, or eight data bits, most significant first. After the data bits, the ADC101S101 will clock out two trailing zeros, and the ADC081S101 will clock out four trailing zeros. The ADC121S101 will not clock out any trailing zeros; the least significant data bit will be valid on the 16th falling edge of SCLK.

Applications Information (Continued)

If \overline{CS} goes low before the rising edge of SCLK, an additional (fourth) zero bit may be captured by the next falling edge of SCLK.

3.0 ADC121S101/101S101/081S101 TRANSFER FUNCTION

The output format of the ADC121S101/101S101/081S101 is straight binary. Code transitions occur midway between suc-

cessive integer LSB values. The LSB widths for the ADC121S101 is $V_{DD} / 4096$; for the ADC101S101 the LSB width is $V_{DD} / 1024$; for the ADC081S101, the LSB width is $V_{DD} / 256$. The ideal transfer characteristic for the ADC121S101 and ADC101S101 is shown in Figure 6, while the ideal transfer characteristic for the ADC081S101 is shown in Figure 7.

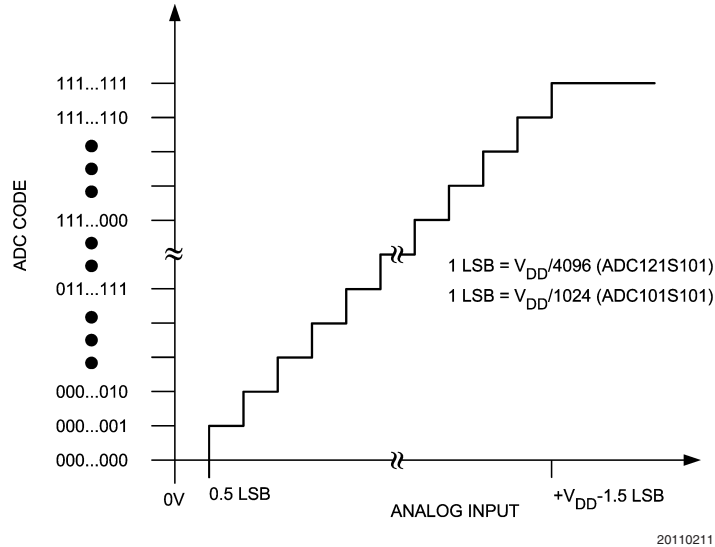

FIGURE 7. ADC121S101/101S101 Ideal Transfer Characteristic

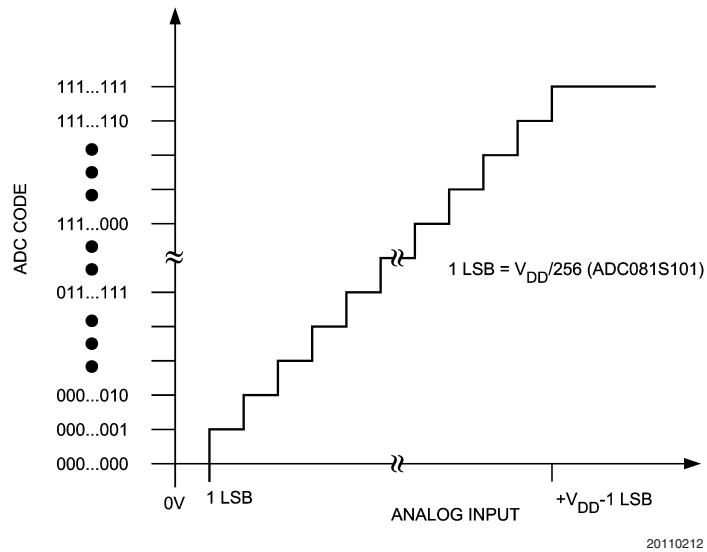

FIGURE 8. ADC081S101 Ideal Transfer Characteristic

Applications Information (Continued)

4.0 SAMPLE CIRCUIT

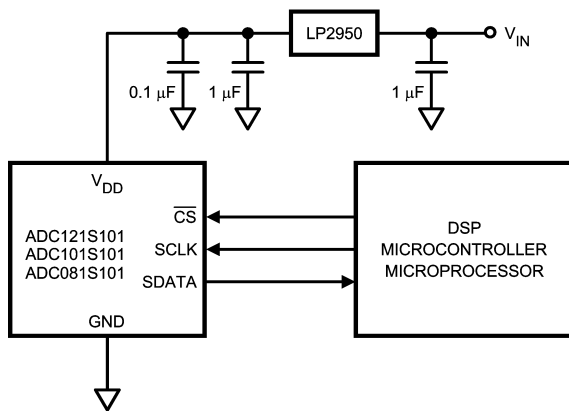

FIGURE 9. Sample Circuit

A typical application of the ADC121S101/101S101/081S101 is shown in Figure 8. The combined analog and digital supplies are provided in this example by the National LP2950 low-dropout voltage regulator, available in a variety of fixed and adjustable output voltages. The supply is bypassed with a capacitor network located close to the device. The three-wire interface is also shown connected to a microprocessor or DSP.

5.0 ANALOG INPUTS

An equivalent circuit for the ADC121S101/101S101/081S101 input channel is shown in Figure 9. The diodes D1 and D2 provide ESD protection for the analog inputs. At no time should an analog input exceed $V_{DD} + 300\text{ mV}$ or $GND - 300\text{ mV}$, as these ESD diodes will begin conducting current into the substrate and affect ADC operation.

The capacitor C1 in Figure 9 typically has a value of 4 pF, and is mainly due to pin capacitance. The resistor R1 represents the on resistance of the multiplexer and track / hold switch, and is typically 100 ohms. The capacitor C2 is the ADC121S101/101S101/081S101 sampling capacitor, and is typically 26 pF.

The sampling nature of the analog input causes input current pulses that result in voltage spikes at the input. The ADC121S101/101S101/081S101 will deliver best performance when driven by a low-impedance source to eliminate distortion caused by the charging of the sampling capacitance. In applications where dynamic performance is critical, the input might need to be driven with a low output-impedance amplifier. In addition, when using the ADC121S101/101S101/081S101 to sample AC signals, a band-pass or low-pass filter will reduce harmonics and noise and thus improve THD and SNR.

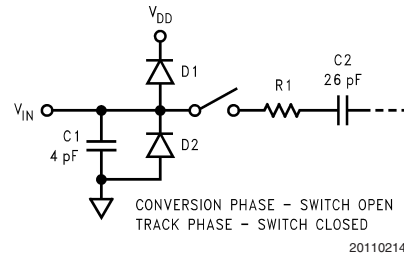

FIGURE 10. Equivalent Input Circuit

6.0 DIGITAL INPUTS AND OUTPUTS

The ADC121S101/101S101/081S101 digital inputs (SCLK and \overline{CS}) are not limited by the same absolute maximum ratings as the analog inputs. The digital input pins are instead limited to +6.5V with respect to GND, regardless of V_{DD} , the supply voltage. This allows the ADC121S101/101S101/081S101 to be interfaced with a wide range of logic levels, independent of the supply voltage.

Note that, even though the digital inputs are tolerant of up to +6.5V above GND, the digital outputs are only capable of driving V_{DD} out. In addition, the digital input pins are not prone to latch-up; SCLK and \overline{CS} may be asserted before V_{DD} without any risk.

7.0 MODES OF OPERATION

The ADC121S101/101S101/081S101 has two possible modes of operation: normal mode, and shutdown mode. The ADC121S101/101S101/081S101 enters normal mode (and a conversion process is begun) when \overline{CS} is pulled low. The device will enter shutdown mode if \overline{CS} is pulled high before the tenth falling edge of SCLK after \overline{CS} is pulled low, or will stay in normal mode if \overline{CS} remains low. Once in shutdown mode, the device will stay there until \overline{CS} is brought low again. By varying the ratio of time spent in the normal and shutdown modes, a system may trade-off throughput for power consumption.

8.0 NORMAL MODE

The best possible throughput is obtained by leaving the ADC121S101/101S101/081S101 in normal mode at all times, so there are no power-up delays. To keep the device in normal mode continuously, \overline{CS} must be kept low until after the 10th falling edge of SCLK after the start of a conversion (remember that a conversion is initiated by bringing \overline{CS} low). If \overline{CS} is brought high after the 10th falling edge, but before the 16th falling edge, the device will remain in normal mode, but the current conversion will be aborted, and SDATA will return to TRI-STATE (truncating the output word).

Sixteen SCLK cycles are required to read all of a conversion word from the device. After sixteen SCLK cycles have elapsed, \overline{CS} may be idled either high or low until the next conversion. If \overline{CS} is idled low, it must be brought high again before the start of the next conversion, which begins when \overline{CS} is again brought low.

After sixteen SCLK cycles, SDATA returns to TRI-STATE. Another conversion may be started, after t_{QUIET} has elapsed, by bringing \overline{CS} low again.

Applications Information (Continued)

9.0 SHUTDOWN MODE

Shutdown mode is appropriate for applications that either do not sample continuously, or are willing to trade throughput for power consumption. When the ADC121S101/101S101/081S101 is in shutdown mode, all of the analog circuitry is turned off.

To enter shutdown mode, a conversion must be interrupted by bringing \overline{CS} back high anytime between the second and

tenth falling edges of SCLK, as shown in Figure 10. Once \overline{CS} has been brought high in this manner, the device will enter shutdown mode; the current conversion will be aborted and SDATA will enter TRI-STATE. If \overline{CS} is brought high before the second falling edge of SCLK, the device will not change mode; this is to avoid accidentally changing mode as a result of noise on the \overline{CS} line.

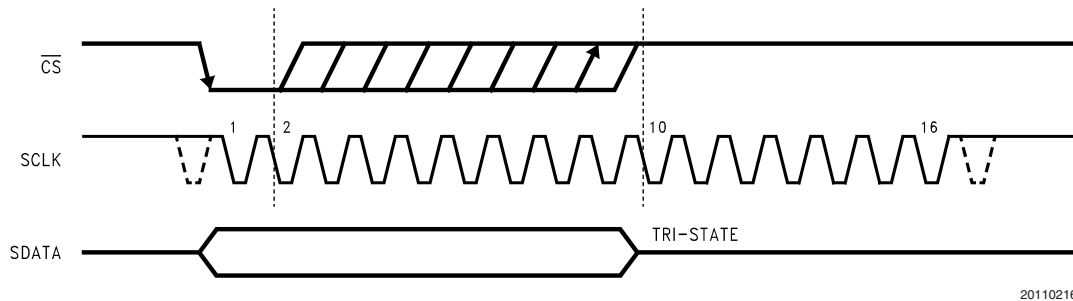

FIGURE 11. Entering Shutdown Mode

10.0 EXITING SHUTDOWN MODE

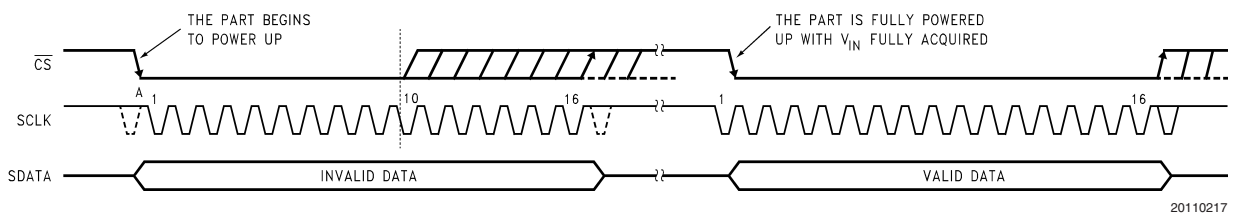

FIGURE 12. Entering Normal Mode

To exit shutdown mode, bring \overline{CS} back low. Upon bringing \overline{CS} low, the ADC121S101/101S101/081S101 will begin powering up. Power up typically takes 1 μ s. This microsecond of power-up delay results in the first conversion result being unusable. The second conversion performed after power-up, however, is valid, as shown in Figure 11.

If \overline{CS} is brought back high before the 10th falling edge of SCLK, the device will return to shutdown mode. This is done to avoid accidentally entering normal mode as a result of noise on the \overline{CS} line. To exit shutdown mode and remain in normal mode, \overline{CS} must be kept low until after the 10th falling edge of SCLK. The ADC121S101/101S101/081S101 will be fully powered-up after 16 SCLK cycles.

11.0 POWER-UP TIMING

The ADC121S101/101S101/081S101 typically requires 1 μ s to power up, either after first applying V_{DD} , or after returning to normal mode from shutdown mode. This corresponds to one "dummy" conversion for any SCLK frequency within the specifications in this document. After this first dummy conversion, the ADC121S101/101S101/081S101 will perform conversions properly. Note that the t_{QUIET} time must still be included between the first dummy conversion and the second valid conversion.

12.0 STARTUP MODE

When the V_{DD} supply is first applied, the ADC121S101/101S101/081S101 may power up in either of the two modes: normal or shutdown. As such, one dummy conversion should be performed after start-up, exactly as described in Section 11.0. The part may then be placed into either normal mode or the shutdown mode, as described in Sections 8.0 and 9.0.

13.0 POWER MANAGEMENT

When the ADC121S101/101S101/081S101 is operated continuously in normal mode, throughput up to 1 MSPS can be achieved. The user may trade throughput for power consumption by simply performing fewer conversions per unit time, and putting the ADC121S101/101S101/081S101 into shutdown mode between conversions. This method is not advantageous beyond 350 kSPS throughput.

A plot of maximum power consumption versus throughput is shown in Figure 12 below. To calculate the power consumption for a given throughput, remember that each time the part exits shutdown mode and enters normal mode, one dummy conversion is required. Generally, the user will put the part into normal mode, execute one dummy conversion followed by one valid conversion, and then put the part back into shutdown mode. When this is done, the fraction of time

Applications Information (Continued)

spent in normal mode may be calculated by multiplying the throughput (in samples per second) by $2 \mu\text{s}$, the time taken to perform one dummy and one valid conversion. The power consumption can then be found by multiplying the fraction of time spent in normal mode by the normal mode power consumption figure. The power dissipated while the part is in shutdown mode is negligible.

For example, to calculate the power consumption at 300 kSPS with $V_{DD} = 5\text{V}$, begin by calculating the fraction of time spent in normal mode: $300,000 \text{ samples/second} \cdot 2 \mu\text{s} = 0.6$, or 60%. The power consumption at 300 kSPS is then 60% of 17.5 mW (the maximum power consumption at $V_{DD} = 5\text{V}$) or 10.5 mW.

Physical Dimensions inches (millimeters) unless otherwise noted

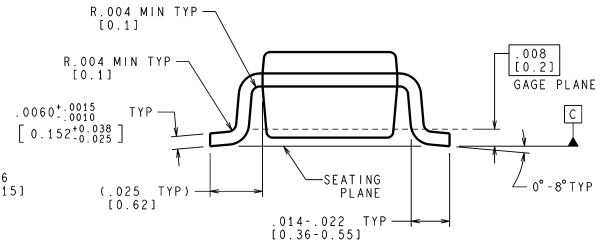
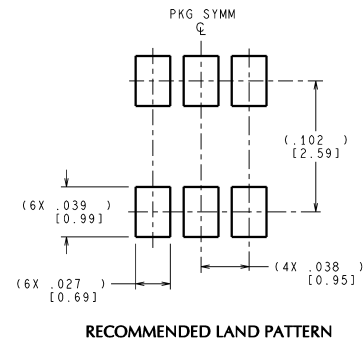
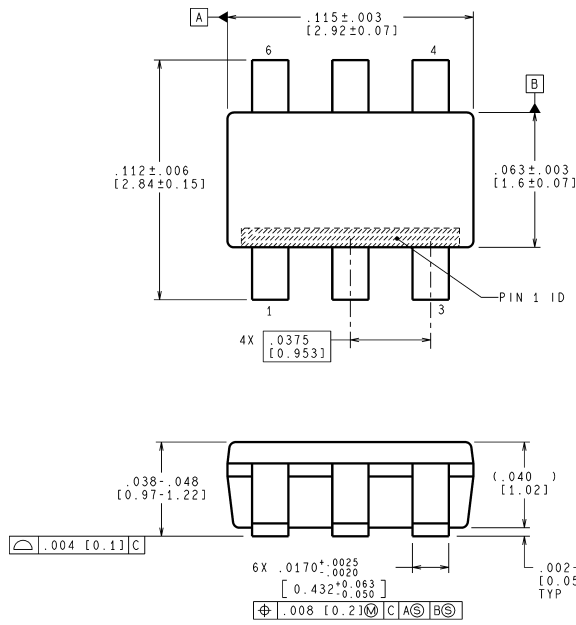

CONTROLLING DIMENSION IS INCH
VALUES IN [] ARE MILLIMETERS

MF06A (Rev B)

6-Lead SOT-23
Order Number ADC121S101CIMF, ADC121S101CIMFX, ADC101S101CIMF, ADC101S101CIMFX, ADC081S101CIMF or ADC081S101CIMFX
NS Package Number MF06A

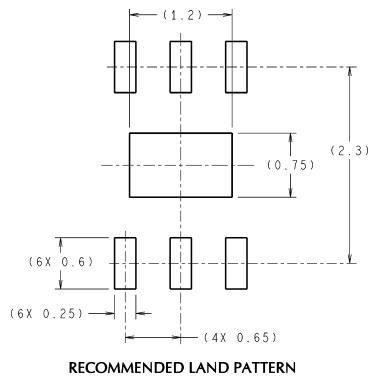

DIMENSIONS ARE IN MILLIMETERS
DIMENSIONS IN () FOR REFERENCE ONLY

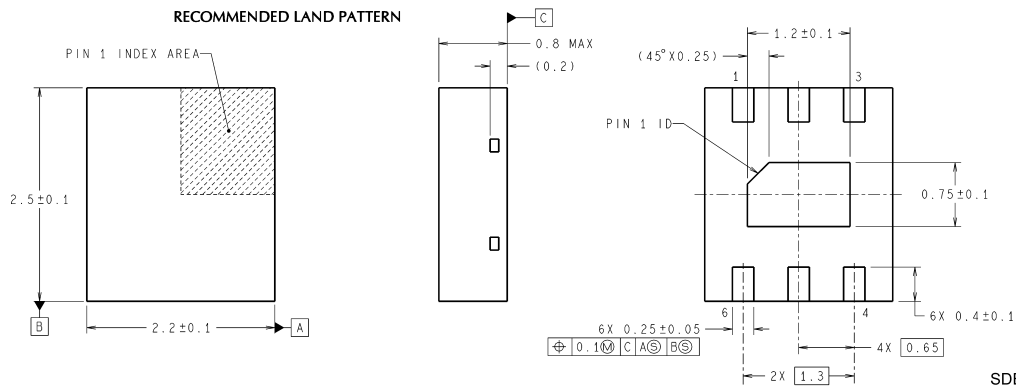

SDB06A (Rev A)

6-Lead LLP
Order Number ADC081S101CISD or ADC081S101CISDX
NS Package Number SDB06A

Notes

National does not assume any responsibility for use of any circuitry described, no circuit patent licenses are implied and National reserves the right at any time without notice to change said circuitry and specifications.

For the most current product information visit us at www.national.com.

LIFE SUPPORT POLICY

NATIONAL'S PRODUCTS ARE NOT AUTHORIZED FOR USE AS CRITICAL COMPONENTS IN LIFE SUPPORT DEVICES OR SYSTEMS WITHOUT THE EXPRESS WRITTEN APPROVAL OF THE PRESIDENT AND GENERAL COUNSEL OF NATIONAL SEMICONDUCTOR CORPORATION. As used herein:

1. Life support devices or systems are devices or systems which, (a) are intended for surgical implant into the body, or (b) support or sustain life, and whose failure to perform when properly used in accordance with instructions for use provided in the labeling, can be reasonably expected to result in a significant injury to the user.
2. A critical component is any component of a life support device or system whose failure to perform can be reasonably expected to cause the failure of the life support device or system, or to affect its safety or effectiveness.

BANNED SUBSTANCE COMPLIANCE

National Semiconductor certifies that the products and packing materials meet the provisions of the Customer Products Stewardship Specification (CSP-9-111C2) and the Banned Substances and Materials of Interest Specification (CSP-9-111S2) and contain no "Banned Substances" as defined in CSP-9-111S2.



National Semiconductor
Americas Customer
Support Center
 Email: new.feedback@nsc.com
 Tel: 1-800-272-9959

National Semiconductor
Europe Customer Support Center
 Fax: +49 (0) 180-530 85 86
 Email: europe.support@nsc.com
 Deutsch Tel: +49 (0) 69 9508 6208
 English Tel: +44 (0) 870 24 0 2171
 Français Tel: +33 (0) 1 41 91 8790

National Semiconductor
Asia Pacific Customer
Support Center
 Email: ap.support@nsc.com

National Semiconductor
Japan Customer Support Center
 Fax: 81-3-5639-7507
 Email: jpn.feedback@nsc.com
 Tel: 81-3-5639-7560