

SBD Type :11DQ06

FEATURES

- * Miniature Size
- * Low Forward Voltage drop
- * Low Power Loss, High Efficiency
- * High Surge Capability
- * 30 Volts thru 100 Volts Types Available
- * 52mm Inside Tape Spacing Package Available

OUTLINE DRAWING

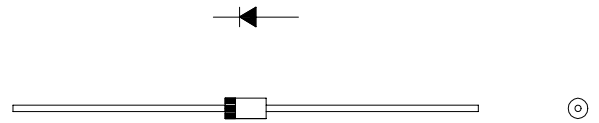

Maximum Ratings

Approx Net Weight:0.32g

Rating	Symbol	11DQ06			Unit
Repetitive Peak Reverse Voltage	V_{RRM}	60			V
Non-repetitive Peak Reverse Voltage	V_{RSM}	65			V
Average Rectified Output Current	I_O	0.89	$T_a=25^{\circ}C^*$	50Hz Half Sine Wave Resistive Load	A
		1.0	$T_a=54^{\circ}C^*$		
RMS Forward Current	$I_{F(RMS)}$	1.57			A
Surge Forward Current	I_{FSM}	25	50Hz Half Sine Wave,1cycle, Non-repetitive		A
Operating Junction Temperature Range	T_{jw}	- 40 to + 150			$^{\circ}C$
Storage Temperature Range	T_{stg}	- 40 to + 150			$^{\circ}C$

Electrical • Thermal Characteristics

Characteristics	Symbol	Conditions	Min.	Typ.	Max.	Unit
Peak Reverse Current	I_{RM}	$T_j= 25^{\circ}C, V_{RM}= V_{RRM}$	-	-	1	mA
Peak Forward Voltage	V_{FM}	$T_j= 25^{\circ}C, I_{FM}= 1.0A$	-	-	0.55	V
Thermal Resistance (Junction to Ambient)	$R_{th(j-a)}$	Without Fin or P.C.Board	-	-	130	$^{\circ}C/W$
		P.C.Board mounted	-	-	81	

*:Print Lands=5x5mm,Both Sides

11DQ06 OUTLINE DRAWING (Dimensions in mm)

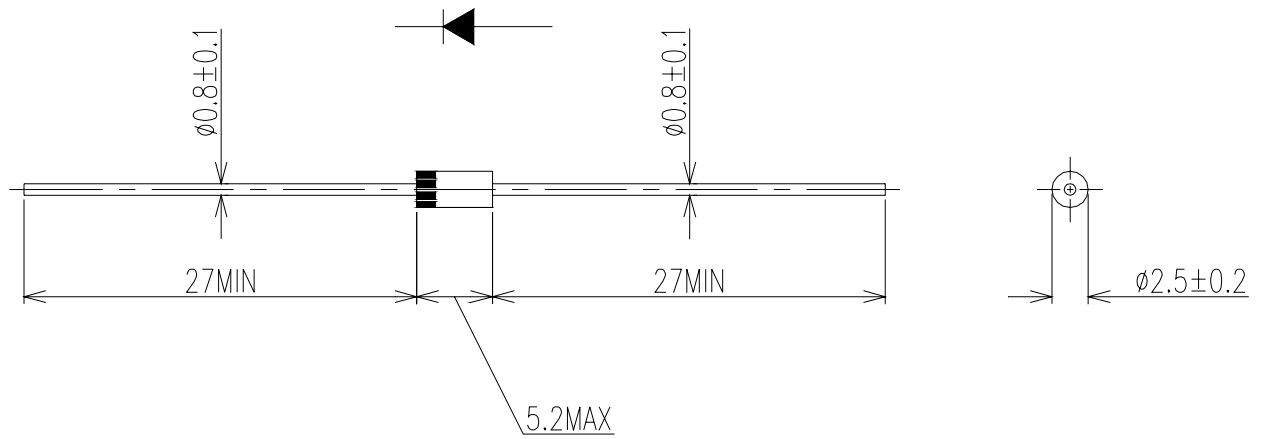

FORWARD CURRENT VS. VOLTAGE

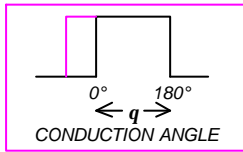
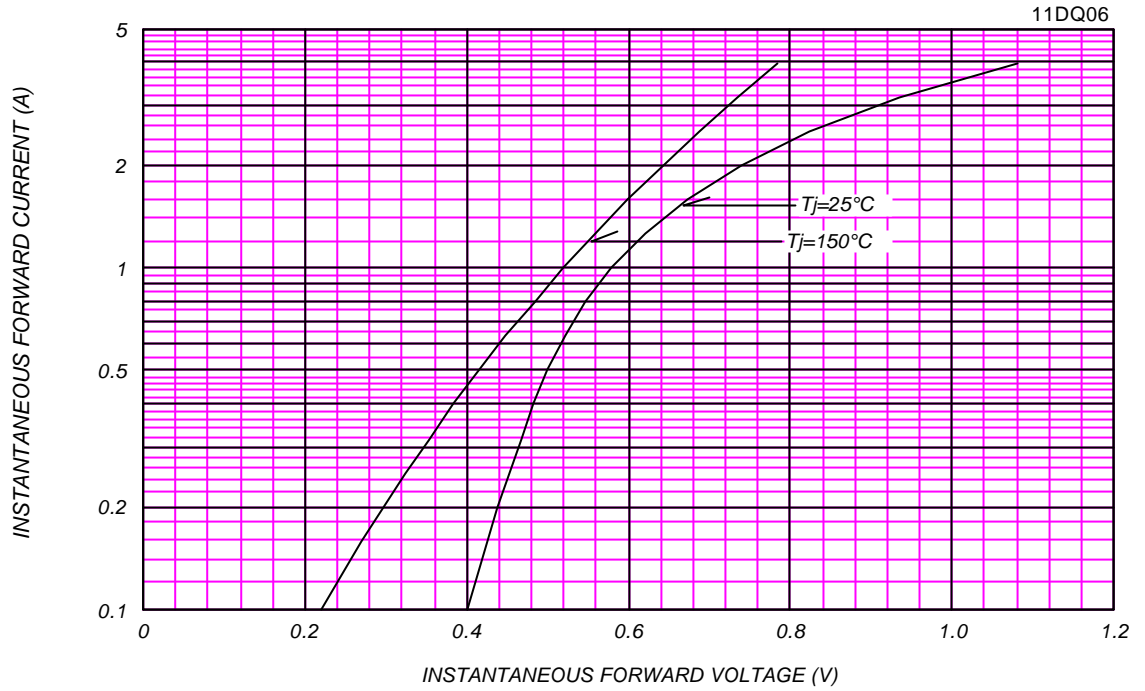

AVERAGE FORWARD POWER DISSIPATION

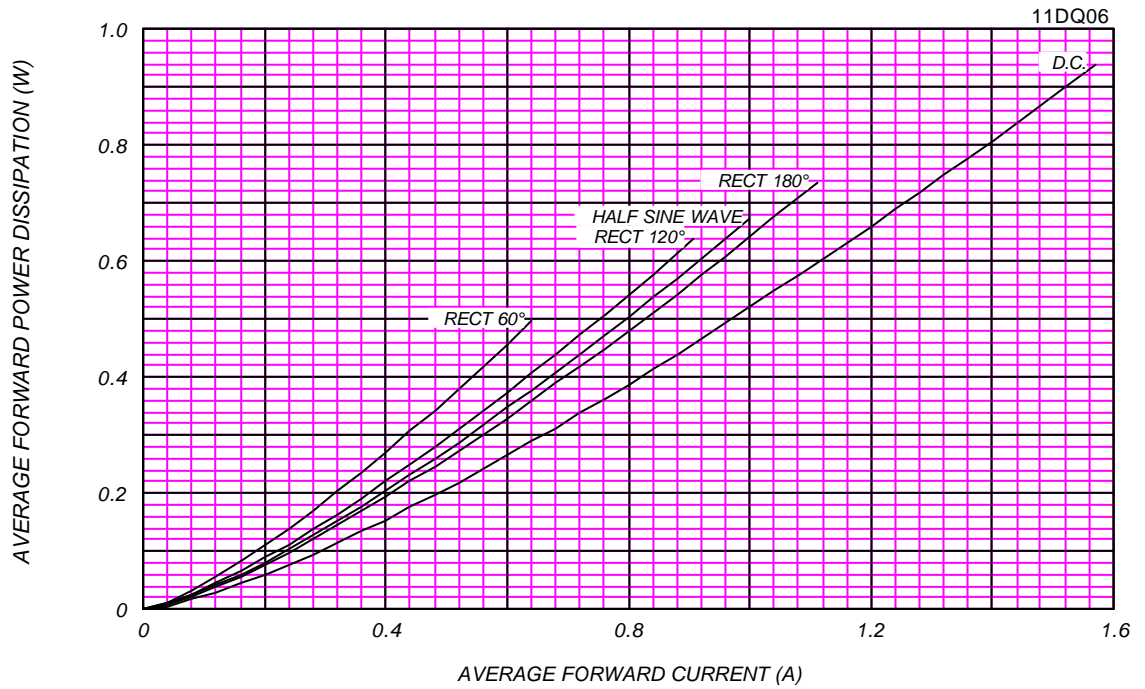

PEAK REVERSE CURRENT VS. PEAK REVERSE VOLTAGE

T_j = 150 °C

11DQ06

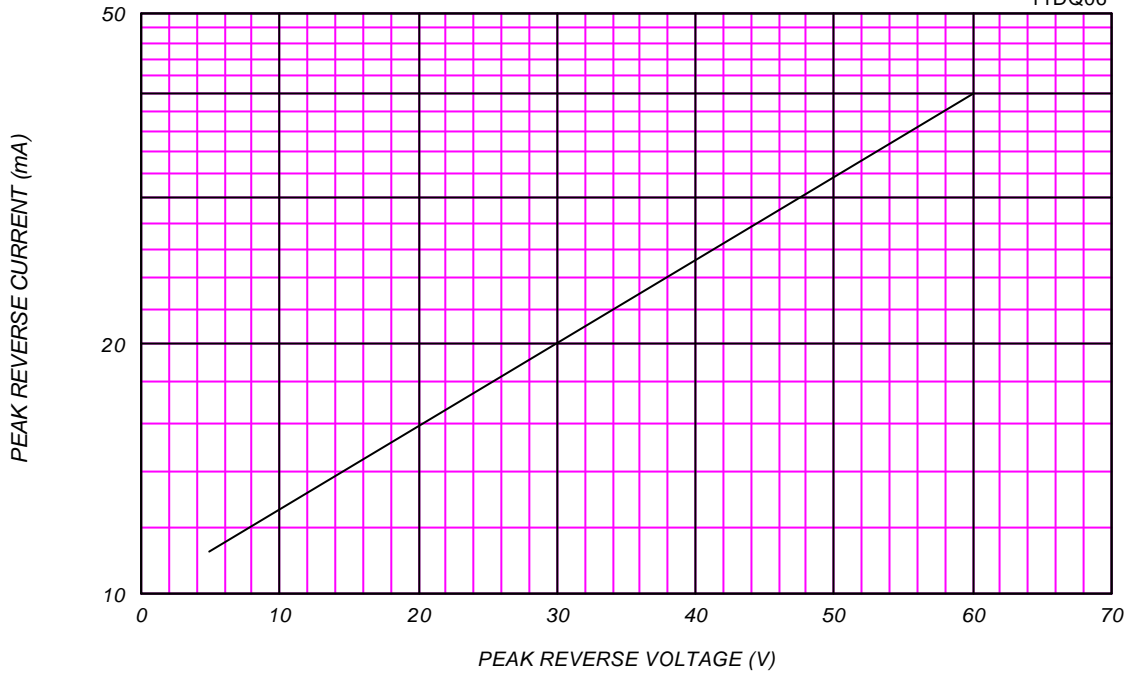

AVERAGE REVERSE POWER DISSIPATION

11DQ06

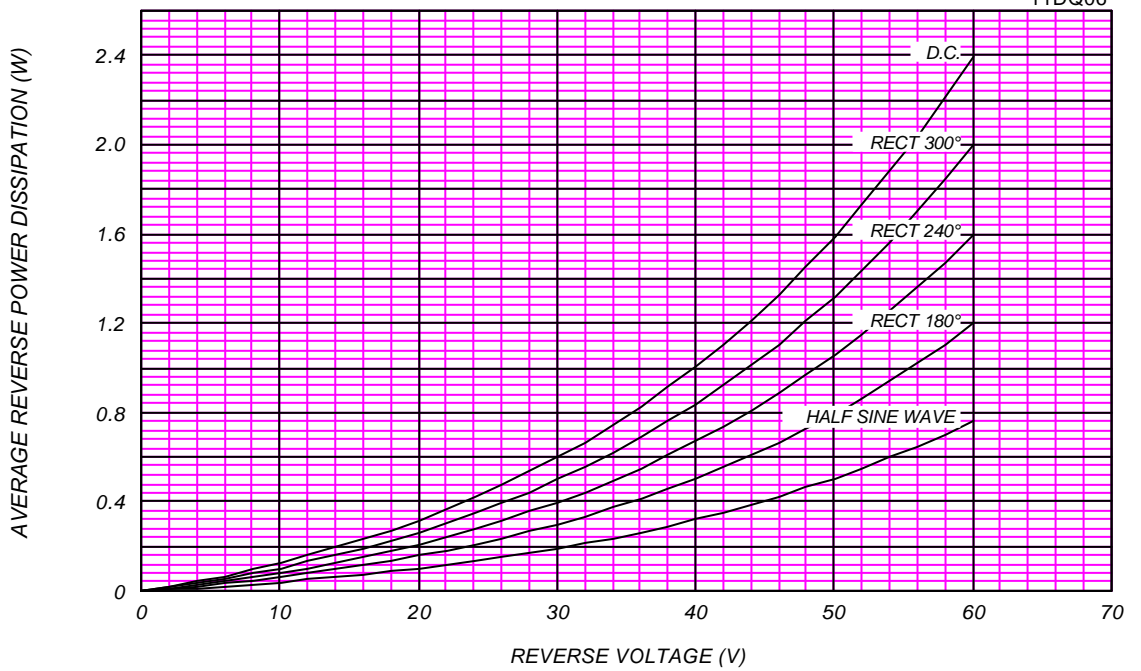

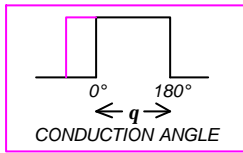

AVERAGE FORWARD CURRENT VS. AMBIENT TEMPERATURE

Without Fin or P.C. Board, $V_{RM}=60V$

11DQ06

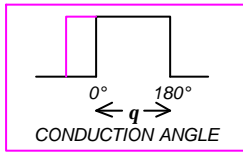
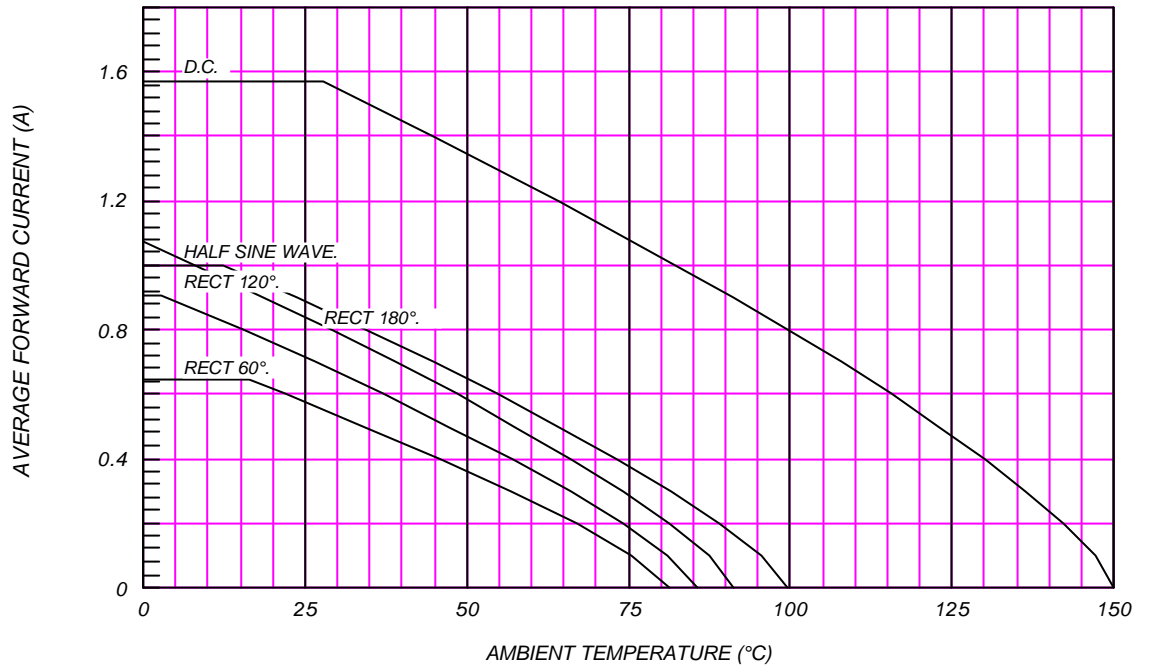

AVERAGE FORWARD CURRENT VS. AMBIENT TEMPERATURE

P.C. Board mounted (L=8mm, Print Land=10×10mm), $V_{RM}=60V$

11DQ06

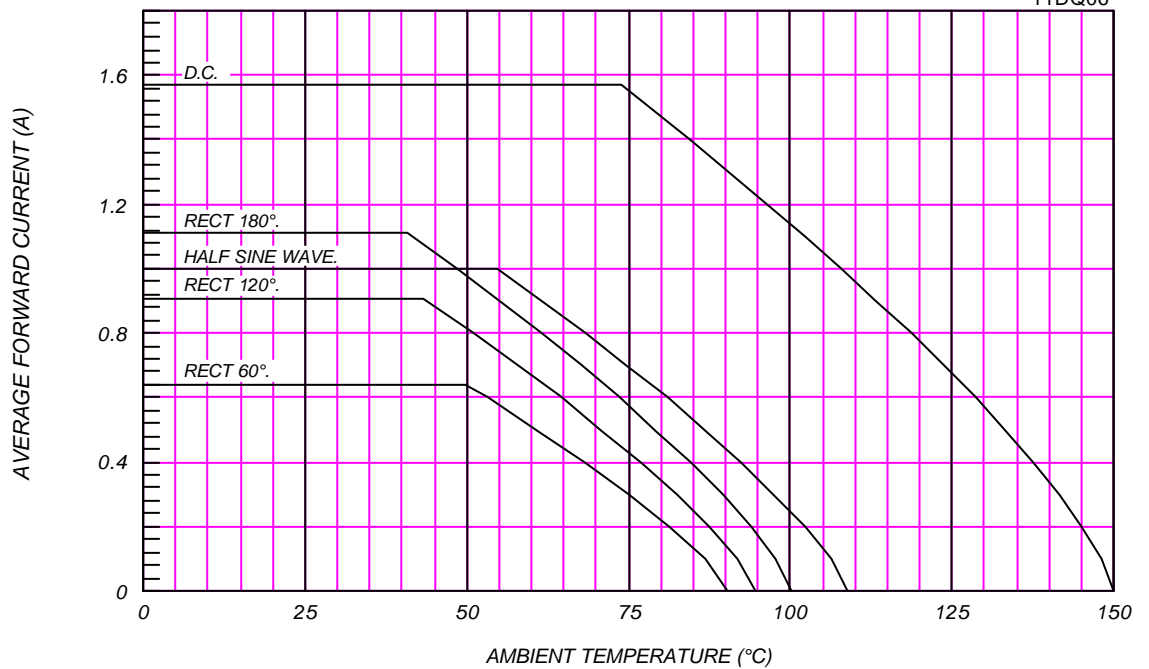

SURGE CURRENT RATINGS

f=50Hz, Half Sine Wave, Non-Repetitive, No Load

11DQ06

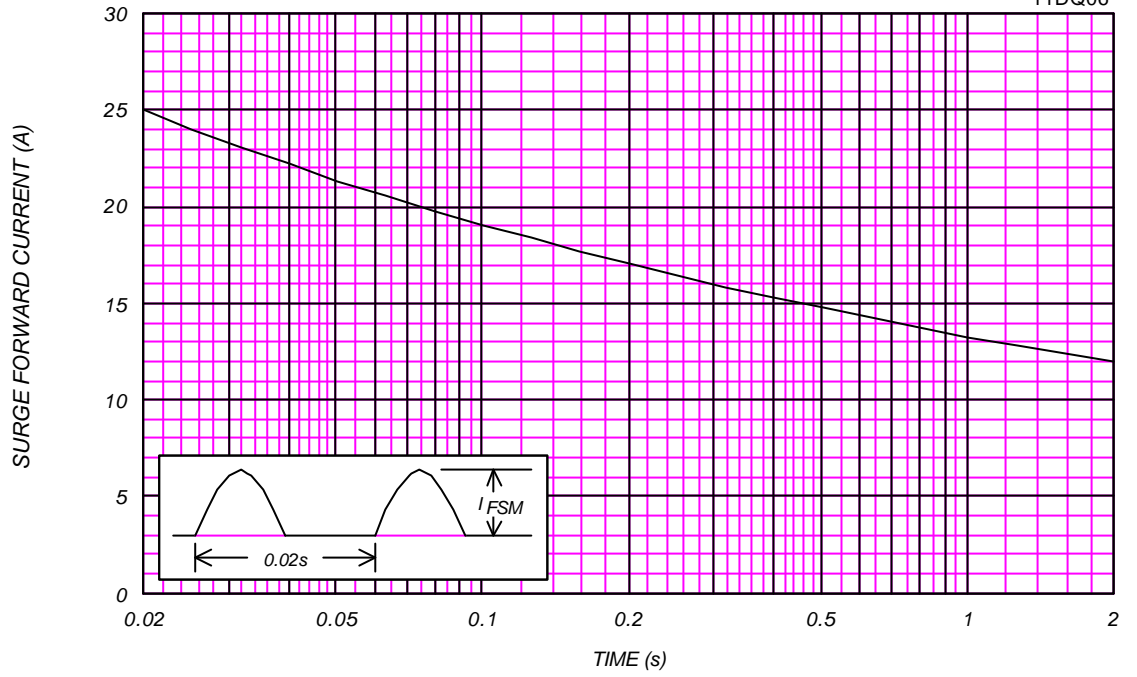

JUNCTION CAPACITANCE VS. REVERSE VOLTAGE

$T_j = 25^\circ\text{C}$, $V_m = 20\text{mV}_{\text{RMS}}$, $f = 100\text{kHz}$, Typical Value

11DQ06

