

TDA1085C

Universal Motor Speed Controller

The TDA1085C is a phase angle triac controller having all the necessary functions for universal motor speed control in washing machines. It operates in closed loop configuration and provides two ramp possibilities.

- On-Chip Frequency to Voltage Converter
- On-Chip Ramps Generator
- Soft-Start
- Load Current Limitation
- Tachogenerator Circuit Sensing
- Direct Supply from AC Line
- Security Functions Performed by Monitor

UNIVERSAL MOTOR SPEED CONTROLLER

SEMICONDUCTOR TECHNICAL DATA

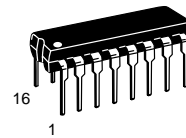

PLASTIC PACKAGE
CASE 648

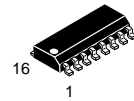

D SUFFIX
PLASTIC PACKAGE
CASE 751B
(SO-16)

ORDERING INFORMATION

Device	Operating Temperature Range	Package
TDA1085CD	$T_J = -10^\circ \text{ to } +120^\circ \text{C}$	SO-16
TDA1085C		Plastic DIP

Figure 1. Representative Block Diagram and Pin Connections

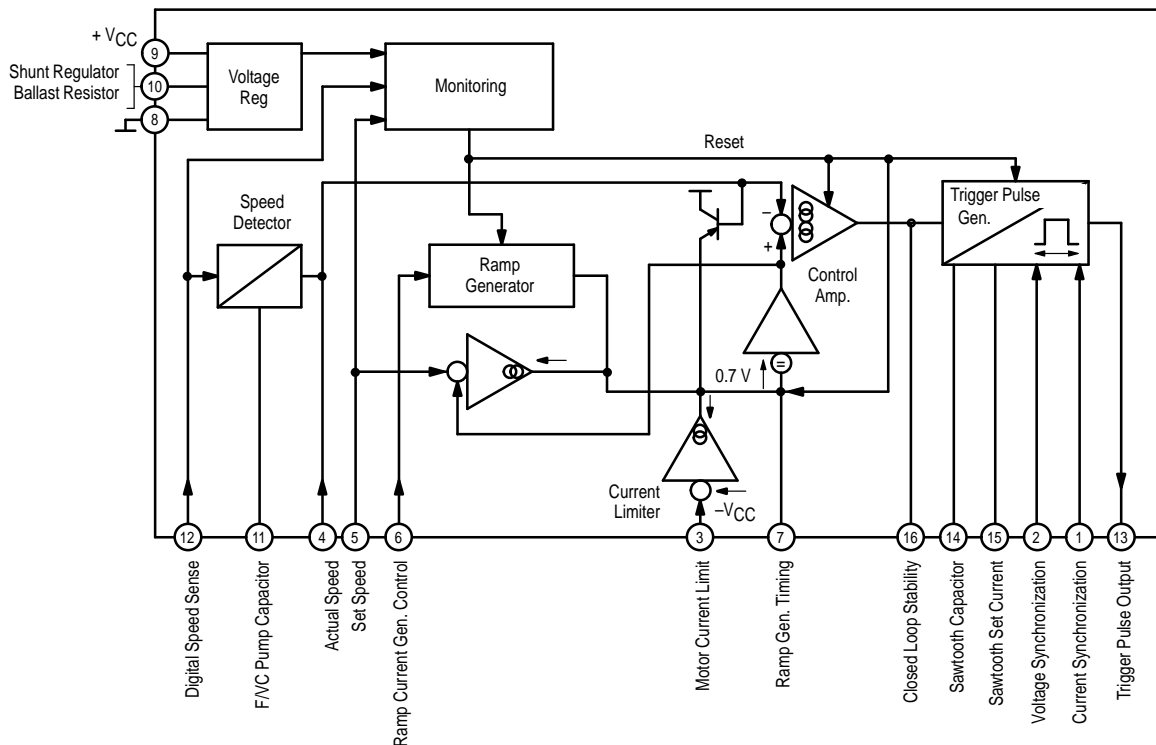

TDA1085C

MAXIMUM RATINGS ($T_A = 25^\circ\text{C}$, voltages are referenced to Pin 8, ground)

Rating	Symbol	Value	Unit
Power Supply, when externally regulated, $V_{\text{Pin 9}}$	V_{CC}	15	V
Maximum Voltage per listed pin Pin 3 Pin 4–5–6–7–13–14–16 Pin 10	V_{Pin}	+ 5.0 0 to + V_{CC} 0 to + 17	V
Maximum Current per listed pin Pin 1 and 2 Pin 3 Pin 9 (V_{CC}) Pin 10 shunt regulator Pin 12 Pin 13	I_{Pin}	– 3.0 to + 3.0 – 1.0 to + 0 15 35 – 1.0 to + 1.0 – 200	mA
Maximum Power Dissipation	P_{D}	1.0	W
Thermal Resistance, Junction–to–Air	$R_{\theta\text{JA}}$	65	$^\circ\text{C}/\text{W}$
Operating Junction Temperature	T_{J}	– 10 to + 120	$^\circ\text{C}$
Storage Temperature Range	T_{stg}	– 55 to + 150	$^\circ\text{C}$

ELECTRICAL CHARACTERISTICS ($T_A = 25^\circ\text{C}$)

Characteristic	Symbol	Min	Typ	Max	Unit
VOLTAGE REGULATOR					
Internally Regulated Voltage ($V_{\text{Pin 9}}$) ($I_{\text{Pin 7}} = 0$, $I_{\text{Pin 9}} + I_{\text{Pin 10}} = 15$ mA, $I_{\text{Pin 13}} = 0$)	V_{CC}	15	15.3	15.6	V
V_{CC} Temperature Factor	TF	—	– 100	—	ppm/ $^\circ\text{C}$
Current Consumption ($I_{\text{Pin 9}}$) ($V_{\text{g}} = 15$ V, $V_{12} = V_{\text{g}} = 0$, $I_1 = I_2 = 100$ μA , all other pins not connected)	I_{CC}	—	4.5	6.0	mA
V_{CC} Monitoring Enable Level	$V_{\text{CC EN}}$	—	$V_{\text{CC}} - 0.4$	—	V
V_{CC} Monitoring Disable Level	$V_{\text{CC DIS}}$	—	$V_{\text{CC}} - 1.0$	—	V
RAMP GENERATOR					
Reference Speed Input Voltage Range	$V_{\text{Pin 5}}$	0.08	—	13.5	V
Reference Input Bias Current	$-I_{\text{Pin 5}}$	0	0.8	1.0	μA
Ramp Selection Input Bias Current	$-I_{\text{Pin 6}}$	0	—	1.0	μA
Distribution Starting Level Range	V_{DS}	0	—	2.0	V
Distribution Final Level $V_{\text{Pin 6}} = 0.75$ V	$V_{\text{DF}}/V_{\text{DS}}$	2.0	2.09	2.2	
High Acceleration Charging Current $V_{\text{Pin 7}} = 0$ V $V_{\text{Pin 7}} = 10$ V	$-I_{\text{Pin 7}}$	1.0 1.0	— 1.2	1.7 1.4	mA
Distribution Charging Current $V_{\text{Pin 7}} = 2.0$ V	$-I_{\text{Pin 7}}$	4.0	5.0	6.0	μA

TDA1085C

ELECTRICAL CHARACTERISTICS (continued)

Characteristic	Symbol	Min	Typ	Max	Unit
CURRENT LIMITER					
Limiter Current Gain — $I_{Pin\ 7}/I_{Pin\ 3}$ ($I_{Pin\ 3} = -300\ \mu A$)	C_g	130	180	250	
Detection Threshold Voltage $I_{Pin\ 3} = -10\ \mu A$	$V_{Pin\ 3\ TH}$	50	65	80	mV
FREQUENCY TO VOLTAGE CONVERTER					
Input Signal "Low Voltage"	$V_{12\ L}$	-100	—	—	mV
Input Signal "High Voltage"	$V_{12\ H}$	+100	—	—	mV
Monitoring Reset Voltage	$V_{12\ R}$	5.0	—	—	V
Negative Clamping Voltage $I_{Pin\ 12} = -200\ \mu A$	$-V_{12\ CL}$	—	0.6	—	V
Input Bias Current	$-I_{Pin\ 12}$	—	25	—	μA
Internal Current Source Gain $G = \frac{I_{Pin\ 4}}{I_{Pin\ 11}}, V_{Pin\ 4} = V_{Pin\ 11} = 0$	G.0	9.5	—	11	
Gain Linearity versus Voltage on Pin 4 ($G_{8.6}$ = Gain for $V_{Pin\ 4} = 8.6\ V$) $V_4 = 0\ V$ $V_4 = 4.3\ V$ $V_4 = 12\ V$	G/ $G_{8.6}$	1.04 1.015 0.965	1.05 1.025 0.975	1.06 1.035 0.985	
Gain Temperature Effect ($V_{Pin\ 4} = 0$)	TF	—	350	—	ppm/ $^{\circ}C$
Output Leakage Current ($I_{Pin\ 11} = 0$)	$-I_{Pin\ 4}$	0	—	100	nA
CONTROL AMPLIFIER					
Actual Speed Input Voltage Range	$V_{Pin\ 4}$	0	—	13.5	V
Input Offset Voltage $V_{Pin\ 5} - V_{Pin\ 4}$ ($I_{Pin\ 16} = 0, V_{Pin\ 16} = 3.0$ and $8.0\ V$)	V_{off}	0	—	50	mV
Amplifier Transconductance ($I_{Pin\ 16}/\Delta(V_5 - V_4)$) ($I_{Pin\ 16} = +$ and $-50\ \mu A, V_{Pin\ 16} = 3.0\ V$)	T	270	340	400	$\mu A/V$
Output Current Swing Capability Source Sink	$I_{Pin\ 16}$	-200 50	-100 100	-50 200	μA
Output Saturation Voltage	$V_{16\ sat}$	—	—	0.8	V
TRIGGER PULSE GENERATOR					
Synchronization Level Currents Voltage Line Sensing Triac Sensing	$I_{Pin\ 2}$ $I_{Pin\ 1}$	— —	± 50 ± 50	± 100 ± 100	μA
Trigger Pulse Duration ($C_{Pin\ 14} = 47\ nF, R_{Pin\ 15} = 270\ k\Omega$)	T_p	—	55	—	μs
Trigger Pulse Repetition Period, conditions as a.m.	T_R	—	220	—	μs
Output Pulse Current $V_{Pin\ 13} = V_{CC} - 4.0\ V$	$-I_{Pin\ 13}$	180	192	—	mA
Output Leakage Current $V_{Pin\ 13} = -3.0\ V$	$I_{13\ L}$	—	—	30	μA
Full Angle Conduction Input Voltage	V_{14}	—	11.7	—	V
Saw Tooth "High" Level Voltage	$V_{14\ H}$	12	—	12.7	V
Saw Tooth Discharge Current, $I_{Pin\ 15} = 100\ \mu A$	$I_{Pin\ 14}$	95	—	105	μA

TDA1085C

GENERAL DESCRIPTION

The TDA 1085C triggers a triac accordingly to the speed regulation requirements. Motor speed is digitally sensed by a tachogenerator and then converted into an analog voltage.

The speed set is externally fixed and is applied to the internal linear regulation input after having been submitted to programmable acceleration ramps. The overall result consists in a full motor speed

range with two acceleration ramps which allow efficient washing machine control (Distribute function).

Additionally, the TDA 1085C protects the whole system against AC line stop or variations, overcurrent in the motor and tachogenerator failure.

INPUT/OUTPUT FUNCTIONS (Refer to Figures 1 and 8)

Voltage Regulator – (Pins 9 and 10) This is a parallel type regulator able to sink a large amount of current and offering good characteristics. Current flow is provided from AC line by external dropping resistors R1, R2, and rectifier. This half wave current is used to feed a smothering capacitor, the voltage of which is checked by the IC.

When V_{CC} is reached, the excess of current is derived by another dropping resistor R10 and by Pin 10. These three resistors must be determined in order:

- To let 1.0 mA flow through Pin 10 when AC line is minimum and V_{CC} consumption is maximum (fast ramps and pulses present).
- To let V_{I0} reach 3.0 V when AC line provides maximum current and V_{CC} consumption is minimum (no ramps and no pulses).
- All along the main line cycle, the Pin 10 dynamic range must not be exceeded unless loss of regulation.

An AC line supply failure would cause shut down.

The double capacitive filter built with R1 and R2 gives an efficient V_{CC} smoothing and helps to remove noise from set speeds.

Speed Sensing – (Pins 4, 11, 12) The IC is compatible with an external analog speed sensing: its output must be applied to Pin 4, and Pin 12 connected to Pin 8.

In most of the applications it is more convenient to use a digital speed sensing with an unexpensive tachogenerator which doesn't need any tuning. During every positive cycle at Pin 12, the capacitor $C_{Pin 11}$ is charged to almost V_{CC} and during this time, Pin 4 delivers a current which is 10 times the one charging $C_{Pin 11}$. The current source gain is called G and is tightly specified, but nevertheless requires an adjustment on $R_{Pin 4}$. The current into this resistor is proportional to $C_{Pin 11}$ and to the motor speed; being filtered by a capacitor, $V_{Pin 4}$ becomes smothered and represents the "true actual motor speed".

To maintain linearity into the high speed range, it is important to verify that $C_{Pin 11}$ is fully charged: the internal source on Pin 11 has 100 K Ω impedance. Nevertheless $C_{Pin 11}$ has to be as high as possible as it has a large influence on FV/C temperature factor. A 470 K Ω resistor between Pins 11 and 9 reduces leakage currents and temperature factor as well, down to neglectable effects.

Pin 12 also has a monitoring function: when its voltage is above 5.0 V, the trigger pulses are inhibited and the IC is reset. It also senses the tachogenerator continuity, and in case of any circuit aperture, it inhibits pulse, avoiding the motor to run out of control. In the TDA 1085C, Pin 12 is negatively clamped by an internal diode which removes the necessity of the external one used in the former circuit.

Ramp Generator – (Pins 5, 6, 7) The true Set Speed value taken in consideration by the regulation is the output of the ramp generator (Pin 7). With a given value of speed set input (Pin 5), the ramp generator charges an external capacitor $C_{Pin 7}$ up to the moment $V_{Pin 5}$ (set speed) equals $V_{Pin 4}$ (true speed), see Figure 2. The IC has an internal charging current source of 1.2mA and delivers it from 0 to 12 V at Pin 7. It is the high acceleration ramp (5.0 s typical) which allows rapid motor speed changes without excessive strains on the mechanics. In addition, the TDA 1085C offers the possibility to break this high acceleration with the introduction of a low acceleration ramp (called Distribution) by reducing the Pin 7 source current down to 5.0 μ A under Pin 6 full control, as shown by following conditions:

- Presence of high acceleration ramp $V_{Pin 5} > V_{Pin 4}$
- Distribution occurs in the $V_{Pin 4}$ range (true motor speed) defined by $V_{Pin 6} \cong V_{Pin 4} \cong 2.0 V_{Pin 6}$

For two fixed values of $V_{Pin 5}$ and $V_{Pin 6}$, the motor speed will have high acceleration, excluding the time for $V_{Pin 4}$ to go from $V_{Pin 6}$ to two times this value, high acceleration again, up to the moment the motor has reached the set speed value, at which it will stay, see Figure 3.

Should a reset happen (whatever the cause would be), the above mentioned successive ramps will be fully reprocessed from 0 to the maximum speed. If $V_{Pin 6} = 0$, only the high acceleration ramp occurs.

To get a real zero speed position, Pin 5 has been designed in such a way that its voltage from 0 to 80 mV is interpreted as a true zero. As a consequence, when changing the speed set position, the designer must be sure that any transient zero would not occur: if any, the entire circuit will be reset.

As the voltages applied by Pins 5 and 6 are derived from the internal voltage regulator supply and Pin 4 voltage is also derived from the same source, motor speed (which is determined by the ratios between above mentioned voltages) is totally independent from V_{CC} variations and temperature factor.

Control Amplifier – (Pin 16) It amplifies the difference between true speed (Pin 4) and set speed (Pin 5), through the ramp generator. Its output available at Pin 16 is a double sense current source with a maximum capability of $\pm 100 \mu$ A and a specified transconductance (340 μ A/V typical). Pin 16 drives directly the trigger pulse generator, and must be loaded by an electrical network which compensates the mechanical characteristics of the motor and its load, in order to provide stability in any condition and shortest transient response; see Figure 4.

This network must be adjusted experimentally.

In case of a periodic torque variations, Pin 16 directly provides the phase angle oscillations.

TDA1085C

Trigger Pulse Generator – (Pins 1, 2, 5, 13, 14, 15)

This circuit performs four functions:

- The conversion of the control amplifier DC output level to a proportional firing angle at every main line half cycle.
- The calibration of pulse duration.
- The repetition of the pulse if the triac fails to latch on if the current has been interrupted by brush bounce.
- The delay of firing pulse until the current crosses zero at wide firing angles and inductive loads.

R_{Pin 15} programs the Pin 14 discharging current. Saw tooth signal is then fully determined by R15 and C14 (usually 47 nF). Firing pulse duration and repetition period are in inverse ratio to the saw tooth slope.

Pin 13 is the pulse output and an external limiting resistor is mandatory. Maximum current capability is 200 mA.

Current Limiter – (Pin 3) Safe operation of the motor and triac under all conditions is ensured by limiting the peak current. The motor current develops an alternative voltage in the shunt resistor (0.05 Ω in Figure 4). The negative half waves are transferred to Pin 3 which is positively preset at a voltage determined by resistors R3 and R4. As motor current increases, the dynamical voltage range of Pin 3 increases and when Pin 3 becomes slightly negative in respect to Pin 8, a current starts to circulate in it. This current, amplified typically 180 times, is then used to discharge Pin 7 capacitor and, as a result, reduces firing angle down to a value where an equilibrium is reached. The choice of resistors R3, R4 and shunt determines the magnitude of the discharge current signals on C_{Pin 7}.

Notice that the current limiter acts only on peak triac current.

APPLICATION NOTES (Refer to Figure 4)

Printed Circuit Layout Rules

In the common applications, where TDA 1085C is used, there is on the same board, presence of high voltage, high currents as well as low voltage signals where millivolts count. It is of first magnitude importance to separate them from each other and to respect the following rules:

- Capacitor decoupling pins, which are the inputs of the same comparator, must be physically close to the IC, close to each other and grounded in the same point.
- Ground connection for tachogenerator must be directly connected to Pin 8 and should ground only the tacho. In effect, the latter is a first magnitude noise generator due to its proximity to the motor which induces high dφ/dt signals.
- The ground pattern must be in the “star style” in order to fully eliminate power currents flowing in the ground network devoted to capacitors decoupling sensitive Pins: 4, 5, 7, 11, 12, 14, 16.

As an example, Figure 5 presents a PC board pattern which concerns the group of sensitive Pins and their associated capacitors into which the a.m. rules have been implemented. Notice the full separation of “Signal World” from “Power”, one by line AB and their communication by a unique strip.

These rules will lead to much satisfactory volume production in the sense that speed adjustment will stay valid in the entire speed range.

Power Supply

As dropping resistor dissipates noticeable power, it is necessary to reduce the I_{CC} needs down to a minimum. Triggering pulses, if a certain number of repetitions are kept in reserve to cope with motor brush wearing at the end of its life, are the largest I_{CC} user. Classical worst case configuration has to be considered to select dropping resistor. In addition, the parallel regulator must be always into its dynamic range, i.e., I_{Pin 10} over 1.0 mA and V_{Pin 10} over 3.0 V in any extreme configuration. The double filtering cell is mandatory.

Tachogenerator Circuit

The tacho signal voltage is proportional to the motor speed. Stability considerations, in addition, require an RC filter, the pole of which must be looked at. The combination of both elements yield a constant amplitude signal on Pin 12 in most of the speed range. It is recommended to verify this maximum amplitude to be within 1.0 V peak in order to have the largest signal/noise ratio without resetting

the integrated circuit (which occurs if V_{Pin 12} reaches 5.5 V). It must be also verified that the Pin 12 signal is approximately balanced between “high” (over 300 mV) and “low”. An 8–poles tacho is a minimum for low speed stability and a 16–poles is even better.

The RC pole of the tacho circuit should be chosen within 30 Hz in order to be as far as possible from the 150 Hz which corresponds to the AC line 3rd harmonic generated by the motor during starting procedure. In addition, a high value resistor coming from V_{CC} introduces a positive offset at Pin 12, removes noise to be interpreted as a tacho signal. This offset should be designed in order to let Pin 12 reach at least –200 mV (negative voltage) at the lowest motor speed. We remember the necessity of an individual tacho ground connection.

Frequency to Voltage Converter – F/V/C

C_{Pin 11} has a recommended value of 820 pF for 8–poles tachos and maximum motor rpm of 15000, and R_{Pin 11} must be always 470 K.

R_{Pin 4} should be chosen to deliver within 12 V at maximum motor speed in order to maximize signal/noise ratio. As the FV/C ratio as well as the C_{Pin 11} value are dispersed, R_{Pin 4} must be adjustable and should be made of a fixed resistor in serie with a trimmer representing 25% of the total. Adjustment would become easier.

Once adjusted, for instance at maximum motor speed, the FV/C presents a residual non linearity; the conversion factor (mV per RPM) increases by within 7.7% as speed draws to zero. The guaranteed dispersion of the latter being very narrow, a maximum 1% speed error is guaranteed if during Pin 5 network design the small set values are modified, once forever, according this increase.

The following formulas give V_{Pin 4}:

$$V_{\text{Pin 4}} = G.0 \cdot (V_{\text{CC}} - V_a) \cdot C_{\text{Pin 11}} \cdot R_4 \cdot f \cdot \frac{1}{\left(1 + \frac{120k}{R_{\text{Pin 11}}}\right)} \text{ In volts.}$$

$$G.0 \cdot (V_{\text{CC}} - V_a) \simeq 140$$

$$V_a = 2.0 \text{ VBE}$$

$$120 \text{ k} = R_{\text{int. on Pin 11}}$$

Speed Set – (Pin 5) Upon designer choice, a set of external resistors apply a series of various voltages corresponding to the various motor speeds. When switching external resistors, verify that no voltage below 80 mV is ever applied to Pin 5. If so, a full circuit reset will occur.

Ramps Generator – (Pin 6) If only a high acceleration ramp is needed, connect Pin 6 to ground.

When a Distribute ramp should occur, preset a voltage on Pin 6 which corresponds to the motor speed starting ramp point. Distribution (or low ramp) will continue up to the moment the motor speed would have reached twice the starting value.

The ratio of two is imposed by the IC. Nevertheless, it could be externally changed downwards (Figure 6) or upwards (Figure 7).

The distribution ramp can be shortened by an external resistor from V_{CC} charging $C_{Pin\ 7}$, adding its current to the internal $5.0\ \mu A$ generator.

Power Circuits

Triac Triggering pulse amplitude must be determined by Pin 13 resistor according to the needs in Quadrant IV. Trigger pulse duration can be disturbed by noise signals generated by the triac itself, which interfere within Pins 14 and 16, precisely those which determine it. While easily visible, this effect is harmless.

The triac must be protected from high AC line dV/dt during external disturbances by $100\ nF \times 100\ \Omega$ network.

Shunt resistor must be as non-inductive as possible. It can be made locally by using constantan alloy wire.

When the load is a DC fed universal motor through a rectifier bridge, the triac must be protected from commutating dV/dt by a 1.0 to 2.0 mH coil in series with MT_2 .

Synchronization functions are performed by resistors sensing AC line and triac conduction. 820 k values are normal but could be reduced down to 330 k in order to detect the "zeros" with accuracy and to reduce the residual DC line component below 20 mA.

Current Limitation

The current limiter starts to discharge Pin 7 capacitor (reference speed) as the motor current reaches the designed threshold level. The loop gain is determined by the resistor connecting Pin 3 to the series shunt. Experience has shown that its optimal value for a 10 Arms limitation is within $2.0\ k\Omega$. Pin 3 input has a sensitivity in current which is limited to reasonable values and should not react to spikes.

If not used, Pin 3 must be connected to a maximum positive voltage of 5.0 V rather than be left open.

Loop Stability

The Pin 16 network is predominant and must be adjusted experimentally during module development. The values indicated in Figure 4 are typical for washing machine applications but accept large modifications from one model to another. R16 (the sole restriction) should not go below 33 k, otherwise slew rate limitation will cause large transient errors for load steps.

Figure 2. Acceleration Ramp

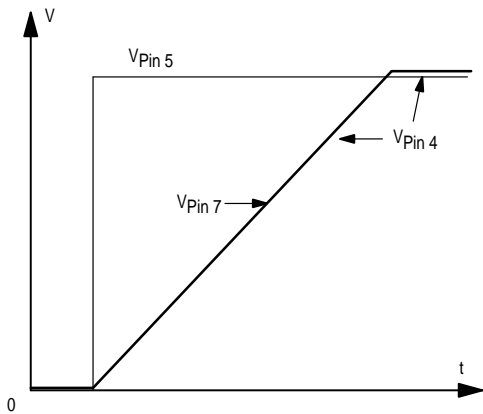
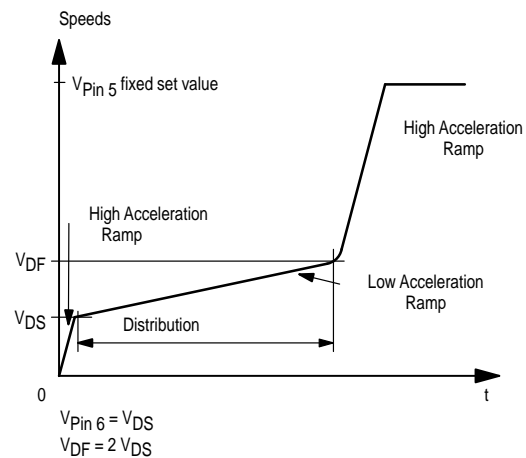
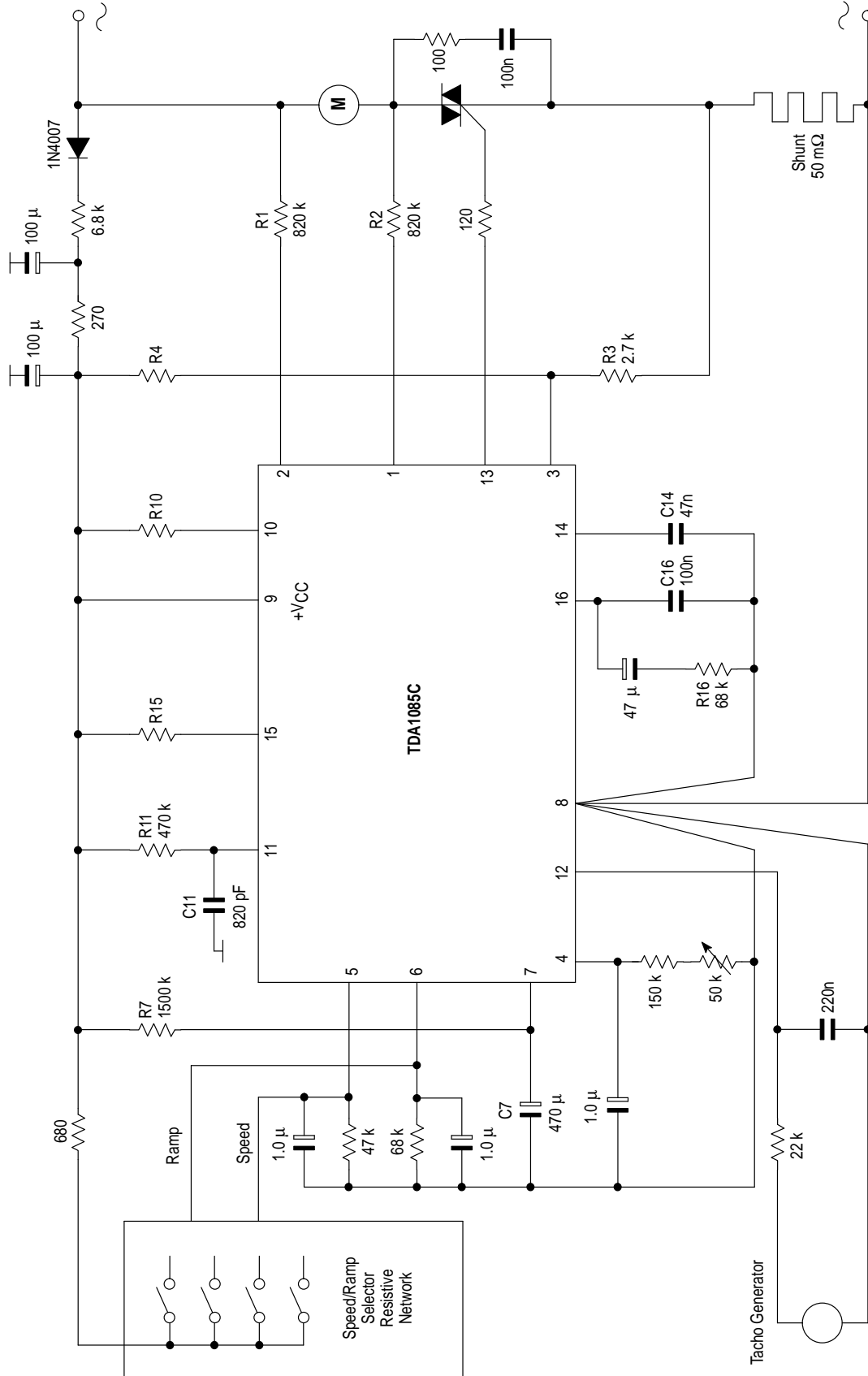

Figure 3. Programmable Double Acceleration Ramp



TDA1085C

Figure 4. Basic Application Circuit



Motor Speed Range: 0 to 15,000 rpm
 Tachogenerator 8 poles delivering 30 V peak to peak at 6000 rpm, in open circuit
 FV/C Factor: 8 mV per rpm (12 V full speed) C_{Pin 11} = 680 pF V_{CC} = 15.3 V
 Triac MAX15A-8 15 A 600 V
 Igt min = 90 mA to cover Quad IV at -10°C

Current limitation: 10 A adjusted by R4 experimentally
 Ramps High acceleration: 3200 rpm per second
 Distribution ramp: 10 s from 850 to 1300 rpm
Speeds:
 Wash 800 rpm Including nonlinearity corrections
 Distribution 1300 996 mV Including nonlinearity corrections
 Spin 1: 7500 5.912 V Including nonlinearity corrections
 Spin 2: 15,000 12,000 V Adjustment point

Pin 5 Voltage Set:
 609 mV Including nonlinearity corrections
 996 mV Including nonlinearity corrections
 5.912 V Including nonlinearity corrections
 12,000 V Adjustment point

TDA1085C

Figure 5. PC Board Layout

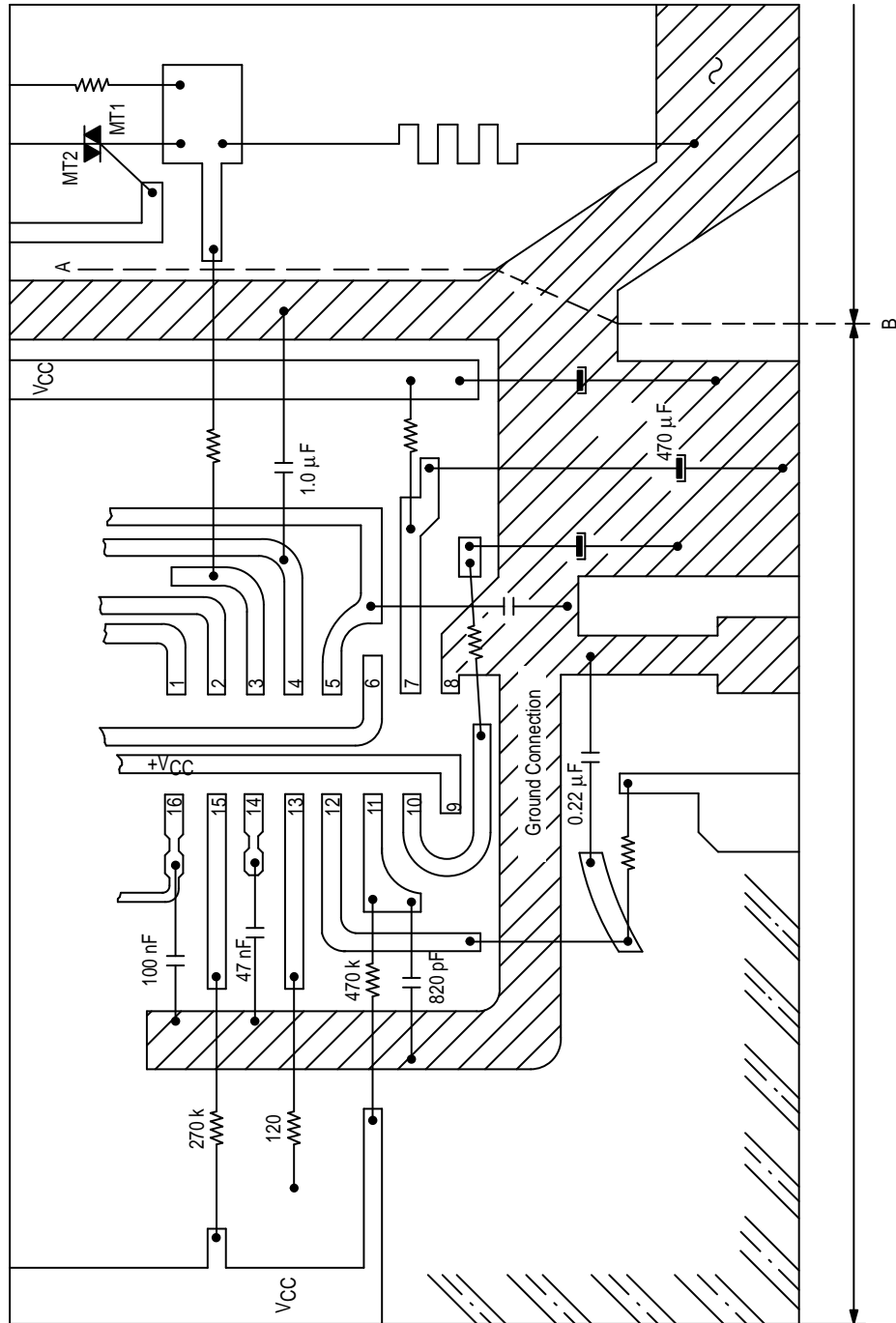

TDA1085C

Figure 6. Distribution Speed $k < 2$

For $k = 1.6$, $R_3 = 0.6 (R_1 + R_2)$,
 $R_3 C$ within 4 seconds

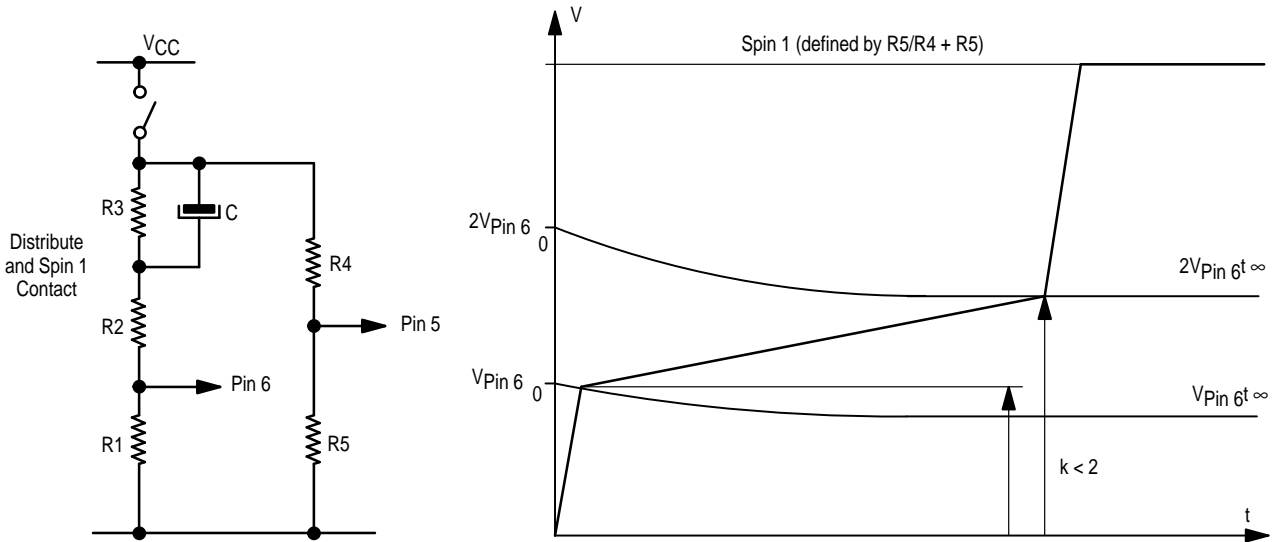
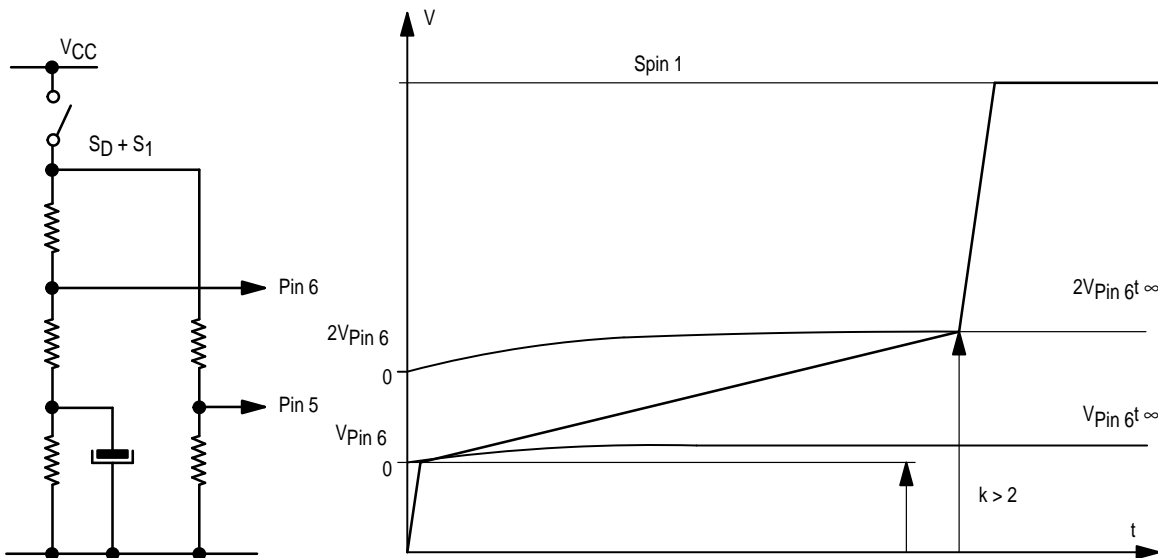
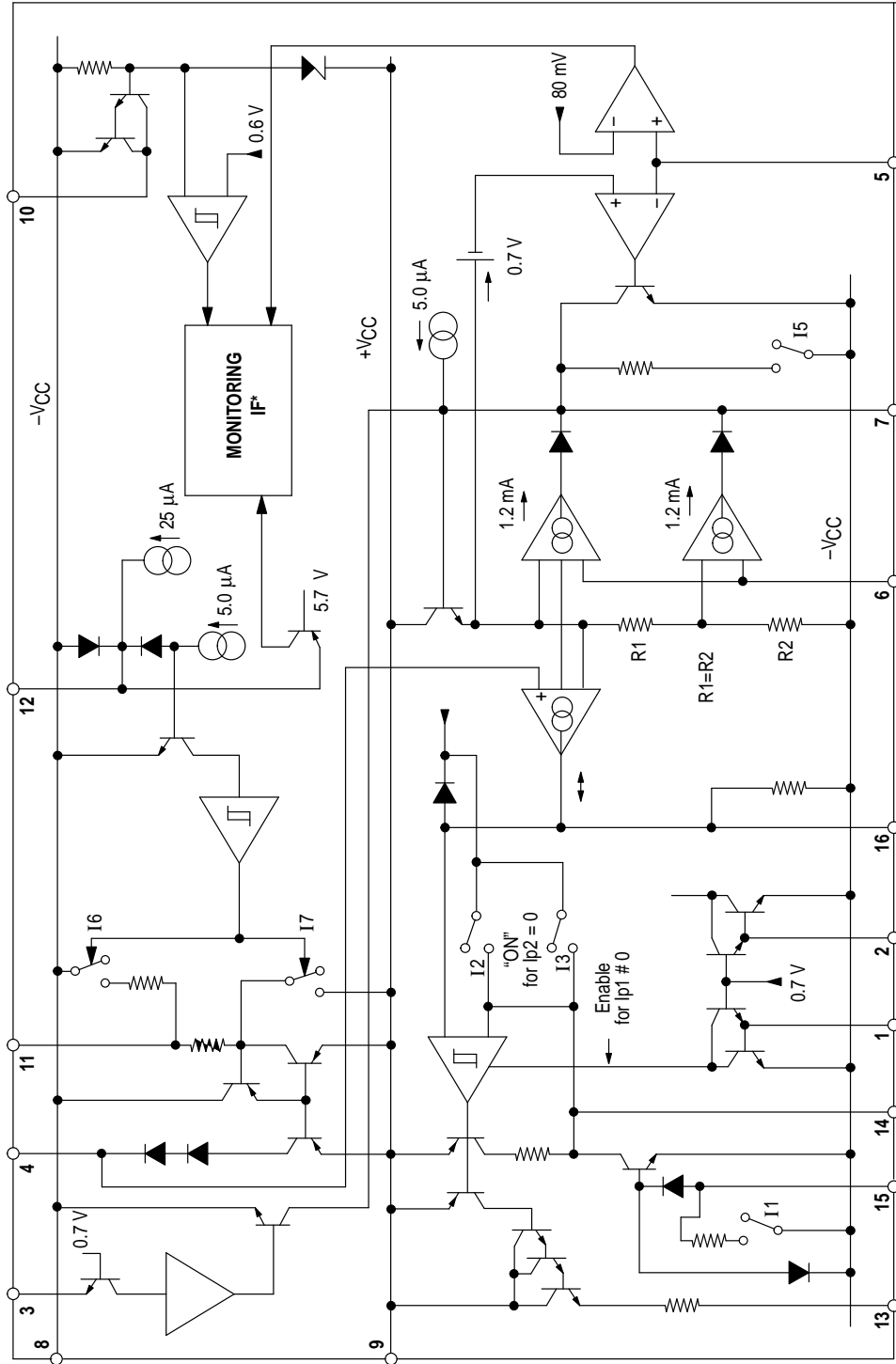

Figure 7. Distribution Speed $k > 2$



TDA1085C

Figure 8. Simplified Schematic



* (P12 connected) and (V_{CC}OK) and (VP5>80 mV)
Then
(I1 OFF), (I2 OFF), (I4 OFF) and (I5 OFF)

TDA1085C

OUTLINE DIMENSIONS

PLASTIC PACKAGE
CASE 648-08
ISSUE R

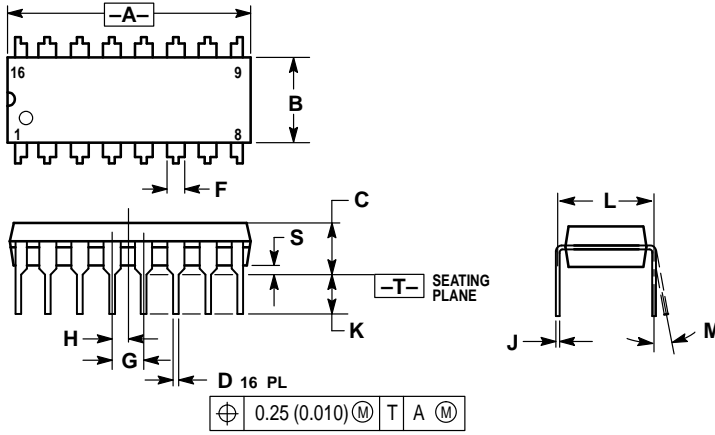

NOTES:

1. DIMENSIONING AND TOLERANCING PER ANSI Y14.5M, 1982.
2. CONTROLLING DIMENSION: INCH.
3. DIMENSION L TO CENTER OF LEADS WHEN FORMED PARALLEL.
4. DIMENSION B DOES NOT INCLUDE MOLD FLASH.
5. ROUNDED CORNERS OPTIONAL.

DIM	INCHES		MILLIMETERS	
	MIN	MAX	MIN	MAX
A	0.740	0.770	18.80	19.55
B	0.250	0.270	6.35	6.85
C	0.145	0.175	3.69	4.44
D	0.015	0.021	0.39	0.53
F	0.040	0.70	1.02	1.77
G	0.100 BSC		2.54 BSC	
H	0.050 BSC		1.27 BSC	
J	0.008	0.015	0.21	0.38
K	0.110	0.130	2.80	3.30
L	0.295	0.305	7.50	7.74
M	0° 10°		0° 10°	
S	0.020	0.040	0.51	1.01

D SUFFIX
PLASTIC PACKAGE
CASE 751B-05
ISSUE J
(SO-16)

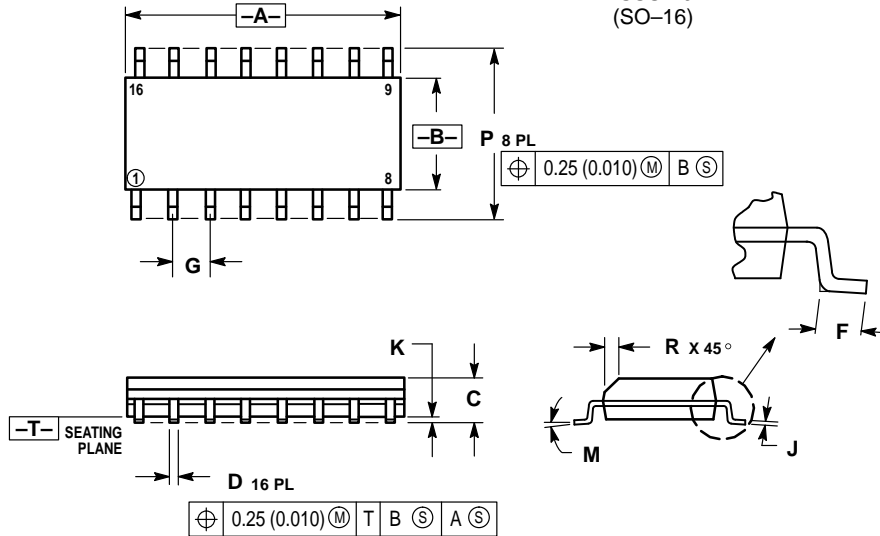

NOTES:

1. DIMENSIONING AND TOLERANCING PER ANSI Y14.5M, 1982.
2. CONTROLLING DIMENSION: MILLIMETER.
3. DIMENSIONS A AND B DO NOT INCLUDE MOLD PROTRUSION.
4. MAXIMUM MOLD PROTRUSION 0.15 (0.006) PER SIDE.
5. DIMENSION D DOES NOT INCLUDE DAMBAR PROTRUSION. ALLOWABLE DAMBAR PROTRUSION SHALL BE 0.127 (0.005) TOTAL IN EXCESS OF THE D DIMENSION AT MAXIMUM MATERIAL CONDITION.

DIM	MILLIMETERS		INCHES	
	MIN	MAX	MIN	MAX
A	9.80	10.00	0.386	0.393
B	3.80	4.00	0.150	0.157
C	1.35	1.75	0.054	0.068
D	0.35	0.49	0.014	0.019
F	0.40	1.25	0.016	0.049
G	1.27 BSC		0.050 BSC	
J	0.19	0.25	0.008	0.009
K	0.10	0.25	0.004	0.009
M	0° 7°		0° 7°	
P	5.80	6.20	0.229	0.244
R	0.25	0.50	0.010	0.019

TDA1085C

Motorola reserves the right to make changes without further notice to any products herein. Motorola makes no warranty, representation or guarantee regarding the suitability of its products for any particular purpose, nor does Motorola assume any liability arising out of the application or use of any product or circuit, and specifically disclaims any and all liability, including without limitation consequential or incidental damages. "Typical" parameters which may be provided in Motorola data sheets and/or specifications can and do vary in different applications and actual performance may vary over time. All operating parameters, including "Typicals" must be validated for each customer application by customer's technical experts. Motorola does not convey any license under its patent rights nor the rights of others. Motorola products are not designed, intended, or authorized for use as components in systems intended for surgical implant into the body, or other applications intended to support or sustain life, or for any other application in which the failure of the Motorola product could create a situation where personal injury or death may occur. Should Buyer purchase or use Motorola products for any such unintended or unauthorized application, Buyer shall indemnify and hold Motorola and its officers, employees, subsidiaries, affiliates, and distributors harmless against all claims, costs, damages, and expenses, and reasonable attorney fees arising out of, directly or indirectly, any claim of personal injury or death associated with such unintended or unauthorized use, even if such claim alleges that Motorola was negligent regarding the design or manufacture of the part. Motorola and  are registered trademarks of Motorola, Inc. Motorola, Inc. is an Equal Opportunity/Affirmative Action Employer.

How to reach us:

USA/EUROPE/Locations Not Listed: Motorola Literature Distribution;
P.O. Box 20912; Phoenix, Arizona 85036. 1-800-441-2447 or 602-303-5454

MFAX: RMFAX0@email.sps.mot.com – TOUCHTONE 602-244-6609
INTERNET: <http://Design-NET.com>

JAPAN: Nippon Motorola Ltd.; Tatsumi-SPD-JLDC, 6F Seibu-Butsuryu-Center,
3-14-2 Tatsumi Koto-Ku, Tokyo 135, Japan. 03-81-3521-8315

ASIA/PACIFIC: Motorola Semiconductors H.K. Ltd.; 8B Tai Ping Industrial Park,
51 Ting Kok Road, Tai Po, N.T., Hong Kong. 852-26629298



TDA1085C/D

