

MITSUBISHI Nch POWER MOSFET

# FS5KM-18A

HIGH-SPEED SWITCHING USE

## FS5KM-18A



- $V_{DSS}$  ..... 900V
- $r_{DS(ON)}(MAX)$  .....  $2.8\Omega$
- $I_D$  ..... 5A
- $V_{iso}$  ..... 2000V

## OUTLINE DRAWING

Dimensions in mm

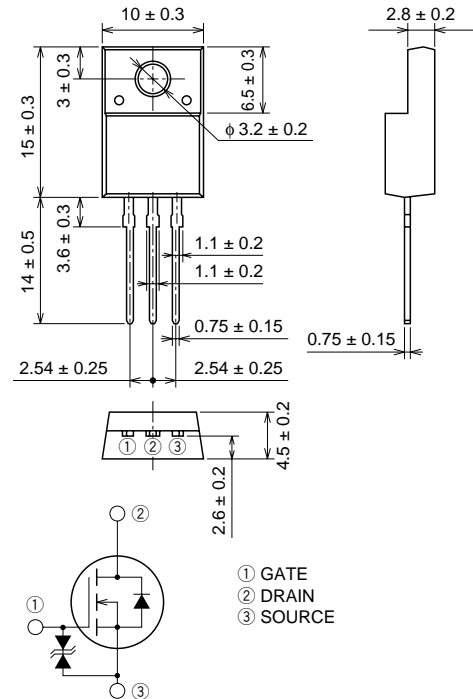

TO-220FN

## APPLICATION

SMPS, DC-DC Converter, battery charger, power supply of printer, copier, HDD, FDD, TV, VCR, personal computer etc.

## MAXIMUM RATINGS (T<sub>c</sub> = 25°C)

Symbol	Parameter	Conditions	Ratings	Unit
$V_{DSS}$	Drain-source voltage	$V_{GS} = 0V$	900	V
$V_{GSS}$	Gate-source voltage	$V_{DS} = 0V$	$\pm 30$	V
$I_D$	Drain current		5	A
$I_{DM}$	Drain current (Pulsed)		15	A
$P_D$	Maximum power dissipation		30	W
$T_{ch}$	Channel temperature		-55 ~ +150	°C
$T_{stg}$	Storage temperature		-55 ~ +150	°C
$V_{iso}$	Isolation voltage	AC for 1 minute, Terminal to case	2000	V <sub>rms</sub>
—	Weight	Typical value	2	g

Feb.1999

# FS5KM-18A

HIGH-SPEED SWITCHING USE

## ELECTRICAL CHARACTERISTICS (T<sub>ch</sub> = 25°C)

Symbol	Parameter	Test conditions	Limits			Unit
			Min.	Typ.	Max.	
V (BR) DSS	Drain-source breakdown voltage	I <sub>D</sub> = 1mA, V <sub>GS</sub> = 0V	900	—	—	V
V (BR) GSS	Gate-source breakdown voltage	I <sub>GS</sub> = ±100μA, V <sub>DS</sub> = 0V	±30	—	—	V
I <sub>GSS</sub>	Gate-source leakage current	V <sub>GS</sub> = ±25V, V <sub>DS</sub> = 0V	—	—	±10	μA
I <sub>DSS</sub>	Drain-source leakage current	V <sub>DS</sub> = 900V, V <sub>GS</sub> = 0V	—	—	1	mA
V <sub>GS(th)</sub>	Gate-source threshold voltage	I <sub>D</sub> = 1mA, V <sub>DS</sub> = 10V	2	3	4	V
r <sub>DS(ON)</sub>	Drain-source on-state resistance	I <sub>D</sub> = 2A, V <sub>GS</sub> = 10V	—	2.15	2.80	Ω
V <sub>DS(ON)</sub>	Drain-source on-state voltage	I <sub>D</sub> = 2A, V <sub>GS</sub> = 10V	—	4.30	5.60	V
y <sub>fs</sub>	Forward transfer admittance	I <sub>D</sub> = 2A, V <sub>DS</sub> = 10V	3.0	5.0	—	S
C <sub>iss</sub>	Input capacitance	V <sub>DS</sub> = 25V, V <sub>GS</sub> = 0V, f = 1MHz	—	1050	—	pF
C <sub>oss</sub>	Output capacitance		—	100	—	pF
C <sub>rss</sub>	Reverse transfer capacitance		—	20	—	pF
t <sub>d(on)</sub>	Turn-on delay time		—	20	—	ns
t <sub>r</sub>	Rise time	V <sub>DD</sub> = 200V, I <sub>D</sub> = 2A, V <sub>GS</sub> = 10V, R <sub>GEN</sub> = R <sub>GS</sub> = 50Ω	—	18	—	ns
t <sub>d(off)</sub>	Turn-off delay time		—	110	—	ns
t <sub>f</sub>	Fall time		—	35	—	ns
V <sub>SD</sub>	Source-drain voltage	I <sub>S</sub> = 2A, V <sub>GS</sub> = 0V	—	1.0	1.5	V
R <sub>th(ch-c)</sub>	Thermal resistance	Channel to case	—	—	4.17	°C/W

## PERFORMANCE CURVES

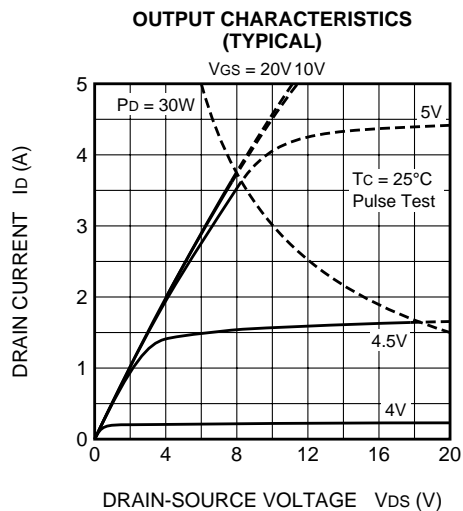
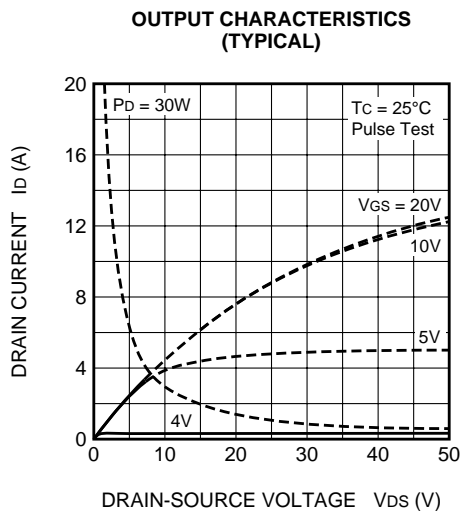
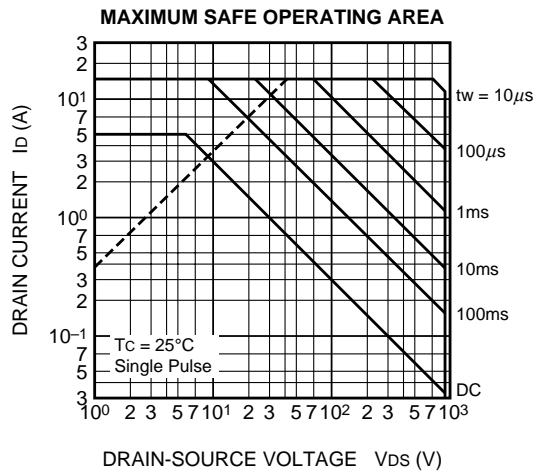
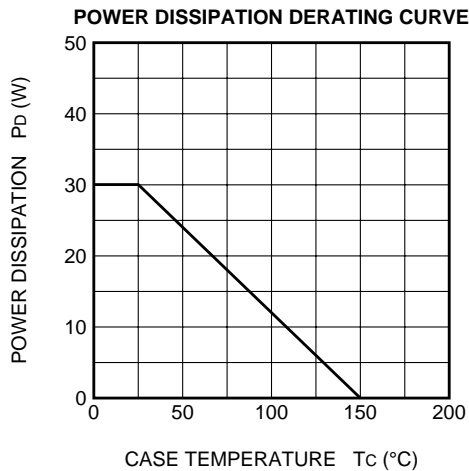

ON-STATE VOLTAGE VS. GATE-SOURCE VOLTAGE (TYPICAL)

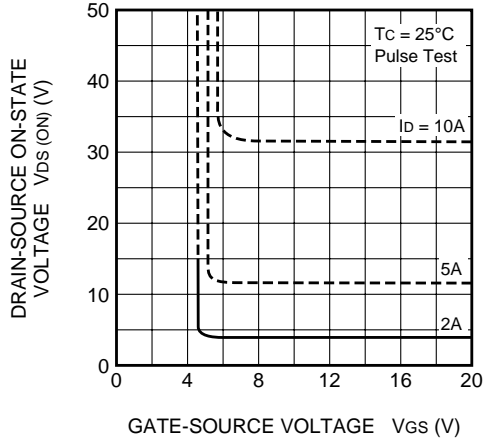

ON-STATE RESISTANCE VS. DRAIN CURRENT (TYPICAL)

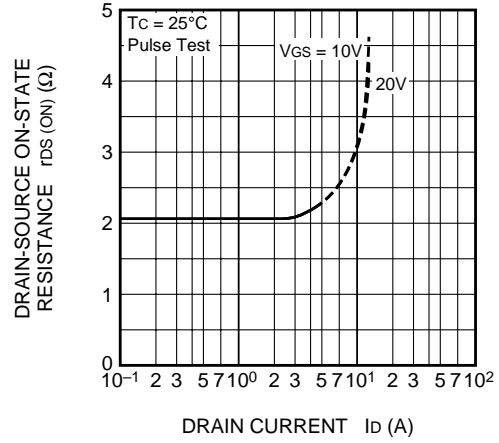

TRANSFER CHARACTERISTICS (TYPICAL)

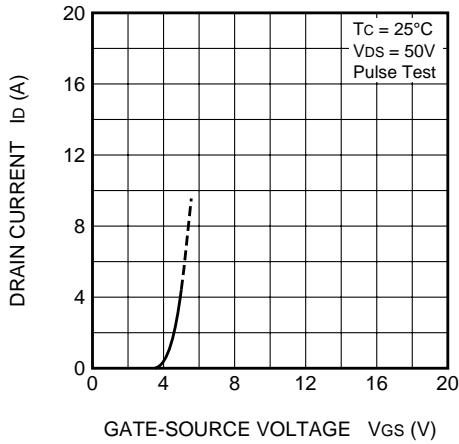

FORWARD TRANSFER ADMITTANCE VS. DRAIN CURRENT (TYPICAL)

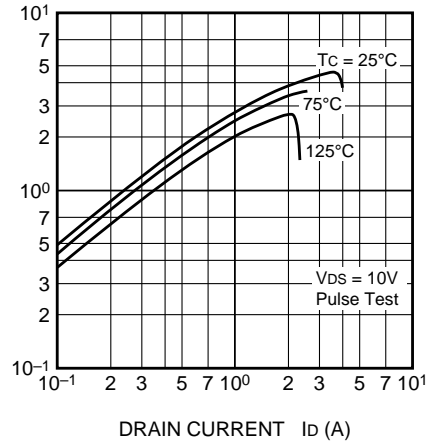

CAPACITANCE VS. DRAIN-SOURCE VOLTAGE (TYPICAL)

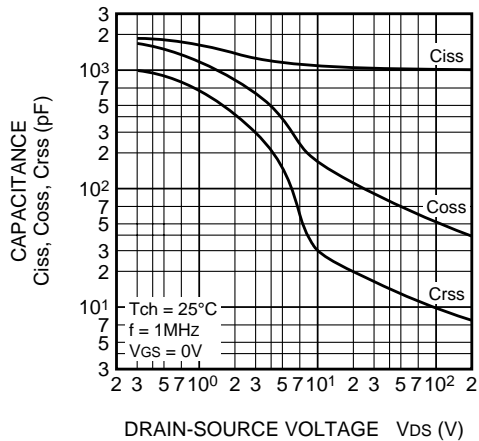

SWITCHING CHARACTERISTICS (TYPICAL)

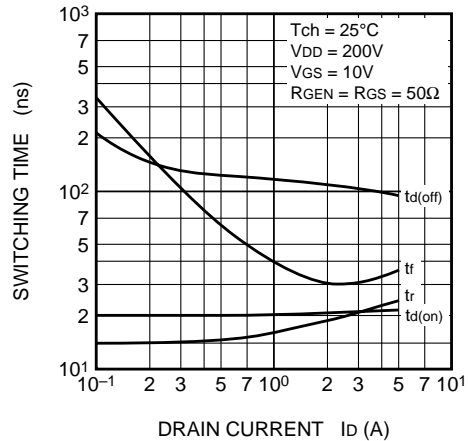

GATE-SOURCE VOLTAGE VS. GATE CHARGE (TYPICAL)

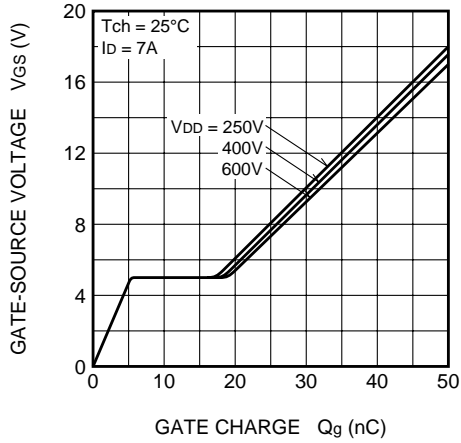

SOURCE-DRAIN DIODE FORWARD CHARACTERISTICS (TYPICAL)

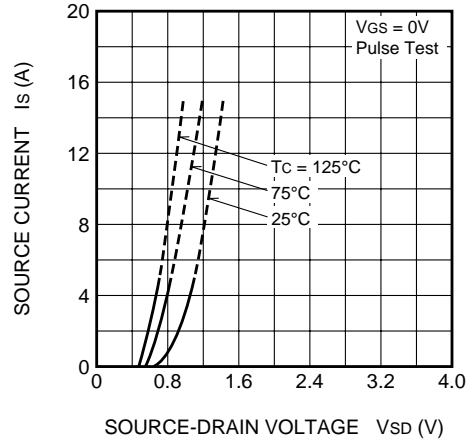

ON-STATE RESISTANCE VS. CHANNEL TEMPERATURE (TYPICAL)

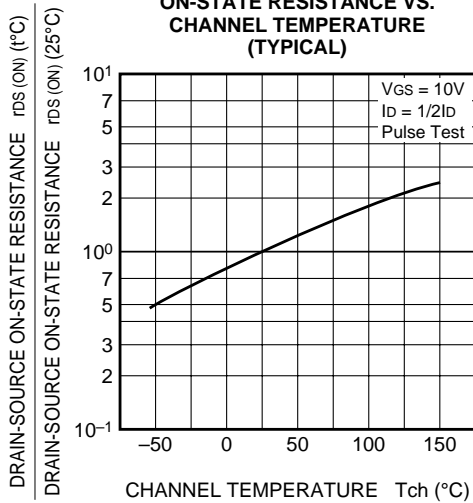

THRESHOLD VOLTAGE VS. CHANNEL TEMPERATURE (TYPICAL)

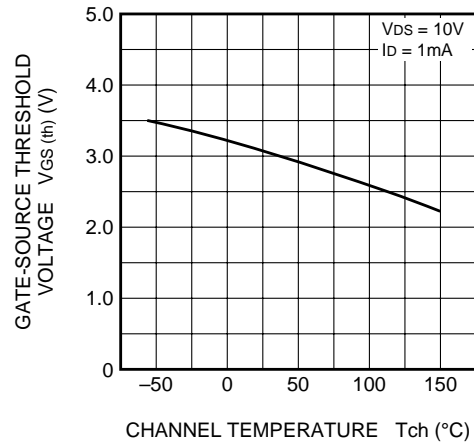

BREAKDOWN VOLTAGE VS. CHANNEL TEMPERATURE (TYPICAL)

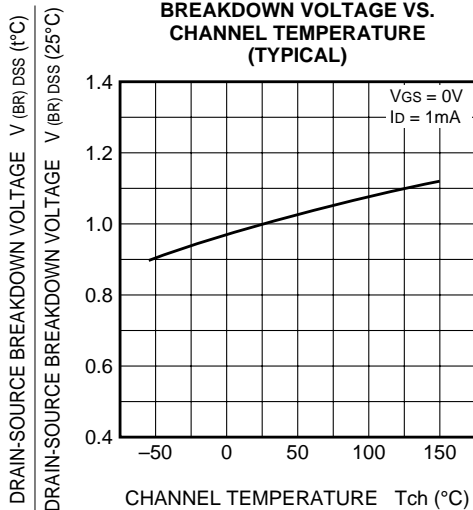

TRANSIENT THERMAL IMPEDANCE CHARACTERISTICS

