

MAXIM**Low-Cost, +5V, Serial-Input,
Voltage-Output, 16-Bit DAC****MAX5541****General Description**

The MAX5541 serial-input, voltage-output, 16-bit monotonic digital-to-analog converter (DAC) operates from a single +5V supply. The DAC output is unbuffered, resulting in low 0.3mA supply current and low 1LSB offset error. The DAC output range is 0V to VREF. The DAC latch accepts a 16-bit serial word. A power-on reset circuit clears the DAC output to 0V (unipolar mode) when power is initially applied.

The 10MHz 3-wire serial interface is SPI™/QSPI™/MICROWIRE™ compatible and interfaces directly with optocouplers for applications requiring isolation. The MAX5541 is available in an 8-pin SO package.

Features

- ◆ Full 16-Bit Performance Without Adjustments
- ◆ +5V Single-Supply Operation
- ◆ Low Power: 1.5mW
- ◆ 1µs Settling Time
- ◆ Unbuffered Voltage Output Directly Drives 60kΩ Loads
- ◆ SPI/QSPI/MICROWIRE-Compatible Serial Interface
- ◆ Power-On Reset Circuit Clears DAC Output to 0V (unipolar mode)
- ◆ Schmitt Trigger Inputs for Direct Optocoupler Interface

Applications

High-Resolution Offset and Gain Adjustment
Industrial Process Control
Automated Test Equipment
Data Acquisition Systems

Ordering Information

PART	TEMP. RANGE	PIN-PACKAGE
MAX5541CSA	0°C to +70°C	8 SO
MAX5541ESA	-40°C to +85°C	8 SO

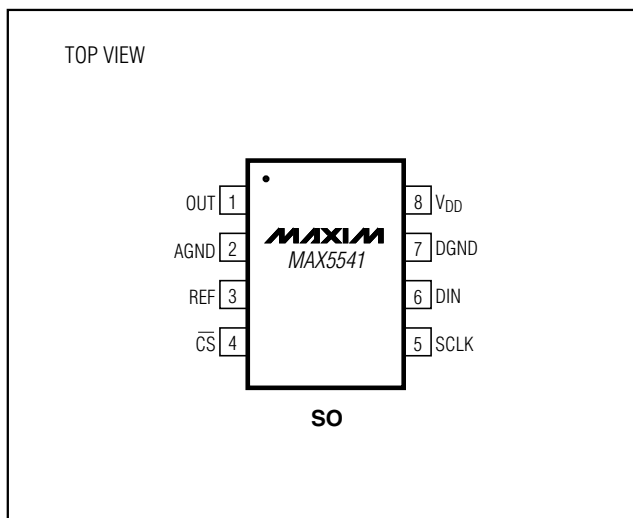
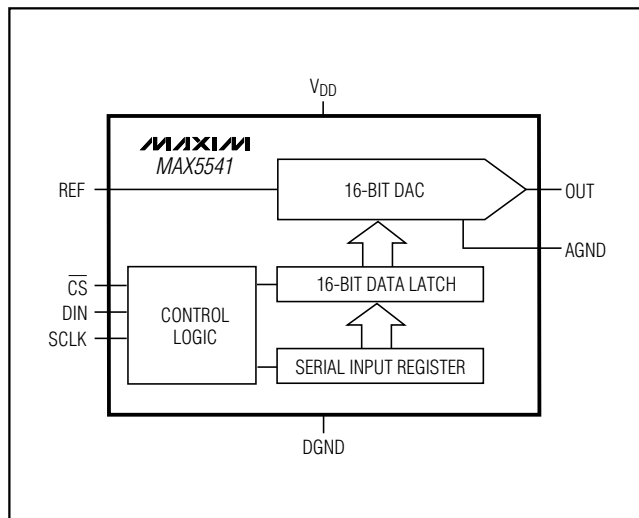
Pin Configuration**Functional Diagram**

SPI and QSPI are trademarks of Motorola, Inc.
MICROWIRE is a trademark of National Semiconductor Corp.

MAXIM

Maxim Integrated Products 1

**For free samples & the latest literature: <http://www.maxim-ic.com>, or phone 1-800-998-8800.
For small orders, phone 1-800-835-8769.**

Low-Cost, +5V, Serial-Input, Voltage-Output, 16-Bit DAC

ABSOLUTE MAXIMUM RATINGS

V _{DD} to DGND	-0.3V to +6V
CS, SCLK, DIN to DGND	-0.3V to +6V
REF to AGND, DGND	-0.3V to (V _{DD} + 0.3V)
AGND to DGND	-0.3V to +0.3V
OUT to AGND, DGND	-0.3V to V _{DD}
Maximum Current into Any Pin	50mA
Continuous Power Dissipation (T _A = +70°C)	
8-Pin SO (derate 5.88mW/°C above +70°C)	471mW

Operating Temperature Ranges

MAX5541CSA	0°C to +70°C
MAX5541ESA	-40°C to +85°C
Junction Temperature	+150°C
Storage Temperature Range	-65°C to +150°C
Lead Temperature (soldering, 10sec)	+300°C

Stresses beyond those listed under "Absolute Maximum Ratings" may cause permanent damage to the device. These are stress ratings only, and functional operation of the device at these or any other conditions beyond those indicated in the operational sections of the specifications is not implied. Exposure to absolute maximum rating conditions for extended periods may affect device reliability.

ELECTRICAL CHARACTERISTICS

(V_{DD} = +5V ±5%, V_{REF} = +2.5V, V_{AGND} = V_{DGND} = 0, T_A = T_{MIN} to T_{MAX}, unless otherwise noted. Typical values are at T_A = +25°C.)

PARAMETER	SYMBOL	CONDITIONS	MIN	TYP	MAX	UNITS
STATIC PERFORMANCE—ANALOG SECTION (R_L = ∞)						
Resolution	N		16			Bits
Differential Nonlinearity	DNL	Guaranteed monotonic		±0.5	±1.0	Bits
Integral Nonlinearity	INL	V _{DD} = 5V		±4	±16	LSB
Zero-Code Offset Error	ZSE	T _A = +25°C			±1	LSB
		T _A = T _{MIN} to T _{MAX}			±2	
Zero-Code Tempco	ZSTC	T _A = T _{MIN} to T _{MAX}		±0.05		ppm/°C
Gain Error (Note 1)		T _A = +25°C			±5	LSB
		T _A = T _{MIN} to T _{MAX}			±10	
Gain-Error Tempco				±0.1		ppm/°C
DAC Output Resistance	R _{OUT}	(Note 2)		6.25		kΩ
Power-Supply Rejection	PSR	4.75V ≤ V _{DD} ≤ 5.25V			±1.0	LSB
REFERENCE INPUT						
Reference Input Range	V _{REF}	(Note 3)	2.0		3.0	V
Reference Input Resistance (Note 4)	R _{REF}		11.5			kΩ
DYNAMIC PERFORMANCE—ANALOG SECTION (R_L = ∞)						
Voltage-Output Slew Rate	SR	C _L = 10pF (Note 5)		25		V/μs
Output Settling Time		To ±1/2LSB of FS, C _L = 10pF		1		μs

Low-Cost, +5V, Serial-Input, Voltage-Output, 16-Bit DAC

MAX5541

ELECTRICAL CHARACTERISTICS (continued)

($V_{DD} = +5V \pm 5\%$, $V_{REF} = +2.5V$, $V_{AGND} = V_{DGND} = 0$, $T_A = T_{MIN}$ to T_{MAX} , unless otherwise noted. Typical values are at $T_A = +25^\circ C$.)

PARAMETER	SYMBOL	CONDITIONS	MIN	TYP	MAX	UNITS
DAC Glitch Impulse		Major-carry transition		10		nVs
Digital Feedthrough		Code = 0000 hex, $\overline{CS} = V_{DD}$, SCLK = $V_{DIN} = 0$ to V_{DD} levels		10		nVs
DYNAMIC PERFORMANCE—REFERENCE SECTION						
Reference -3dB Bandwidth	BW	Code = FFFF hex		1		MHz
Reference Feedthrough		Code = 0000 hex, $V_{REF} = 1V_{p-p}$ at 100kHz		1		mVp-p
Signal-to-Noise Ratio	SNR			92		dB
Reference Input Capacitance	C_{IN}	Code = 0000 hex		75		pF
		Code = FFFF hex		120		
STATIC PERFORMANCE—DIGITAL INPUTS						
Input High Voltage	V_{IH}		2.4			V
Input Low Voltage	V_{IL}				0.8	V
Input Current	I_{IN}	$V_{IN} = 0$			± 1	μA
Input Capacitance	C_{IN}	(Note 6)			10	pF
Hysteresis Voltage	V_H			0.40		V
POWER SUPPLY						
Positive Supply Range	V_{DD}		4.75		5.25	V
Positive Supply Current	I_{DD}			0.3	1.1	mA
Power Dissipation	PD			1.5		mW

TIMING CHARACTERISTICS

($V_{DD} = +5V \pm 5\%$, $V_{REF} = +2.5V$, $V_{AGND} = V_{DGND} = 0$, CMOS inputs, $T_A = T_{MIN}$ to T_{MAX} , unless otherwise noted.)

PARAMETER	SYMBOL	CONDITIONS	MIN	TYP	MAX	UNITS
SCLK Frequency	f_{CLK}				10	MHz
SCLK Pulse Width High	t_{CH}		45			ns
SCLK Pulse Width Low	t_{CL}		45			ns
\overline{CS} Low to SCLK High Setup	t_{CSS0}		45			ns
\overline{CS} High to SCLK High Setup	t_{CSS1}		45			ns
SCLK High to \overline{CS} Low Hold	t_{CSH0}	(Note 6)	30			ns
SCLK High to \overline{CS} High Hold	t_{CSH1}		45			ns
DIN to SCLK High Setup	t_{DS}		40			ns
DIN to SCLK High Hold	t_{DH}		0			ns
V_{DD} High to \overline{CS} Low (power-up delay)				20		μs

Note 1: Gain Error tested at $V_{REF} = +2.0V$, $+2.5V$, and $+3.0V$.

Note 2: R_{OUT} tolerance is typically $\pm 20\%$.

Note 3: Min/Max ranges guaranteed by gain-error test. Operation outside min/max limits will result in degraded performance.

Note 4: Reference input resistance is code dependent, minimum at 8555 hex.

Note 5: Slew-rate value is measured from 0% to 63%.

Note 6: Guaranteed by design. Not production tested.

Low-Cost, +5V, Serial-Input, Voltage-Output, 16-Bit DAC

Typical Operating Characteristics

(VDD = +5V, VREF = +2.5V, TA = +25°C, unless otherwise noted.)

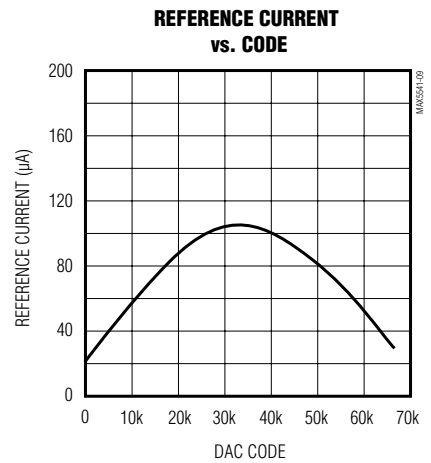
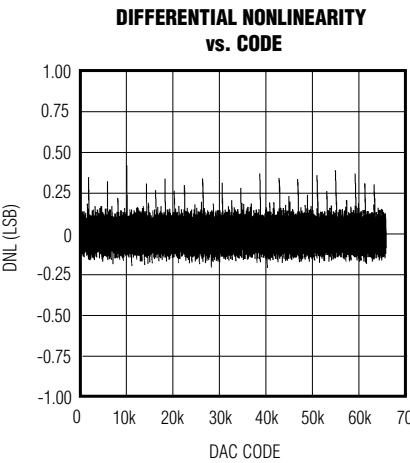
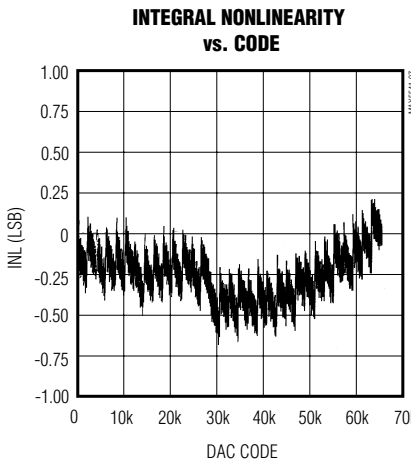
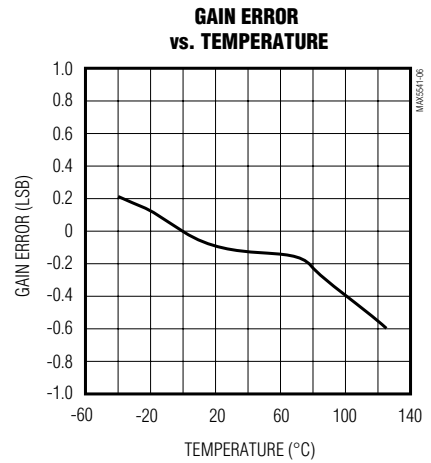
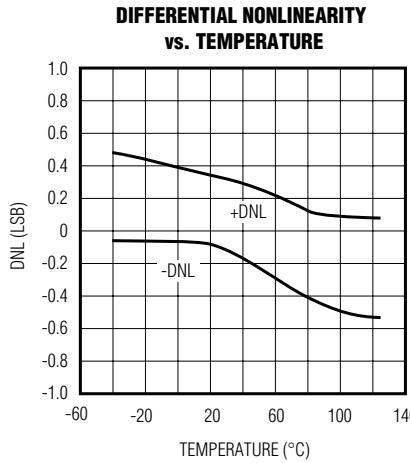
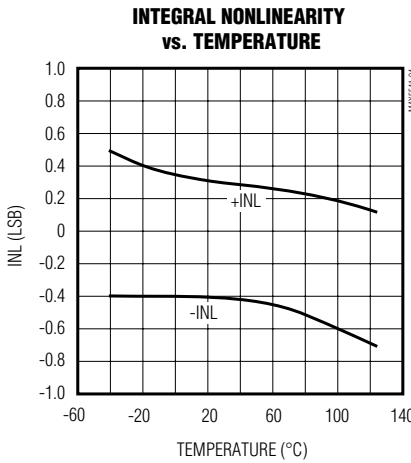
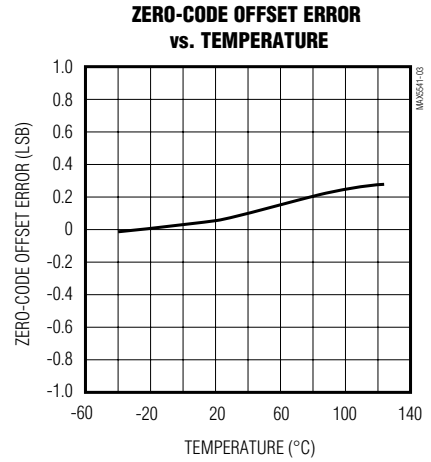
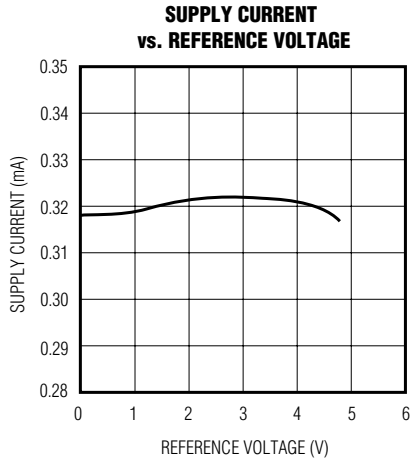
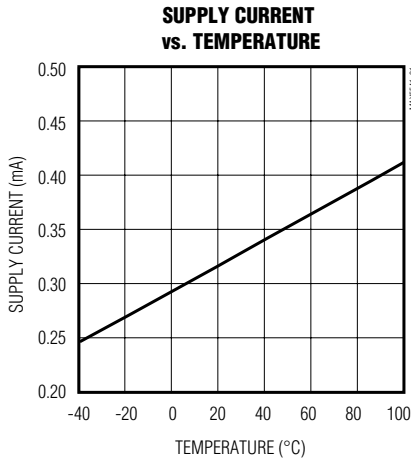

Low-Cost, +5V, Serial-Input, Voltage-Output, 16-Bit DAC

MAX5541

Typical Operating Characteristics (continued)

(VDD = +5V, VREF = +2.5V, TA = +25°C, unless otherwise noted.)

FULL-SCALE STEP RESPONSE
(fSCLK = 10MHz)

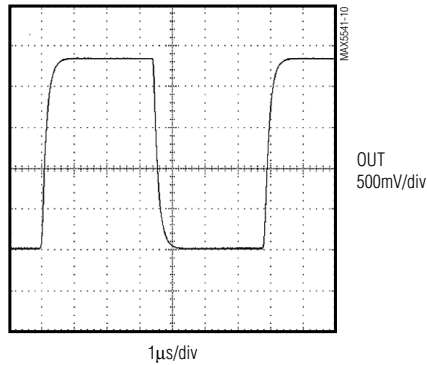

CL = 13pF, RL = ∞

FULL-SCALE STEP RESPONSE
(fSCLK = 20MHz)

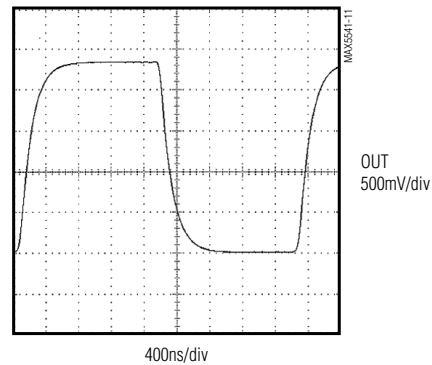

CL = 13pF, RL = ∞

MAJOR-CARRY OUTPUT GLITCH

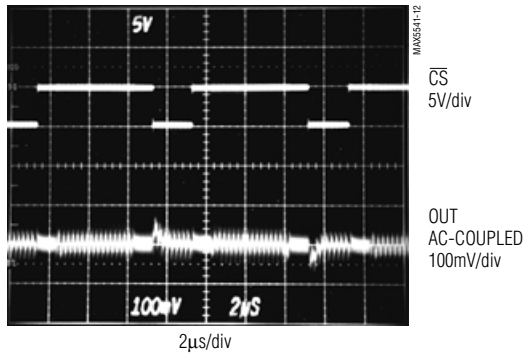

DIGITAL FEEDTHROUGH

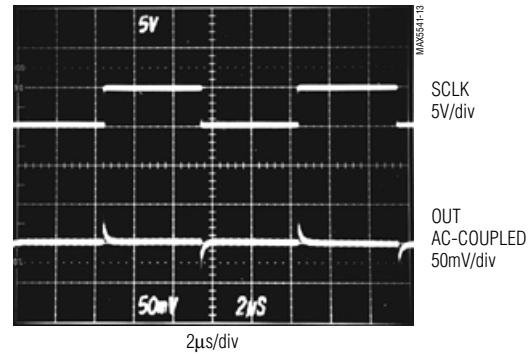

CODE = 0000 hex

Pin Description

PIN	NAME	FUNCTION
1	OUT	DAC Output Voltage
2	AGND	Analog Ground
3	REF	Voltage Reference Input. Connect to external +2.5V reference.
4	$\overline{\text{CS}}$	Chip-Select Input
5	SCLK	Serial-Clock Input. Duty cycle must be between 40% and 60%.
6	DIN	Serial-Data Input
7	DGND	Digital Ground
8	VDD	+5V Supply Voltage

Low-Cost, +5V, Serial-Input, Voltage-Output, 16-Bit DAC

Detailed Description

The MAX5541 voltage-output, 16-bit digital-to-analog converter (DAC) offers 16-bit monotonicity with less than 1LSB differential linearity error. Serial-data transfer minimizes the number of package pins required.

The MAX5541 is composed of two matched DAC sections, with a 12-bit inverted R-2R DAC forming the 12 LSBs and the 4 MSBs derived from 15 identically matched resistors. This architecture allows the lowest glitch energy to be transferred to the DAC output on major-carry transitions. It also decreases the DAC output impedance by a factor of eight compared to a standard R-2R ladder, allowing unbuffered operation in medium-load applications. Figure 1 is the Timing Diagram.

Digital Interface

The MAX5541 digital interface is a standard 3-wire connection compatible with SPI/QSPI/MICROWIRE interfaces. The chip-select input (\overline{CS}) frames the serial data loading at the data input pin (DIN). Immediately following \overline{CS} 's high-to-low transition, the data is shifted

synchronously and latched into the input register on the rising edge of the serial-clock input (SCLK). After 16 data bits have been loaded into the serial input register, it transfers its contents to the DAC latch on \overline{CS} 's low-to-high transition (Figure 2). Note that if \overline{CS} does not remain low during the entire 16 SCLK cycles, data will be corrupted. In this case, reload the DAC latch with a new 16-bit word.

External Reference

The MAX5541 operates with external voltage references from 2V to 3V. The reference voltage determines the DAC's full-scale output voltage.

Power-On Reset

The MAX5541 has a power-on reset circuit to set the DAC's output to 0V in unipolar mode when V_{DD} is first applied. This ensures that unwanted DAC output voltages will not occur immediately following a system power-up, such as after power loss. In bipolar mode, the DAC output is set to $-V_{REF}$.

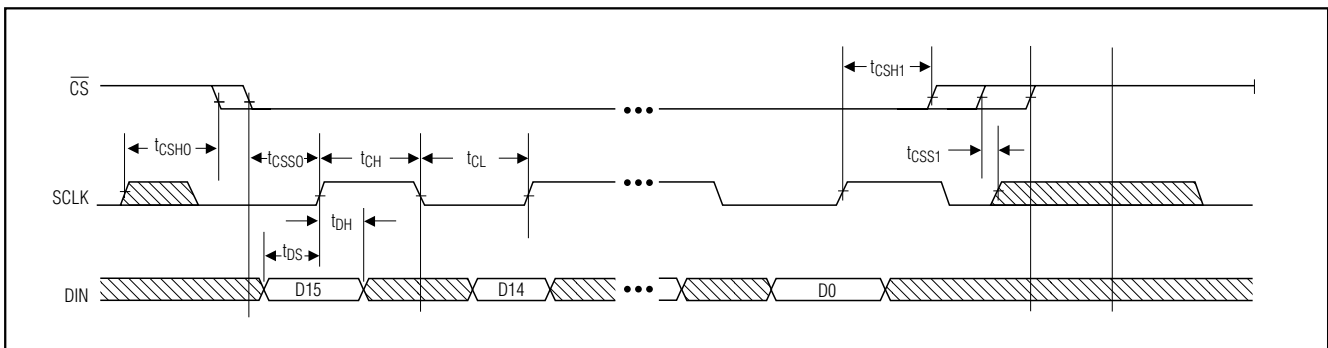

Figure 1. Timing Diagram

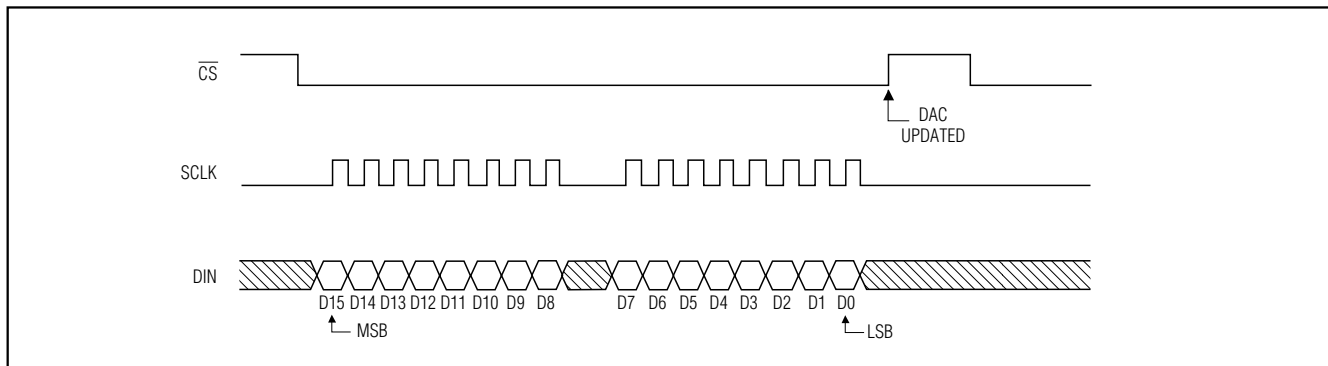

Figure 2. 3-Wire Interface Timing Diagram

Low-Cost, +5V, Serial-Input, Voltage-Output, 16-Bit DAC

MAX5541

Applications Information

Reference and Analog Ground Inputs

The MAX5541 operates with external voltage references from 2V to 3V, and maintains 16-bit performance with proper reference selection and application. Ideally, the reference's temperature coefficient should be less than 0.4ppm/°C to maintain 16-bit accuracy to within 1LSB over the commercial (0°C to +70°C) temperature range. Since this converter is designed as an inverted R-2R voltage-mode DAC, the input resistance seen by the voltage reference is code dependent. The worst-case input-resistance variation is from 11.5kΩ (at code 8555 hex) to 200kΩ (at code 0000 hex). The maximum change in load current for a 2.5V reference is $2.5V / 11.5k\Omega = 217\mu A$; therefore, the required load regulation is 7ppm/mA for a maximum error of 0.1LSB. This implies a reference output impedance of <18mΩ. In addition, the impedance of the signal path from the voltage reference to the reference input must be kept low because it contributes directly to the load-regulation error.

The requirement for a low-impedance voltage reference is met with capacitor bypassing at the reference inputs and ground. A 0.1μF ceramic capacitor with short leads between REF and AGND provides high-frequency bypassing. A surface-mount ceramic chip capacitor is preferred because it has the lowest inductance. An additional 10μF between REF and AGND provides low-frequency bypassing. A low-ESR tantalum, film, or organic semiconductor capacitor works well. Leaded capacitors are acceptable because impedance is not as critical at lower frequencies. The circuit can benefit from even larger bypassing capacitors, depending on the stability of the external reference with capacitive loading. If separate force and sense lines are not used, connect the appropriate force and sense pins together close to the package.

AGND must also be low impedance, as load-regulation errors will be introduced by excessive AGND resistance. As in all high-resolution, high-accuracy applications, separate analog and digital ground planes yield the best results. Connect DGND to AGND at the AGND pin to form the "star" ground for the DAC system. For the best possible performance, always refer remote DAC loads to this system ground.

Unbuffered Operation

Unbuffered operation reduces power consumption as well as offset error contributed by the external output buffer. The R-2R DAC output is available directly at OUT, allowing 16-bit performance from +VREF to AGND without degradation at zero-scale. The DAC's output impedance is also low enough to drive medium loads

($R_L > 60k\Omega$) without degradation of INL or DNL; only the gain error is increased by externally loading the DAC output.

External Output Buffer Amplifier

In unipolar mode, the output amplifier is used in a voltage-follower connection. The DAC's output resistance is constant and is independent of input code; however, the output amplifier's input impedance should still be as high as possible to minimize gain errors. The DAC's output capacitance is also independent of input code, thus simplifying stability requirements on the external amplifier.

In single-supply applications, precision amplifiers with input common-mode ranges including AGND are available; however, their output swings do not normally include the negative rail (AGND) without significant performance degradation. A single-supply op amp, such as the MAX495, is suitable if the application does not use codes near zero.

Since the LSBs for a 16-bit DAC are extremely small (38.15μV for $V_{REF} = 2.5V$), pay close attention to the external amplifier's input specification. The input offset voltage can degrade the zero-scale error and might require an output offset trim to maintain full accuracy if the offset voltage is greater than 1/2LSB. Similarly, the input bias current multiplied by the DAC output resistance (typically 6.25kΩ) contributes to the zero-scale error. Temperature effects also must be taken into consideration. Over the commercial temperature range, the offset voltage temperature coefficient (referenced to +25°C) must be less than 0.42μV/°C to add less than 1/2LSB of zero-scale error. The external amplifier's input resistance forms a resistive divider with the DAC output resistance, which results in a gain error. To contribute less than 1/2LSB of gain error, the input resistance typically must be greater than:

$$6.25k\Omega / \frac{1}{2} \left[\frac{1}{2^{14}} \right] = 205M\Omega$$

The settling time is affected by the buffer input capacitance, the DAC's output capacitance, and PC board capacitance. The typical DAC output voltage settling time is 1μs for a full-scale step. Settling time can be significantly less for smaller step changes. Assuming a single time-constant exponential settling response, a full-scale step takes 12 time constants to settle to within 1/2LSB of the final output voltage. The time constant is equal to the DAC output resistance multiplied by the total output capacitance. The DAC output capacitance is typically 10pF. Any additional output capacitance will increase the settling time.

Low-Cost, +5V, Serial-Input, Voltage-Output, 16-Bit DAC

The external buffer amplifier's gain-bandwidth product is important because it increases the settling time by adding another time constant to the output response. The effective time constant of two cascaded systems, each with a single time-constant response, is approximately the root square sum of the two time constants. The DAC output's time constant is $1\mu\text{s} / 12 = 83\text{ns}$, ignoring the effect of additional capacitance. If the time constant of an external amplifier with 1MHz bandwidth is $1 / 2\pi (1\text{MHz}) = 159\text{ns}$, then the effective time constant of the combined system is:

$$\sqrt{(96\text{ns})^2 + (159\text{ns})^2} = 186\text{ns}$$

This suggests that the settling time to within 1/2LSB of the final output voltage, including the external buffer amplifier, will be approximately $12 \cdot 180\text{ns} = 2.15\mu\text{s}$.

Digital Inputs and Interface Logic

The digital interface for the 16-bit DAC is based on a 3-wire standard that is SPI/QSPI/MICROWIRE compatible. The three digital inputs ($\overline{\text{CS}}$, DIN, and SCLK) load the digital input data serially into the DAC.

All of the digital inputs include Schmitt-trigger buffers to accept slow-transition interfaces. This means that optocouplers can interface directly to the MAX5541 without additional external logic. The digital inputs are TTL/CMOS-logic compatible.

Unipolar Configuration

Figure 3 shows the MAX5541 configured for unipolar operation with an external op amp. The op amp is set for unity gain, and Table 1 shows the codes for this circuit.

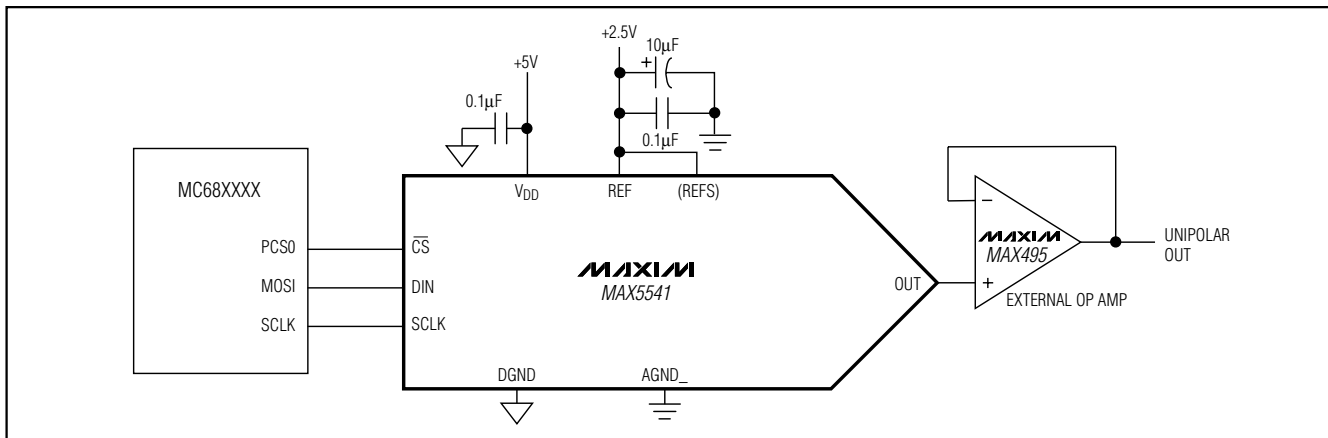

Figure 3. Typical Operating Circuit

Maxim cannot assume responsibility for use of any circuitry other than circuitry entirely embodied in a Maxim product. No circuit patent licenses are implied. Maxim reserves the right to change the circuitry and specifications without notice at any time.

8 Maxim Integrated Products, 120 San Gabriel Drive, Sunnyvale, CA 94086 408-737-7600

Table 1. Unipolar Code Table

DAC LATCH CONTENTS		ANALOG OUTPUT, V_{OUT}
MSB	LSB	
1111 1111 1111 1111		$V_{\text{REF}} \cdot (65,535 / 65,536)$
1000 0000 0000 0000		$V_{\text{REF}} \cdot (32,768 / 65,536) = 1/2 V_{\text{REF}}$
0000 0000 0000 0001		$V_{\text{REF}} \cdot (1 / 65,536)$
0000 0000 0000 0000		0V

Power-Supply Bypassing and Ground Management

For optimum system performance, use PC boards with separate analog and digital ground planes. Wire-wrap boards are not recommended. Connect the two ground planes together at the low-impedance power-supply source. Connect DGND and AGND together at the IC. The best ground connection can be achieved by connecting the DAC's DGND and AGND pins together and connecting that point to the system analog ground plane. If the DAC's DGND is connected to the system digital ground, digital noise may get through to the DAC's analog portion.

Bypass V_{DD} with a 0.1µF ceramic capacitor connected between V_{DD} and AGND. Mount it with short leads close to the device. Ferrite beads can also be used to further isolate the analog and digital power supplies.

Chip Information

TRANSISTOR COUNT: 2209

SUBSTRATE CONNECTED TO DGND