

KSS Series Subminiature Side Actuated Tact Switch for SMT



Features/Benefits

- Low profile of 1.6 mm
- Excellent tactile feel
- High shear force
- Range of actuation forces
- Large flat top
- Redundant contacts option
- Date code marking

Typical Applications

- Cellular phone
- PDA, pagers
- Industrial electronics
- Health diagnostic electronics

B
Tactile Switches

Specification

FUNCTION: momentary action
CONTACT ARRANGEMENT: N.O.
TERMINALS: Gullwing & 3-Way type for SMT

Mechanical

| Type | Operating force Newtons (grams) | Operating life (operations) | Travel |
|---------|------------------------------------|--------------------------------|------------|
| KSS221G | 2.0 (200) ± 25% | 100,000 | 0,3 ± 0,15 |
| KSS231G | 2.5 (250) ± 20% | 100,000 | 0,3 ± 0,10 |
| KSS233W | 2.5 (200) ± 25% | 100,000 | 0,3 ± 0,15 |
| KSS241G | 4.0 (400) ± 25% | 100,000 | 0,3 ± 0,15 |

Electrical

| | | |
|------------------|--------|--------|
| | Silver | Gold |
| MAXIMUM POWER: | 1 VA | 0.2 VA |
| MAXIMUM VOLTAGE: | 50 VDC | 50 VDC |
| MAXIMUM CURRENT: | 50 mA | 10 mA |
| MINIMUM CURRENT: | 1 mA | 1 mA |

DIELECTRIC STRENGTH: ≥ 250 VDC
CONTACT RESISTANCE: ≤ 100 mΩ
INSULATION RESISTANCE (100 VDC): ≥ 10⁹ Ω
BOUNCE TIME: ≤ 3 ms

Environmental

| | | |
|------------------------|---------------|----------------|
| | Silver | Gold |
| OPERATING TEMPERATURE: | -40°C to 85°C | -40°C to 125°C |
| STORAGE TEMPERATURE: | -55°C to 85°C | -55°C to 125°C |

Process

SOLDERING: Infrared reflow in accordance with CECC00802

Packaging

Switches are delivered in tape and reels of 3,000 pieces. The reel diameter is 330mm (12.992 x .15). The tape dimensions conform to the EIA-RS-481 and CE-2863 norms.

NOTE: Part numbers listed above do not represent all possible configurations. For information on specific and custom switches, consult Customer Service Center.

How To Order

Our easy build-a-switch concept allows you to mix and match options to create the switch you need. To order, select desired option from each category and place it in the appropriate box.

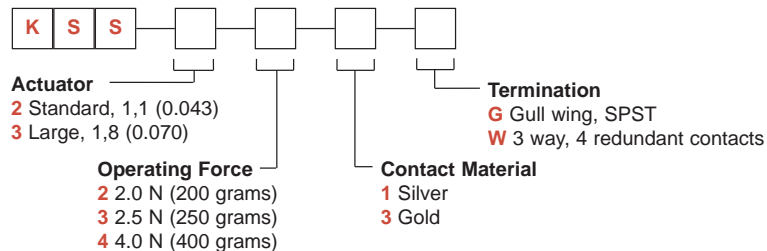

KSS Series Subminiature Side Actuated Tact Switch for SMT

SERIES

KSS



KSS221G

Each piece is date code printed:
1st Line: 9308 = Year 1999, 308 day in the year
2nd Line: 221XA = Manufacturing code.

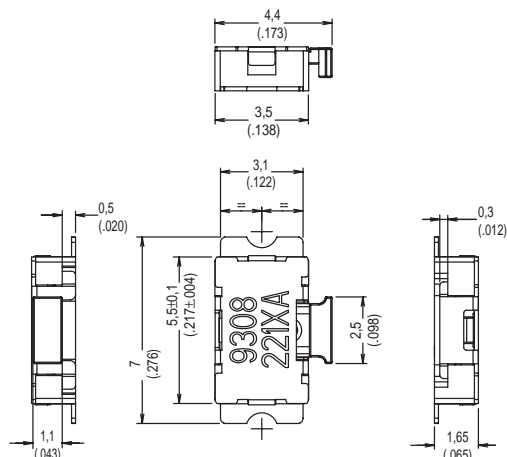

ACTUATOR

2 STANDARD, 1,1 (0.043)

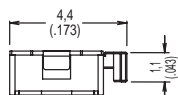

3 LARGE, 1,8 (0.070)

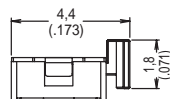

OPERATING FORCE

| OPTION CODE | OPERATING FORCE |
|-------------|-------------------|
| 2 | 2.0 N (200 grams) |
| 3 | 2.5 N (250 grams) |
| 4 | 4.0 N (400 grams) |

CONTACT MATERIAL

| OPTION CODE | MATERIAL |
|-------------|----------|
| 1 | SILVER |
| 3 | GOLD |

TERMINATION

G GULLWING

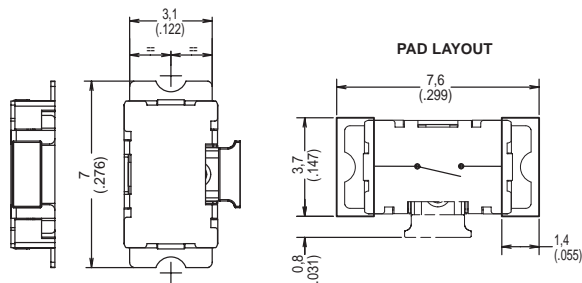

W 3 WAY, 4 REDUNDANT CONTACTS

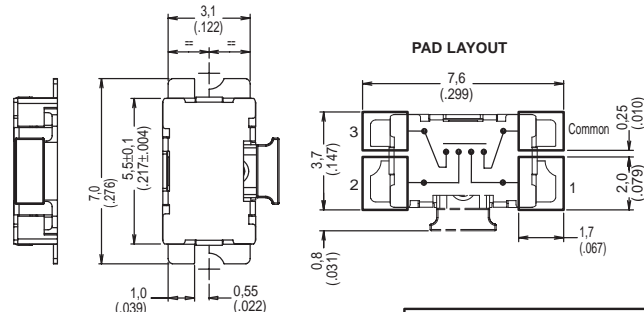

KSS Series Subminiature Side Actuated Tact Switch for SMT

TAPE & REEL

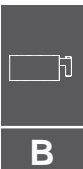
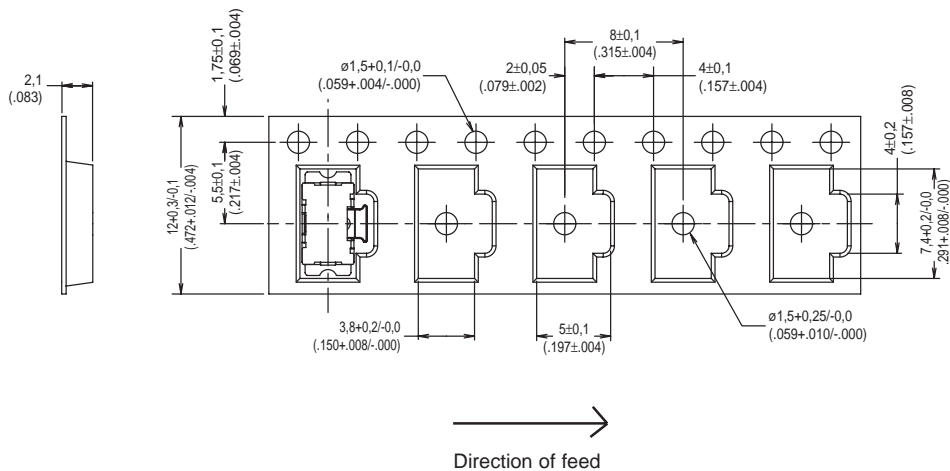

B

Tactile Switches