

**MOC3040, MOC3041, MOC3042, MOC3043  
MOC3040X, MOC3041X, MOC3042X, MOC3043X**



**OPTICALLY COUPLED BILATERAL  
SWITCH LIGHT ACTIVATED ZERO  
VOLTAGE CROSSING TRIAC**

**'X' SPECIFICATION APPROVALS**

- VDE 0884 in 3 available lead form :-  
- STD  
- G form  
- SMD approved to CECC 00802

**DESCRIPTION**

The MOC304\_ Series are optically coupled isolators consisting of a Gallium Arsenide infrared emitting diode coupled with a monolithic silicon detector performing the functions of a zero crossing bilateral triac mounted in a standard 6 pin dual-in-line package.

**FEATURES**

- Options :-  
10mm lead spread - add G after part no.  
Surface mount - add SM after part no.  
Tape&reel - add SMT&R after part no.
- High Isolation Voltage (5.3kV<sub>RMS</sub>, 7.5kV<sub>PK</sub>)
- Zero Voltage Crossing
- 400V Peak Blocking Voltage
- All electrical parameters 100% tested
- Custom electrical selections available

**APPLICATIONS**

- CRTs
- Power Triac Driver
- Motors
- Consumer appliances
- Printers

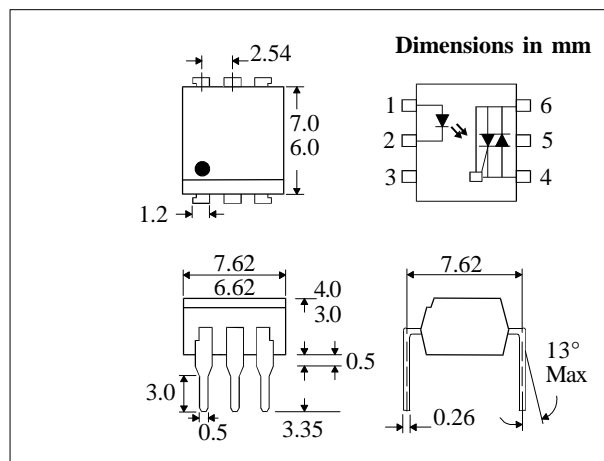

**ABSOLUTE MAXIMUM RATINGS  
(25 °C unless otherwise noted)**

Storage Temperature	-55°C - +150°C
Operating Temperature	-40°C - +100°C
Lead Soldering Temperature	260°C (1.6mm from case for 10 seconds)

**INPUT DIODE**

Forward Current	50mA
Reverse Voltage	6V
Power Dissipation	120mW (derate linearly 1.41mW/°C above 25°C)

**OUTPUT PHOTO TRIAC**

Off-State Output Terminal Voltage	400V
Forward Current (Peak)	1A
Power Dissipation	150mW (derate linearly 1.76mW/°C above 25°C)

**POWER DISSIPATION**

Total Power Dissipation	250mW (derate linearly 2.94mW/°C above 25°C)
-------------------------	---

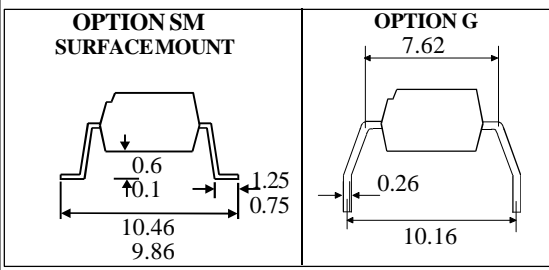

**ISOCOM COMPONENTS LTD**  
Unit 25B, Park View Road West,  
Park View Industrial Estate, Brenda Road  
Hartlepool, TS25 1YD England Tel: (01429)863609  
Fax: (01429) 863581 e-mail sales@isocom.co.uk  
<http://www.isocom.com>

**ISOCOM INC**  
1024 S. Greenville Ave, Suite 240,  
Allen, TX 75002 USA  
Tel: (214)495-0755 Fax: (214)495-0901  
e-mail info@isocom.com  
<http://www.isocom.com>

**ELECTRICAL CHARACTERISTICS (  $T_A = 25^\circ\text{C}$  Unless otherwise noted )**

PARAMETER		MIN	TYP	MAX	UNITS	TEST CONDITION
Input	Forward Voltage ( $V_F$ ) Reverse Current ( $I_R$ )		1.2	1.4 10	V $\mu\text{A}$	$I_F = 20\text{mA}$ $V_R = 6\text{V}$
Output	Peak Off-state Current ( $I_{\text{DRM}}$ ) Peak Blocking Voltage ( $V_{\text{DRM}}$ ) On-state Voltage ( $V_{\text{TM}}$ )  Critical rate of rise of off-state Voltage ( $dv/dt$ )	400		500  3.0	nA V V	$V_{\text{DRM}} = 400\text{V}$ (note 1) $I_{\text{DRM}} = 500\text{nA}$ $I_{\text{TM}} = 100\text{mA}$ ( peak )
Coupled	Input Current to Trigger ( $I_{\text{FT}}$ )(note 2) MOC3040 MOC3041 MOC3042 MOC3043  Holding Current , either direction ( $I_H$ ) Input to Output Isolation Voltage $V_{\text{ISO}}$			30 15 10 5	mA mA mA mA	$V_{\text{TM}} = 3\text{V}$ ( note 2 )
		5300 7500	400		$\mu\text{A}$ $V_{\text{RMS}}$ $V_{\text{PK}}$	See note 3 See note 3
Zero Crossing Charact- -eristic	Inhibit Voltage ( $V_{\text{IH}}$ )  Leakage in Inhibited State ( $I_S$ )			20  500	V  mA	$I_F = \text{Rated } I_{\text{FT}}$ MT1-MT2 Voltage above which device will not trigger $I_F = \text{Rated } I_{\text{FT}}$ $V_{\text{DRM}} = \text{Rated } V_{\text{DRM}}$ Off-state

Note 1. Test voltage must be applied within  $dv/dt$  rating.

Note 2. Guaranteed to trigger at an  $I_F$  value less than or equal to max.  $I_{\text{FT}}$ , recommended  $I_F$  lies between Rated  $I_{\text{FT}}$  and absolute max.  $I_F$ .

Note 3. Measured with input leads shorted together and output leads shorted together.

## CHARACTERISTIC CURVES

Fig.1 Forward Current vs. Ambient Temperature

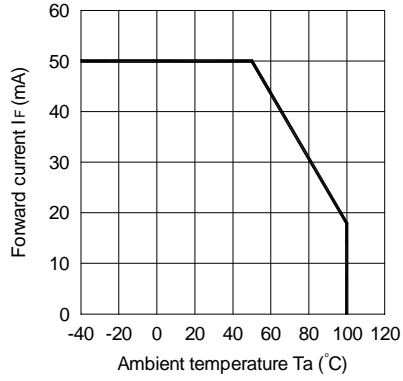

Fig.2 On-state Current vs. Ambient Temperature

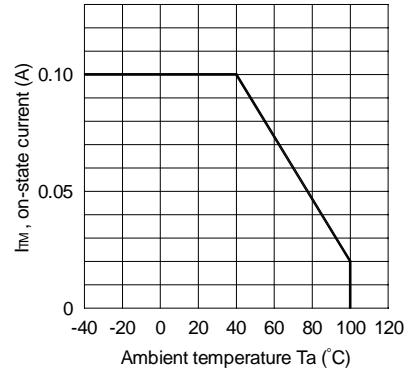

Fig.3 Minimum Trigger Current vs. Ambient Temperature

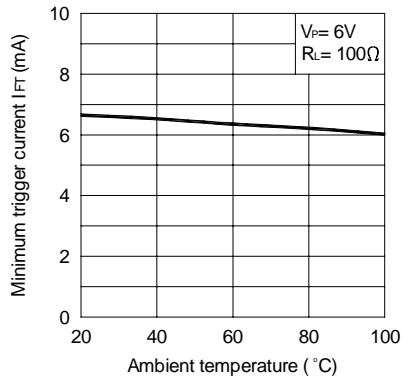

Fig.4 Forward Current vs. Forward Voltage

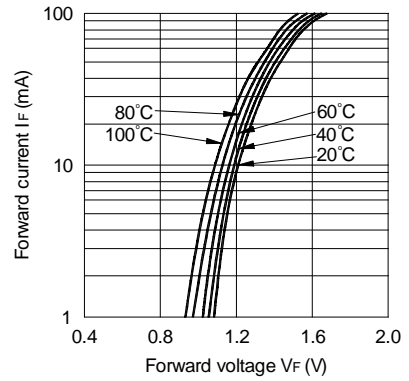

Fig.5 On-state Voltage vs. Ambient Temperature

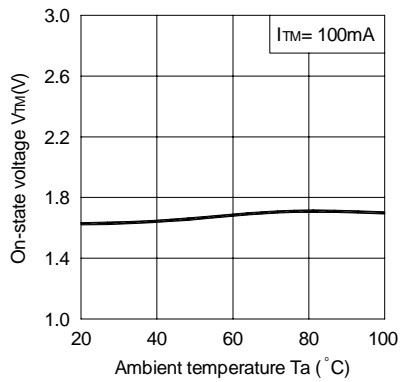
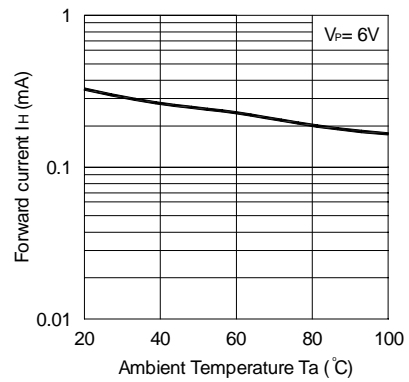

Fig.6 Holding Current vs. Ambient Temperature



## CHARACTERISTIC CURVES

Fig.7 Turn-on Time vs. Forward Current

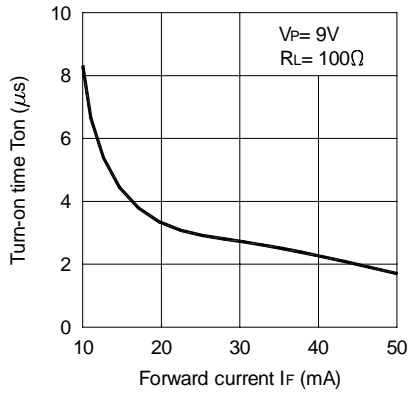

Fig.8 Repetitive Peak Off-state Current vs. Temperature

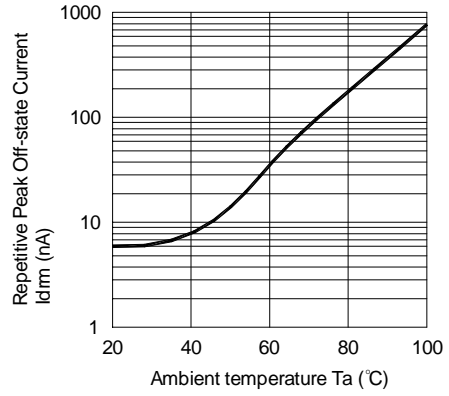
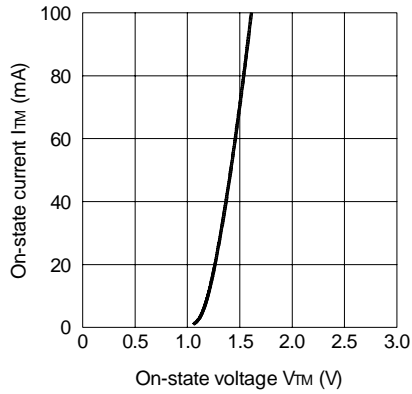

Fig.9 On-state Current vs. On-state Voltage



Static dv/dt Test Circuit

