

# HFA32PA120C

HEXFRED™

Ultrafast, Soft Recovery Diode

## Features

- Ultrafast Recovery
- Ultrasoft Recovery
- Very Low  $I_{RRM}$
- Very Low  $Q_{rr}$
- Specified at Operating Conditions

## Benefits

- Reduced RFI and EMI
- Reduced Power Loss in Diode and Switching Transistor
- Higher Frequency Operation
- Reduced Snubbing
- Reduced Parts Count

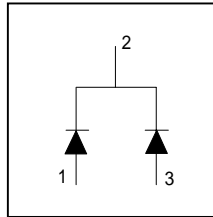

| per Leg          |         |
|------------------|---------|
| $V_R$            | = 1200V |
| $V_F$ (typ.)     | = 2.3V  |
| $I_{F(AV)}$      | = 16A   |
| $Q_{rr}$ (typ.)  | = 260nC |
| $I_{RRM}$ (typ.) | = 5.8A  |
| $t_{rr}$ (typ.)  | = 30ns  |

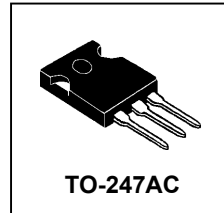

## Description

International Rectifier's HFA32PA120C is a state of the art ultra fast recovery diode. Employing the latest in epitaxial construction and advanced processing techniques it features a superb combination of characteristics which result in performance which is unsurpassed by any rectifier previously available. With basic ratings of 1200 volts and 16 amps continuous current, the HFA32PA120C is especially well suited for use as the companion diode for IGBTs and MOSFETs. In addition to ultra fast recovery time, the HEXFRED product line features extremely low values of peak recovery current ( $I_{RRM}$ ) and does not exhibit any tendency to "snap-off" during the  $t_b$  portion of recovery. The HEXFRED features combine to offer designers a rectifier with lower noise and significantly lower switching losses in both the diode and the switching transistor. These HEXFRED advantages can help to significantly reduce snubbing, component count and heatsink sizes. The HEXFRED HFA32PA120C is ideally suited for applications in power supplies and power conversion systems (such as inverters), motor drives, and many other similar applications where high speed, high efficiency is needed.

## Absolute Maximum Ratings (per Leg)

|                                 | Parameter                          | Max         | Units |
|---------------------------------|------------------------------------|-------------|-------|
| $V_R$                           | Cathode-to-Anode Voltage           | 1200        | V     |
| $I_F @ T_C = 100^\circ\text{C}$ | Continuous Forward Current         | 16          | A     |
| $I_{FSM}$                       | Single Pulse Forward Current       | 190         |       |
| $I_{FRM}$                       | Maximum Repetitive Forward Current | 64          | °C    |
| $P_D @ T_C = 25^\circ\text{C}$  | Maximum Power Dissipation          | 151         |       |
| $P_D @ T_C = 100^\circ\text{C}$ | Maximum Power Dissipation          | 60          | W     |
| $T_J$                           | Operating Junction and             | -55 to +150 |       |
| $T_{STG}$                       | Storage Temperature Range          |             |       |

\* 125°C

**Electrical Characteristics (per Leg) @ T<sub>J</sub> = 25°C (unless otherwise specified)**

|                 | Parameter                       | Min  | Typ  | Max  | Units | Test Conditions   |
|-----------------|---------------------------------|------|------|------|-------|---|
| V <sub>BR</sub> | Cathode Anode Breakdown Voltage | 1200 |      |      | V     | I <sub>R</sub> = 100μA  |
| V <sub>FM</sub> | Max Forward Voltage             |      | 2.5  | 3.0  | V     | I <sub>F</sub> = 16A  |
|                 |                                 |      | 3.2  | 3.93 |       | I <sub>F</sub> = 32A  |
|                 |                                 |      | 2.3  | 2.7  |       | I <sub>F</sub> = 16A, T <sub>J</sub> = 125°C                        |
| I <sub>RM</sub> | Max Reverse Leakage Current     |      | 0.75 | 20   | μA    | V <sub>R</sub> = V <sub>R</sub> Rated                               |
|                 |                                 |      | 375  | 2000 |       | T <sub>J</sub> = 125°C, V <sub>R</sub> = 0.8 x V <sub>R</sub> Rated |
| C <sub>T</sub>  | Junction Capacitance            |      | 27   | 40   | pF    | V <sub>R</sub> = 200V   |
| L <sub>S</sub>  | Series Inductance               |      | 8.0  |      | nH    | Measured lead to lead 5mm from package body                         |

**Dynamic Recovery Characteristics (per Leg) @ T<sub>J</sub> = 25°C (unless otherwise specified)**

|                           | Parameter                             | Min | Typ | Max  | Units | Test Conditions   |                        |
|---------------------------|---------------------------------------|-----|-----|------|-------|---|------------------------|
| t <sub>rr</sub>           | Reverse Recovery Time                 |     | 30  |      | ns    | I <sub>F</sub> = 1.0A, di/dt = 200A/μs, V <sub>R</sub> = 30V<br>T <sub>J</sub> = 25°C |                        |
| t <sub>rr1</sub>          | See Fig. 5, 10                        |     | 90  | 135  |       |   | I <sub>F</sub> = 16A   |
| t <sub>rr2</sub>          |                                       |     | 164 | 245  |       |   |                        |
| I <sub>RRM1</sub>         | Peak Recovery Current                 |     | 5.8 | 10   | A     | V <sub>R</sub> = 200V   |                        |
| I <sub>RRM2</sub>         | See Fig. 6                            |     | 8.3 | 15   |       |   | T <sub>J</sub> = 125°C |
| Q <sub>rr1</sub>          | Reverse Recovery Charge               |     | 260 | 675  | nC    | di/dt = 200A/μs   |                        |
| Q <sub>rr2</sub>          | See Fig. 7                            |     | 680 | 1838 |       |   | T <sub>J</sub> = 125°C |
| d <sub>i(rec)M</sub> /dt1 | Peak Rate of Fall of Recovery Current |     | 120 |      |       |   | T <sub>J</sub> = 25°C  |
| d <sub>i(rec)M</sub> /dt2 | During t <sub>b</sub> See Fig. 8      |     | 76  |      | A/μs  | T <sub>J</sub> = 125°C  |                        |

**Thermal - Mechanical Characteristics**

|                     | Parameter                               | Min | Typ  | Max  | Units  |
|---------------------|---|-----|------|------|--------|
| T <sub>lead</sub> ① | Lead Temperature                        |     |      | 300  | °C     |
| R <sub>thJC</sub>   | Thermal Resistance, Junction to Case    |     |      | 0.83 | K/W    |
| R <sub>thJA</sub> ② | Thermal Resistance, Junction to Ambient |     |      | 80   |        |
| R <sub>thCS</sub> ③ | Thermal Resistance, Case to Heat Sink   |     | 0.50 |      |        |
| Wt                  | Weight                                  |     | 2.0  |      | g      |
|                     |   |     | 0.07 |      | (oz)   |
|                     | Mounting Torque                         |     | 6.0  | 12   | Kg-cm  |
|                     |   |     | 5.0  | 10   | lbf-in |

① 0.063 in. from Case (1.6mm) for 10 sec

② Typical Socket Mount

③ Mounting Surface, Flat, Smooth and Greased

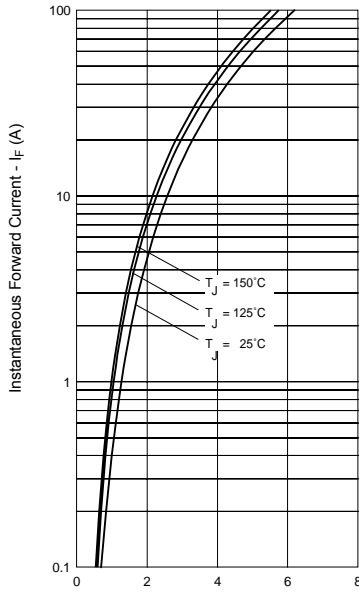

**Fig. 1 - Maximum Forward Voltage Drop vs. Instantaneous Forward Current**

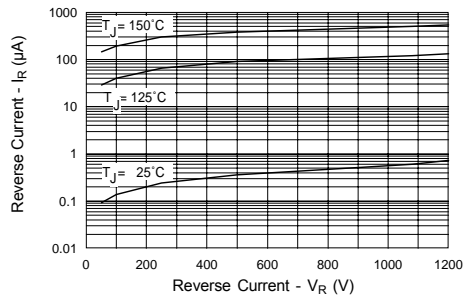

**Fig. 2 - Typical Reverse Current vs. Reverse Voltage**

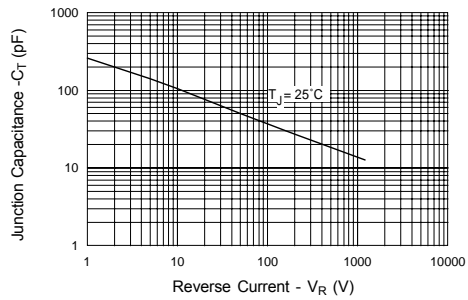

**Fig. 3 - Typical Junction Capacitance vs. Reverse Voltage**

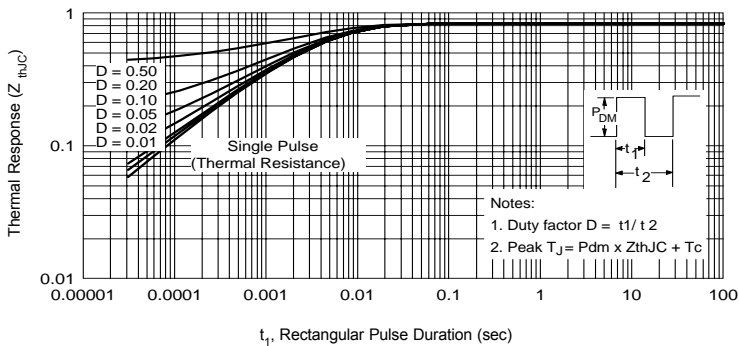

**Fig. 4 - Maximum Thermal Impedance  $Z_{th(jc)}$  Characteristics**

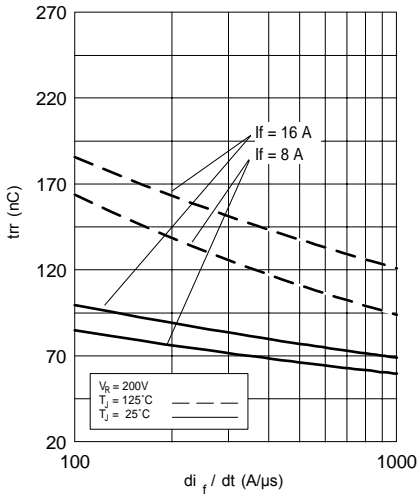

**Fig. 5 - Typical Reverse Recovery vs.  $di_f/dt$ , (per Leg)**

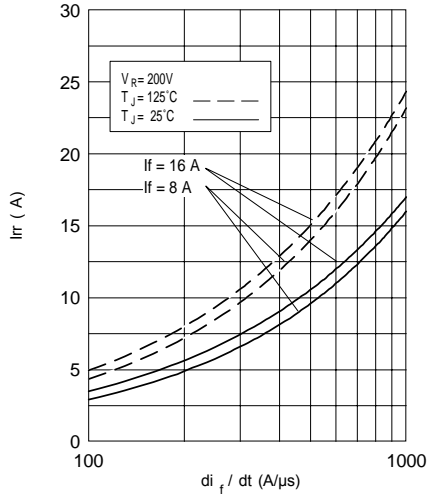

**Fig. 6 - Typical Recovery Current vs.  $di_f/dt$ , (per Leg)**

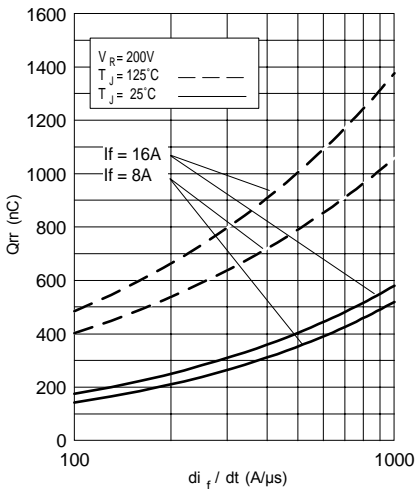

**Fig. 7 - Typical Stored Charge vs.  $di_f/dt$ , (per Leg)**

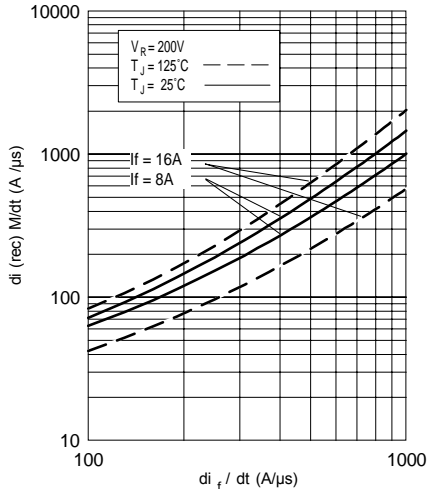

**Fig. 8 - Typical  $di_{(rec)}M/dt$  vs.  $di_f/dt$ , (per Leg)**

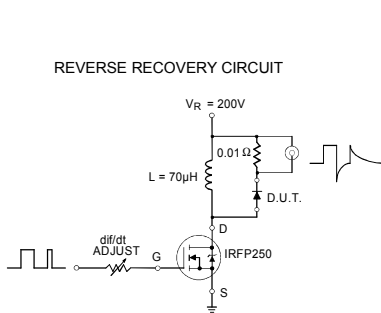

**Fig. 9 - Reverse Recovery Parameter Test Circuit**

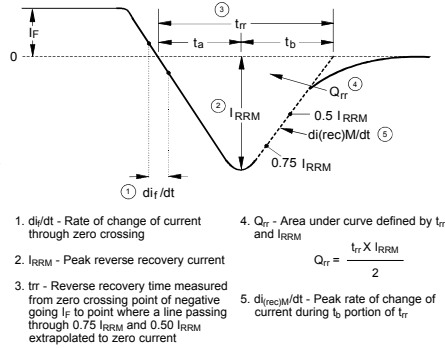
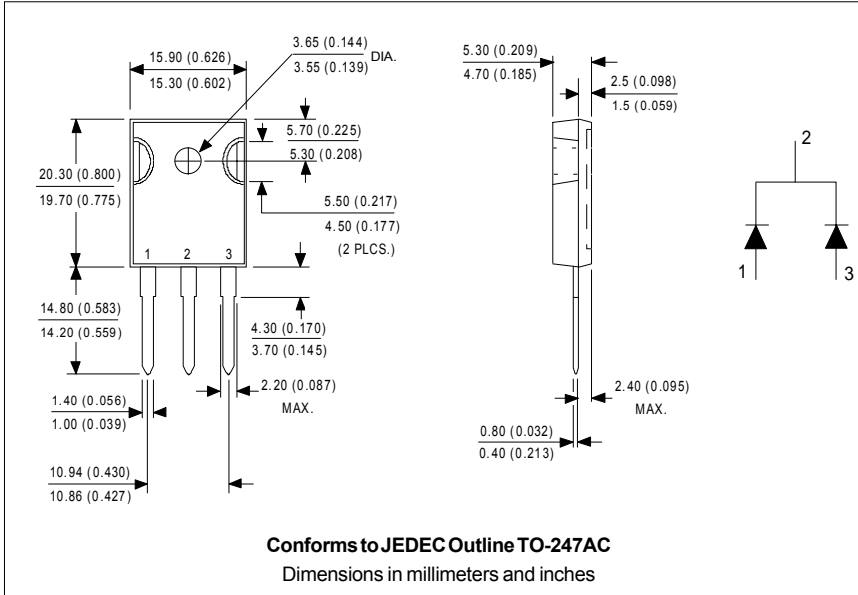

**Fig. 10 - Reverse Recovery Waveform and Definitions**

**Ordering Information Table**

| Device Code |   |           |           |            |          |
|-------------|---|-----------|-----------|------------|----------|
| <b>HF</b>   | <b>A</b>  | <b>32</b> | <b>PA</b> | <b>120</b> | <b>C</b> |
| ①           | ②   | ③         | ④         | ⑤          | ⑥        |
| <b>1</b>    | - Hexfred Family  |           |           |            |          |
| <b>2</b>    | - Process Designator    A = subs. elec. irradi.<br>B = subs. Platinum |           |           |            |          |
| <b>3</b>    | - Current Rating            (32 = 32A)                                |           |           |            |          |
| <b>4</b>    | - Package Outline        (PA = TO-247, 3 pins)                        |           |           |            |          |
| <b>5</b>    | - Voltage Rating         (120 = 1200V)                                |           |           |            |          |
| <b>6</b>    | - Configuration            (C = Center Tap Common Cathode)            |           |           |            |          |

**Outline Table**



Data and specifications subject to change without notice.  
 This product has been designed and qualified for Industrial Level.  
 Qualification Standards can be found on IR's Web site.