

Off-line SMPS Controller with 600 V Sense CoolMOS on Board

TDA16831-4

Preliminary Data

CoolSET

Overview

Features

- PWM controller + sense CoolMOS attached in one compact package
- 600 V avalanche rugged CoolMOS
- Typical $R_{DSon} = 0.5 \dots 3.5 \Omega$ at $T_j = 25 \text{ }^\circ\text{C}$
- Only 4 active Pins
- Standard DIP-8 Package for Output Power $\leq 40 \text{ W}$
- Only few external components required
- Low start up current
- Current mode control
- Input Undervoltage Lockout
- Max. Duty Cycle limitation
- Thermal Shutdown
- Modulated Gate Drive for low EMI

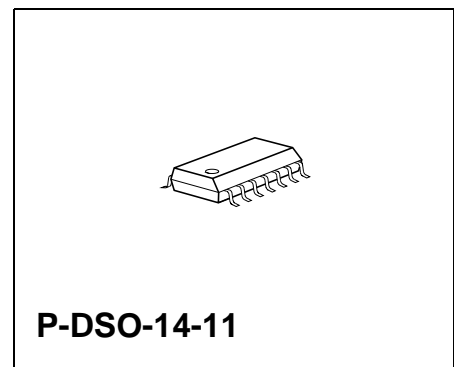
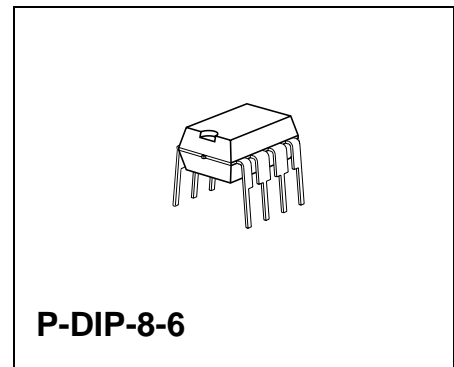

Type	Ordering Code	Package
TDA 16831	Q67000-A9420	P-DIP-8-6
TDA 16832	Q67000-A9422	P-DIP-8-6
TDA 16833	Q67000-A9389	P-DIP-8-6
TDA 16834	samples	P-DIP-8-6
TDA 16831G	Q67000-A9421	P-DSO-14-11
TDA 16832G	Q67000-A9423	P-DSO-14-11
TDA 16833G	Q67000-A9419	P-DSO-14-11

Device	Output Power Range/ Required Heatsink¹⁾	Output Power Range/ Required Heatsink¹⁾
	$V_{in} = 85-270 \text{ VAC}$	$V_{in} = 190-265 \text{ VAC}$
TDA 16831	10 W / no heatsink	10 W / no heatsink
TDA 16832	20 W / 6 cm ²	20 W / no heatsink
TDA 16833	30 W / 3 cm ²	40 W / no heatsink
TDA 16834	40 W / 3 cm ²	40 W / no heatsink
TDA 16831G	10 W / no heatsink	10 W / no heatsink
TDA 16832G	20 W / 8 cm ²	20 W / no heatsink
TDA 16833G	20 W / no heatsink	40 W / 3 cm ²

¹⁾ $T_A = 70 \text{ }^\circ\text{C}$

Pin Configurations

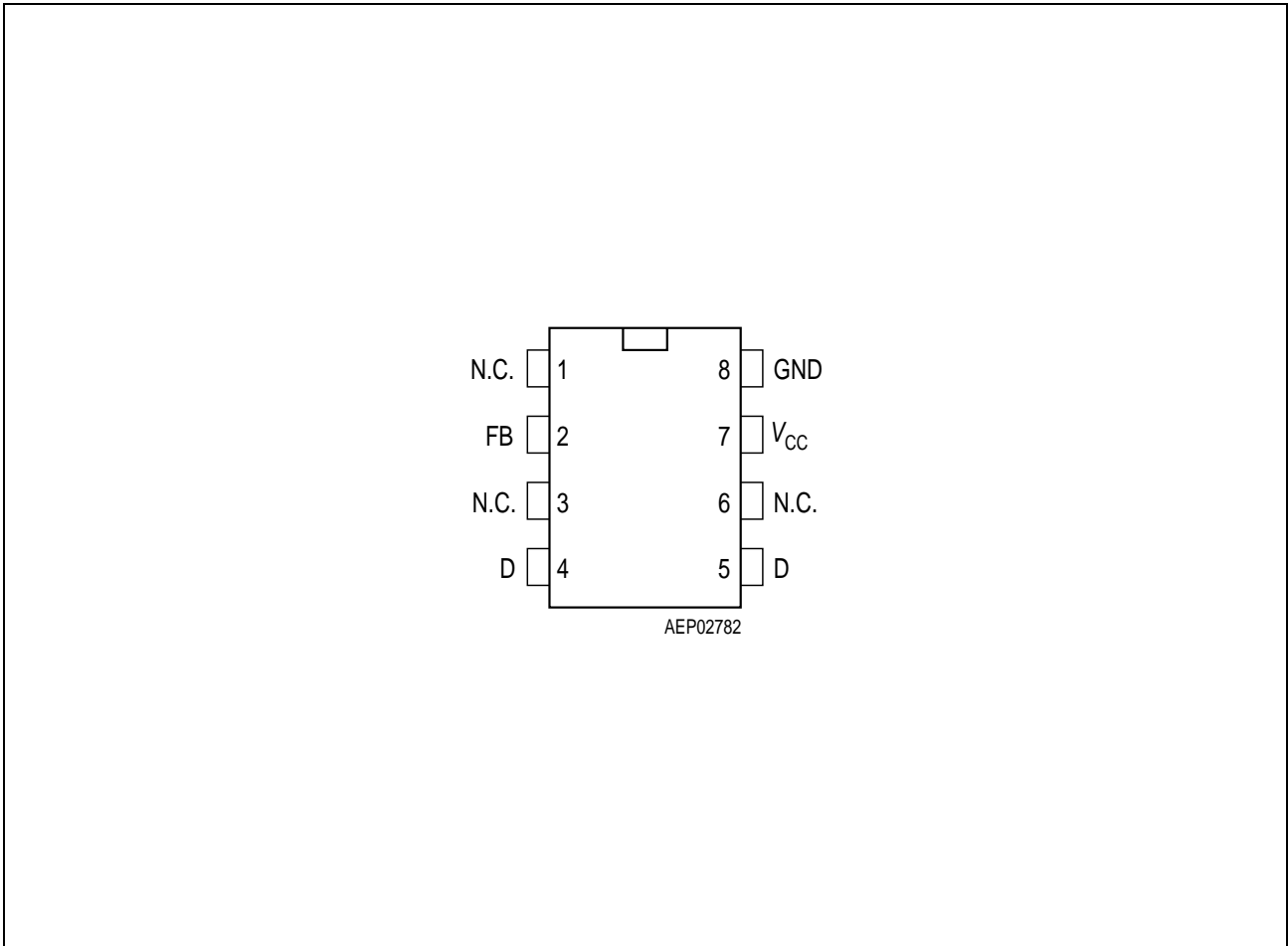

Figure 1 TDA 16831/2/3/4

P-DIP-8-6 for Applications with $P_{out} \leq 40\text{ W}$: TDA 16831/2/3/4

Pin	Symbol	Function
1	N.C.	Not Connected
2	FB	PWM Feedback Input
3	N.C.	Not Connected
4	D	600 V Drain CoolMOS
5	D	600 V Drain CoolMOS
6	N.C.	Not Connected
7	V_{CC}	PWM Supply Voltage
8	GND	PWM GND and Source of CoolMOS

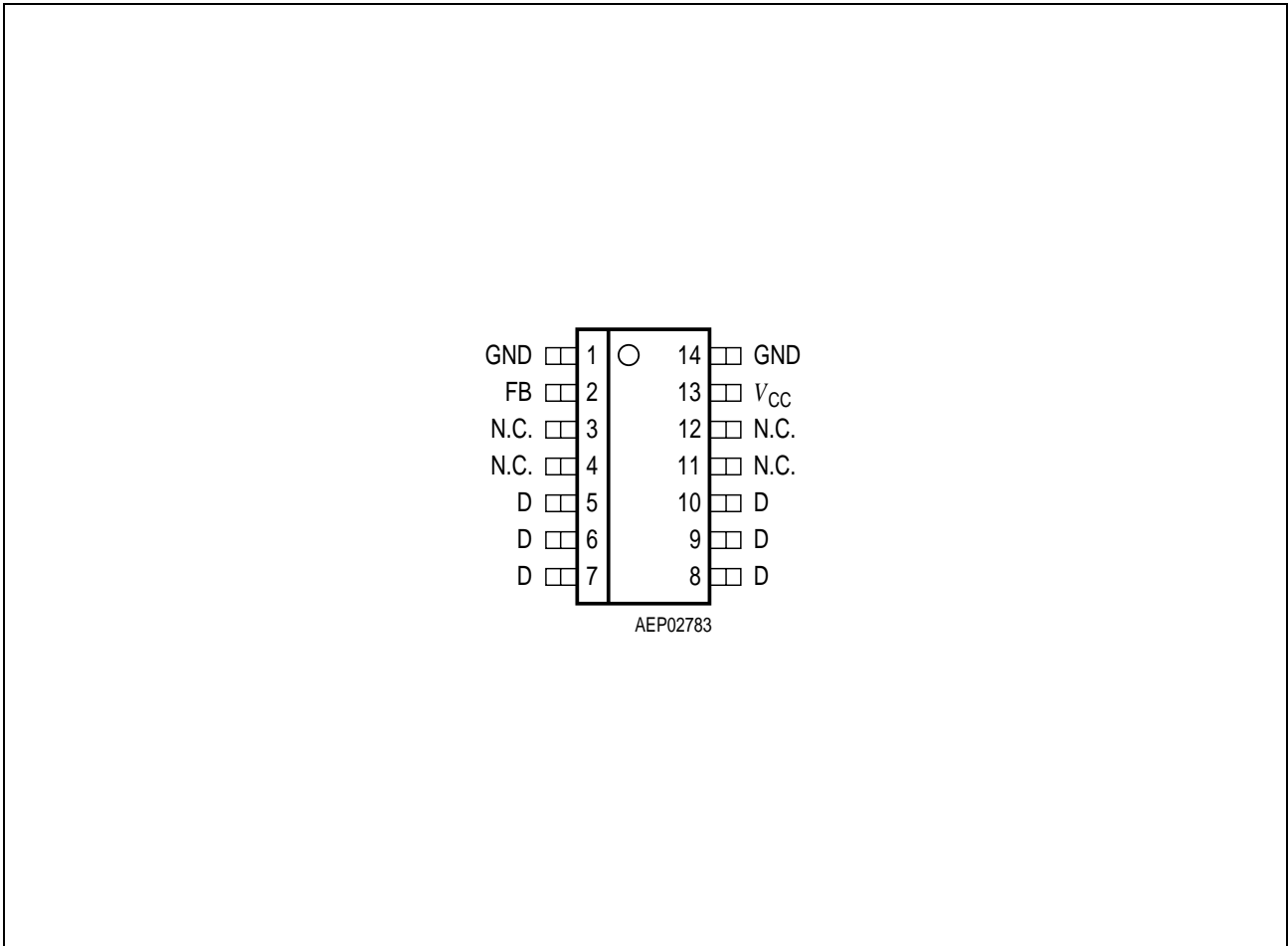

Figure 2 TDA 16831G/2G/3G

P-DSO-14-11 for Applications with $P_{out} \leq 20$ W: TDA 16831G/2G/3G

Pin	Symbol	Function
1	GND	PWM GND and CoolMOS Source
2	FB	PWM Feedback Input
3	N.C.	Not Connected
4	N.C.	Not Connected
5, 6, 7	D	600 V Drain CoolMOS
8, 9, 10	D	600 V Drain CoolMOS
11	N.C.	Not Connected
12	N.C.	Not Connected
13	V_{CC}	PWM Supply Voltage
14	GND	PWM GND and Source of CoolMOS

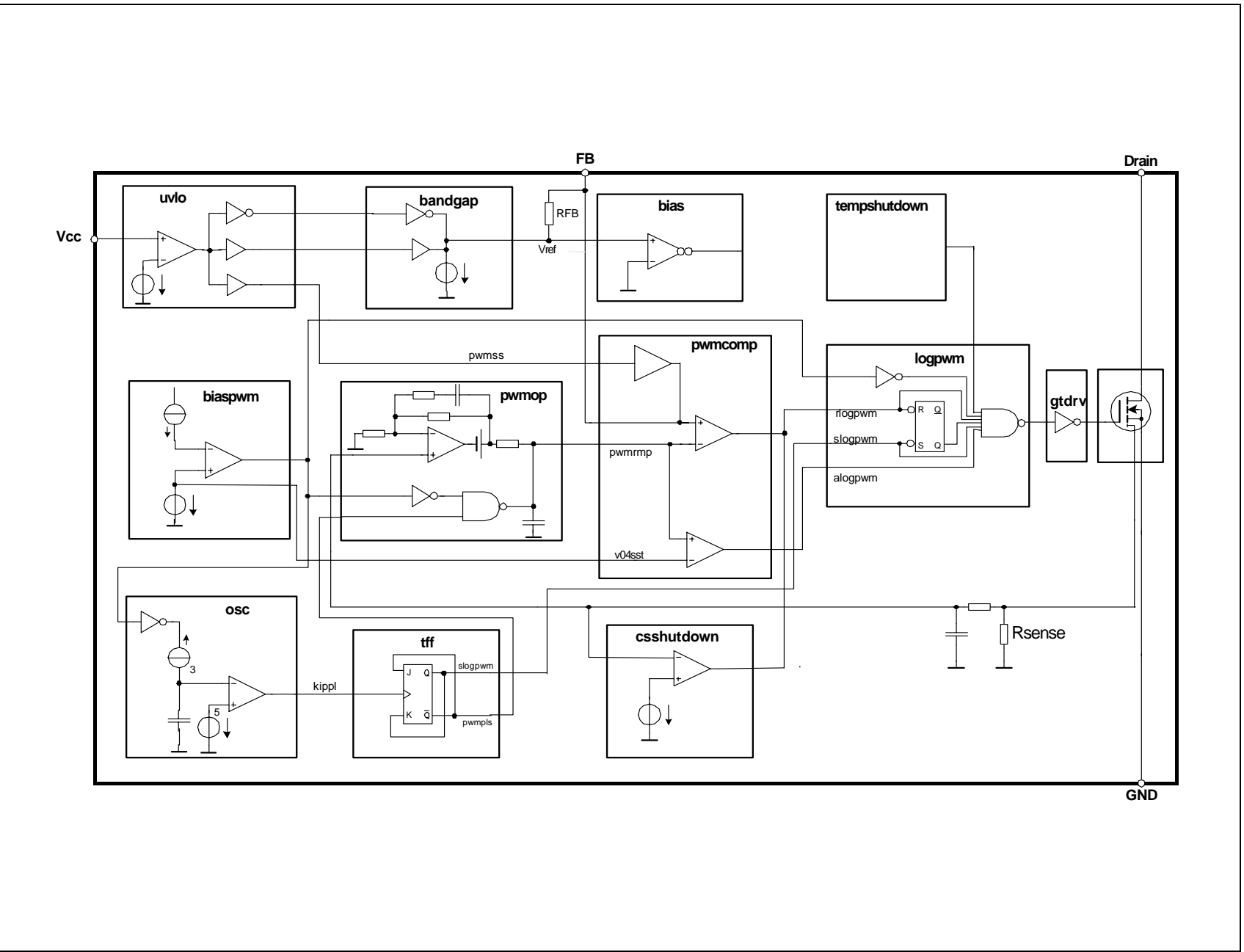

Figure 3 Block Diagram

Circuit Description

The TDA 16831-4 is a current mode pulse width modulator with integrated sense CoolMOS transistor. It fulfills the requirements of minimum external control circuitry for a flyback application.

Current mode control means that the current through the MOS transistor is compared with a reference signal derived from the output voltage of the flyback application. The result of that comparison determines the on time of the MOS transistor.

To minimize external circuitry the sense resistor which gives information about MOS current is integrated. The oscillator resistor and capacitor which determine the switching frequency are integrated, too. Special efforts have been made to compensate temperature dependency and to minimize tolerances of this resistor.

The circuit in detail: (see **Figure 3**)

Start Up Circuit (uvlo)

Uvlo is monitoring the external supply voltage V_{CC} . When V_{CC} is exceeding the on threshold $V_{CCH} = 12\text{ V}$, the bandgap, the bias circuit and the soft start circuit are switched on. When V_{CC} is falling below the off-threshold $V_{CCL} = 9\text{ V}$ the circuit is switched off. During start up the current consumption is about $30\text{ }\mu\text{A}$.

Bandgap (bg)

The bandgap generates an internal very accurate reference voltage of 5.5 V to supply the internal circuits.

Current Source (bias)

The bias circuit provides the internal circuits with constant current.

Oscillator (osc)

The oscillator is generating a frequency twice the switching frequency $f_{\text{switch}} = 100\text{ kHz}$. Resistor, capacitor and current source which determine the frequency are integrated. The charging and discharging current of the implemented oscillator capacitor is internally trimmed, in order to achieve a very accurate switching frequency. Temperature coefficient of switching frequency is very low (see page 19).

Divider Flip Flop (tff)

Tff is a flip flop which divides the oscillator frequency by one half to create the switching frequency. The maximum duty cycle is set to $D_{\text{max}} = 0.5$.

Current Sense Amplifier (pwmop)

The positive input of the pwmop is applied to the internal sense resistor. With the internal sense resistor (R_{sense}) the sensed current coming from the CoolMOS is converted into a sense voltage. The sense voltage is amplified with a gain of 32 dB . The amplified sense voltage is connected to the negative input of the pwm comparator. Each time when the CoolMOS transistor is switched on, a current spike is superposed to the true current information. To eliminate this current spike the sense voltage is smoothed via an internal resistor capacitor network with a time constant of $T_{d1} = 100\text{ ns}$. This is the first leading edge blanking and only a small spike is left. To reduce this small spike the current sense amplifier is creating a virtual ramp at the output. This is done by a second resistor capacitor network with $T_{d2} = 100\text{ ns}$ and an op-offset of 0.8 V which is seen at the output of the amplifier. When gate drive is

switched off the output capacitor is discharged via pulse signal pwmp. The oscillator signal slogpwm sets the RS-flip-flop. The gate drive circuit is switched on, when capacitor voltage exceeds the internal threshold of 0.4 V. This leads to a linear ramp, which is created by the output of the amplifier. Therefore duty cycle of 0 % is possible. The amplifier is compensated through an internal compensation network.

The transfer function of the amplifier can be described as

$$\frac{V_o}{V_i} = \frac{K_i}{p \times (1 + T \times p)}; p = j\omega$$

the step response is described with

$$V_o = V_i \times K_i \times \left(t_{on} - T + T \times e^{-\frac{t_{on}}{T}} \right)$$

$$K_i = \frac{40}{t_{on}}$$

$$T = 850 \text{ ns}$$

Comparator (pwmcomp)

The comparator pwmcomp compares the amplified current signal pwmp of the CoolMOS with the reference signal pwmin. Pwmin is created by an external optocoupler or external transistor and gives the information of the feedback circuitry. When the pwmp exceeds the reference signal pwmin the comparator switches the CoolMOS off.

Logic (logpwm)

The logic logpwm comprises a RS-flip-flop and a NAND-gate. The NAND-gate insures that CoolMOS transistor is only switched on when sosta is on and pwmin has exceeded minimum threshold and pwmin is below pwmp and currentshutdown is off and tempshutdown is off and tff sets the starting impulse. CoolMOS transistor is switched off when pwmp exceeds pwmin or duty cycle exceeds 0.5 or pwmc exceeds I_{max} or silicium temperature exceeds T_{max} or uvlo is going below threshold. The RS flip flop ensures that with every frequency period only one switch on can occur (double pulse suppression).

Gate Drive (gtdrv)

Gtdrv is the driver circuit for the CoolMOS and is optimized to minimize EMI influences and to provide high circuit efficiency. This is done by smoothing the switch on slope when reaching the CoolMOS threshold. Leading switch on spike is minimized then. When CoolMOS is witted off, the falling slope of the gate driver is slowed down when reaching 2 V. So an overshoot below ground can't occur. Also gate drive circuit is designed to eliminate cross conduction of the output stage.

Current Shut Down (cssd)

Current shut down circuit switches the CoolMOS immediately off when the sense current is exceeding an internal threshold of 100 mV at R_{sense} .

Tempshutdown (tsd)

Tempshutdown switches the CoolMOS off when junction temperature of the PWM controller is exceeding an internal threshold.

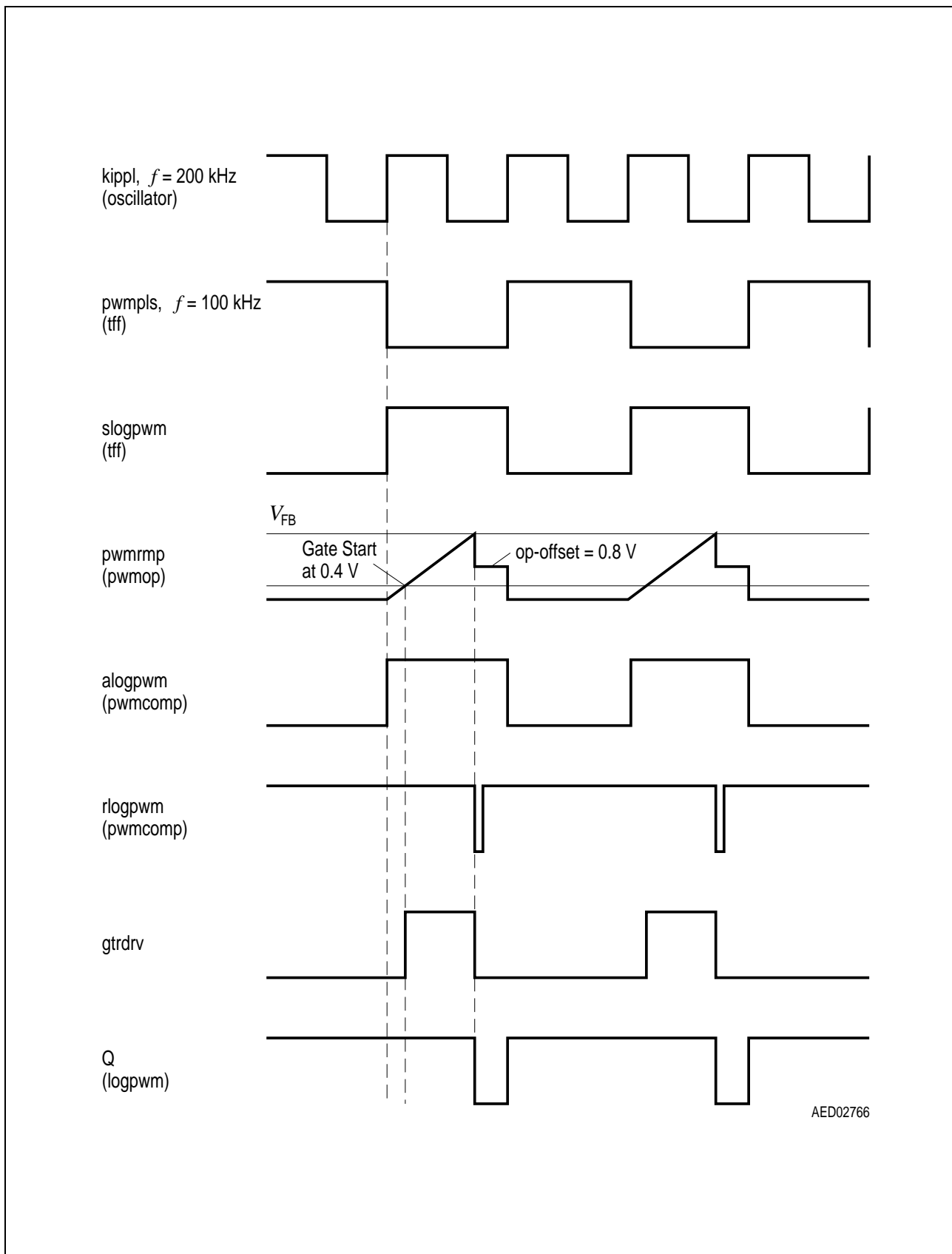

Figure 4 Signal Diagram

Electrical Characteristics
Absolute Maximum Ratings

Parameter	Symbol	Limit Values		Unit	Remarks
		min.	max.		
Supply Voltage	V_{CC}	- 0.3	V_Z	V	Zener Voltage ¹⁾ page 11
Supply + Zener Current	I_{CCZ}	0	20	mA	Beware of P_{max} ²⁾
Drain Source Voltage	V_{DS}		600	V	
Avalanche Current	I_{AC}		$I_{csthmax}$		$t = 100$ ns
Voltage at FB	V_{FB}	- 0.3	5.5	V	
Junction Temperature	T_j	- 40	150	°C	
Storage Temperature	T_{stg}	- 50	150	°C	
Thermal Resistance System-Air	R_{thSA}		90	K/W	P-DIP-8-6
	R_{thSA}		125	K/W	P-DSO-14-11

¹⁾ Be aware that V_{CC} capacitor is discharged before IC is plugged into the application board.

²⁾ Power dissipation should be observed.

Operating Range

Parameter	Symbol	Limit Values		Unit	Remarks
		min.	max.		
Supply Voltage	V_{CC}	V_{CCH}	V_Z	V	
Junction Temperature	T_j	- 25	120	°C	

Supply Section
 $-25\text{ °C} < T_j < 120\text{ °C}, V_{CC} = 15\text{ V}$

Parameter	Symbol	Limit Values			Unit	Test Conditions
		min.	typ.	max.		
Quiescent Current	I_{CCL}		25	80	μA	
Supply Current Active	I_{CCHA}		4.5	6	mA	TDA 16831/2/G
Supply Current Active	I_{CCHA}		6	7.5	mA	TDA 16833/G
Supply Current Active	I_{CCHA}		7	8.5	mA	TDA 16834
V_{CC} Turn-On Threshold	V_{CCH}		12	12.5	V	
V_{CC} Turn-Off Threshold	V_{CCL}	8.5	9		V	
V_{CC} Turn-On/Off Hysteresis	V_{CCHY}		3		V	
V_{CC} Zener Clamp	V_Z	16	17.5	19	V	
Controller Thermal Shutdown	T_{jSD}	120	135	150	$^{\circ}\text{C}$	TDA 16831/2/3/G/4
Thermal Hysteresis	T_{jHy}		2		$^{\circ}\text{C}$	

Oscillator Section
 $-25\text{ °C} < T_j < 120\text{ °C}, V_{CC} = 15\text{ V}$

Parameter	Symbol	Limit Values			Unit	Test Conditions
		min.	typ.	max.		
Accuracy	f	90	100	110	kHz	
Temperature Coefficient	TK f		1000		$\text{ppm}/^{\circ}\text{C}$	

PWM Section

Parameter	Symbol	Limit Values			Unit	Test Conditions
		min.	typ.	max.		
Duty Cycle	D	0		0.5		
Trans Impedance $\Delta V_{FB} / \Delta I_{Drain}$ ²⁾	Z_{PWM}		4		V/A	TDA16831/G
	Z_{PWM}		2		V/A	TDA16832/G
	Z_{PWM}		1.3		V/A	TDA16833/G/4
OP Gain Bandwidth ¹⁾	Bw		2		MHz	
OP Phase Margin ¹⁾	Φ_{m}		70		degree	
V_{FB} Operating Range min. Level	V_{FBmin}	0.45		0.85	V	for D = 0 $I_{CS} = 0.95 I_{csth}$
V_{FB} Operating Range max. Level	V_{FBmax}	3.5		4.8	V	
Feedback Resistance	R_{FB}	3.0	3.7	4.9	K Ω	
Temperature Coefficient R_{FB}	R_{FBTK}		600		ppm/ $^{\circ}$ C	
Internal Reference Voltage	V_{refint}	5.3	5.5	5.7	V	
Temperature Coefficient V_{refint}	V_{reftk}		0.2		mV/ $^{\circ}$ C	

1) Guaranteed by design

2) For discontinuous mode the V_{FB} is described by:

$$V_{FB} = Z_{PWM} \times \frac{I_{PK}}{t_{on}} \times \left(t_{on} - T_1 + T_1 \times e^{-\frac{t_{on}}{T_1}} \right) + 0.6 \times \left(1 - e^{-\frac{t_{on}}{T_2}} \right)$$

$$T_1 = 850 \text{ ns}; T_2 = 200 \text{ ns}$$

i
Output Section

Parameter	Symbol	Limit Values			Unit	Test Conditions
		min.	typ.	max.		
Drain Source Breakdown Voltage	$V_{(BR)DSS}$	600			V	$T_A = 25\text{ }^\circ\text{C}$
Drain Source On-Resistance	R_{Dson}		3.5		Ω	$T_A = 25\text{ }^\circ\text{C}$: TDA 16831/2/G
	R_{Dson}		1		Ω	TDA 16833/G
	R_{Dson}		0.5		Ω	TDA 16834
	R_{Dson}			9	Ω	$-25 < T_A < 120\text{ }^\circ\text{C}$: TDA 16831/2/G
	R_{Dson}			2.7	Ω	TDA 16833/G
	R_{Dson}			1.6	Ω	TDA 16834
Zero Gate Voltage Drain Current	I_{DSS}		0.5	50	μA	$V_{GS} = 0$
Output Capacitance	C_{OSS}		25		pF	TDA 16833
Avalanche Current	I_{AR}		$I_{csthmax}$		A	$t_{DR} = 100\text{ ns}$
I_{source} Current Limit Threshold	I_{csth}	0.6	0.9	1.4	A	TDA 16831/G
	I_{csth}	1.2	1.8	2.7	A	TDA 16832/G
	I_{csth}	2.2	2.9	4.8	A	TDA 16833/G
	I_{csth}	2.2	2.9	4.8	A	TDA 16834
Time Constant I_{csth}	t_{csth}		300		ns	
Rise Time	t_{rise}		70		ns	
Fall Time	t_{fall}		50		ns	

Application Circuit

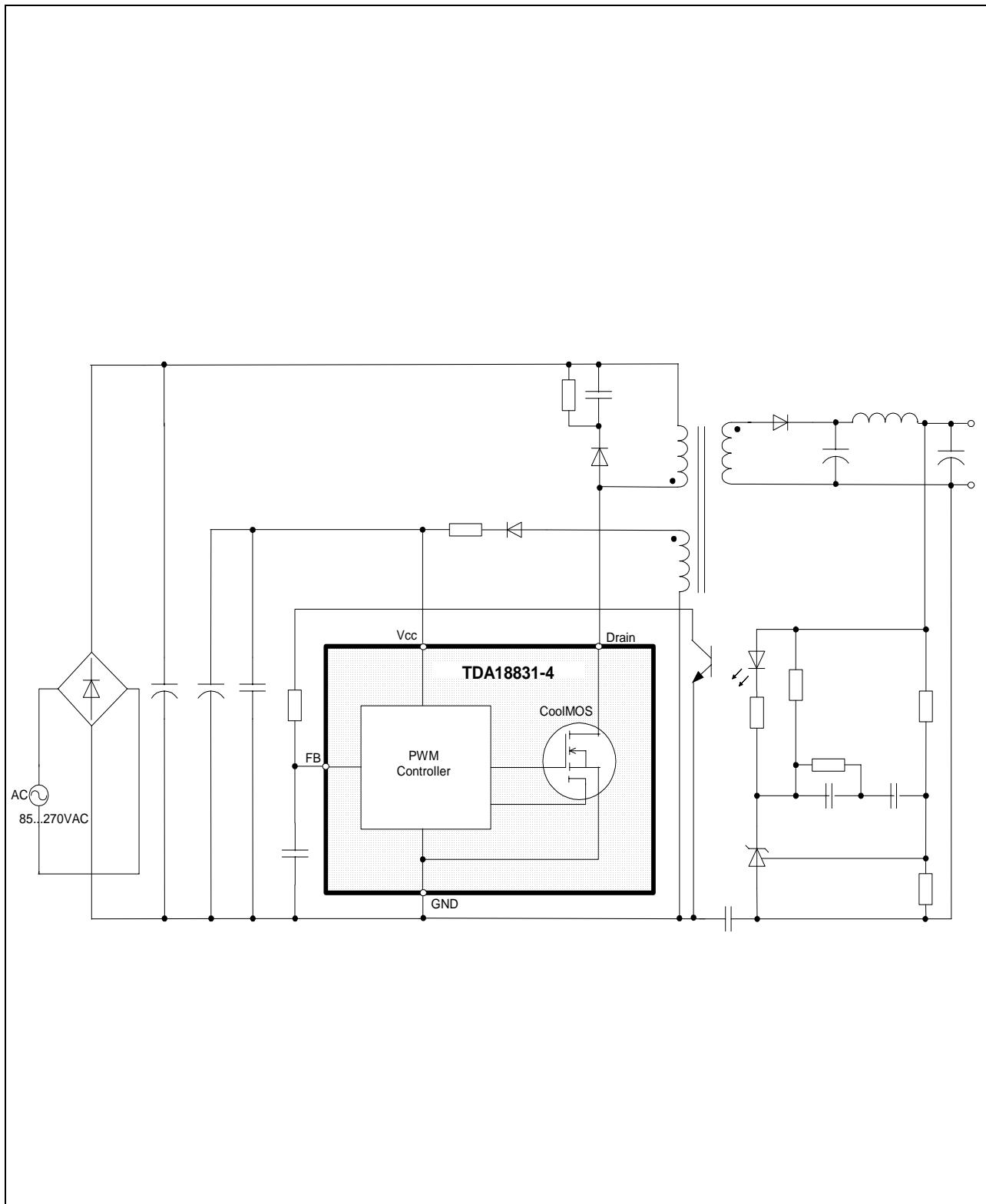
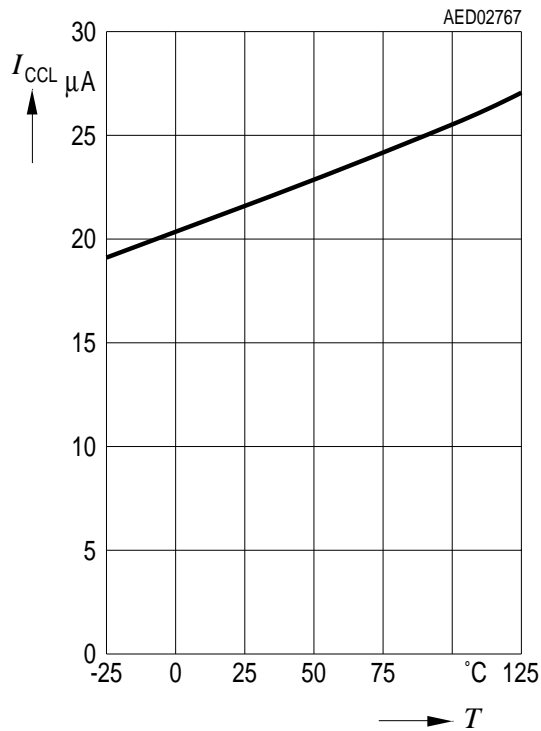
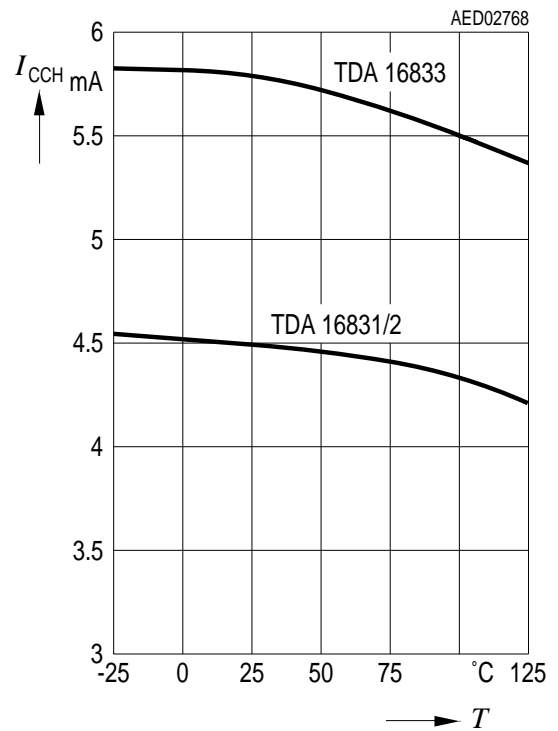

Figure 5 TDA 16831G/2G/3G: 4 Active Pins, Version without Soft Start

Quiescent Current versus Temperature



Supply Current Active versus Temperature



Turn On/Off Supply Voltage versus Temperature

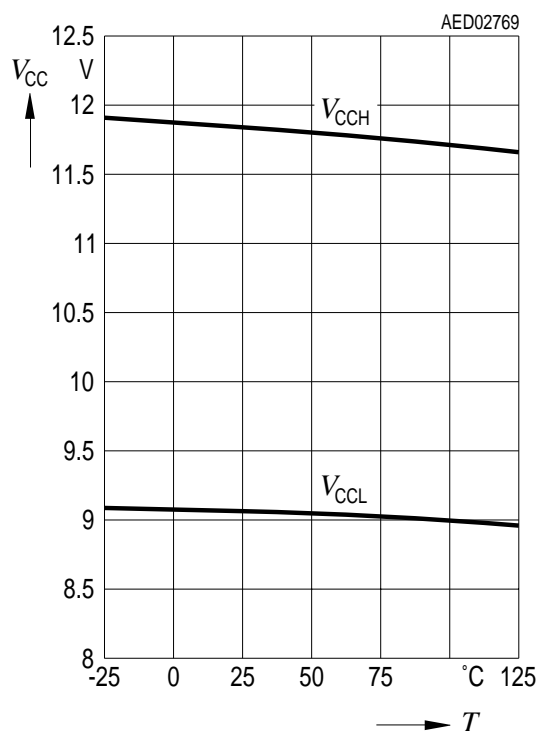

Turn On/Off Hysteresis

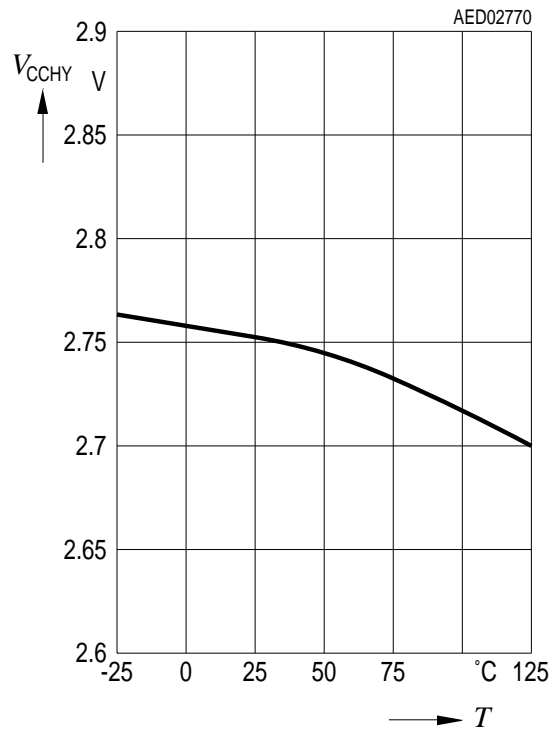

V_{CC} Zener Clamp

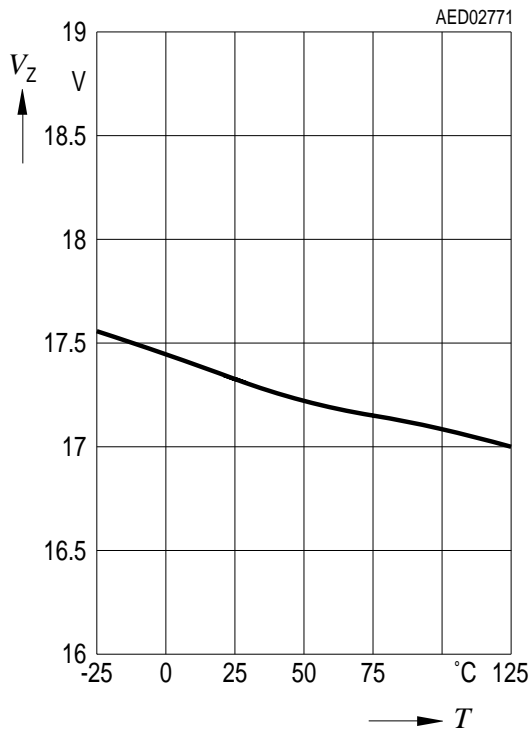

Switching Frequency versus Temperature

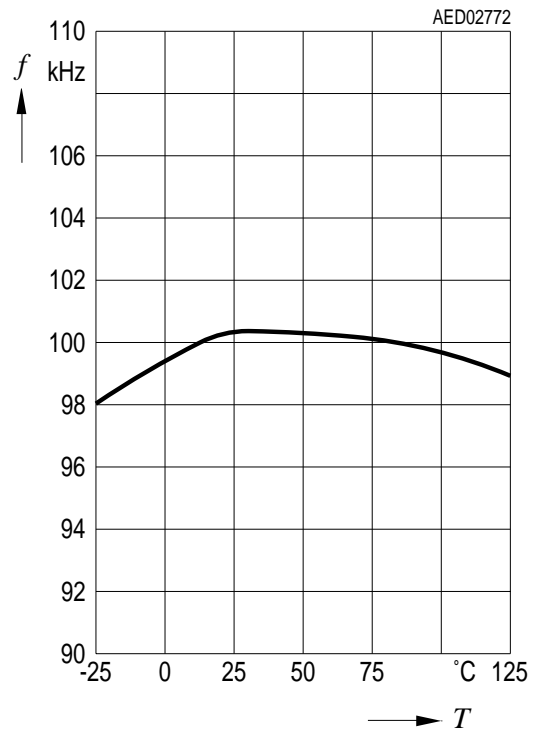

Maximum Duty Cycle versus Temperature TDA 16831/2/3/G/4

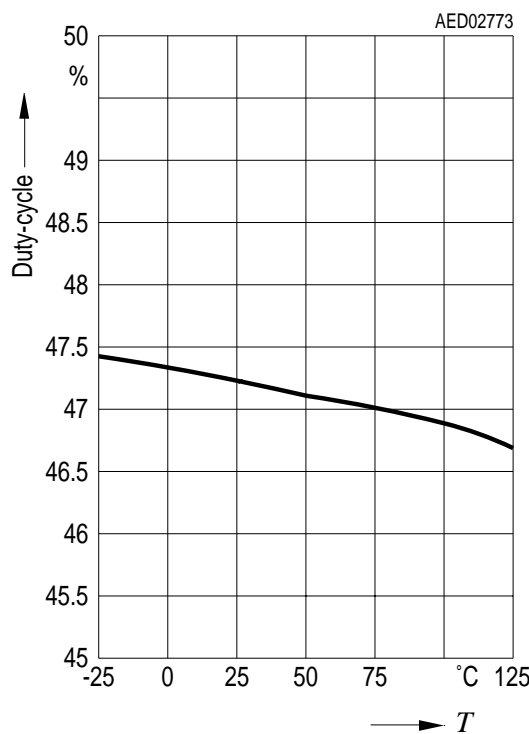

Operational Amplifier Phase and Amplitude versus Frequency

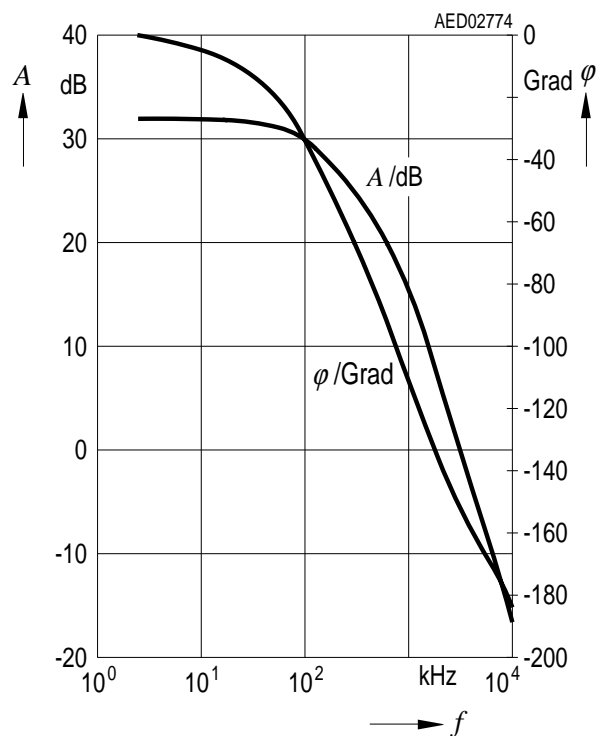

Feedback Voltage Operating Range versus Temperature

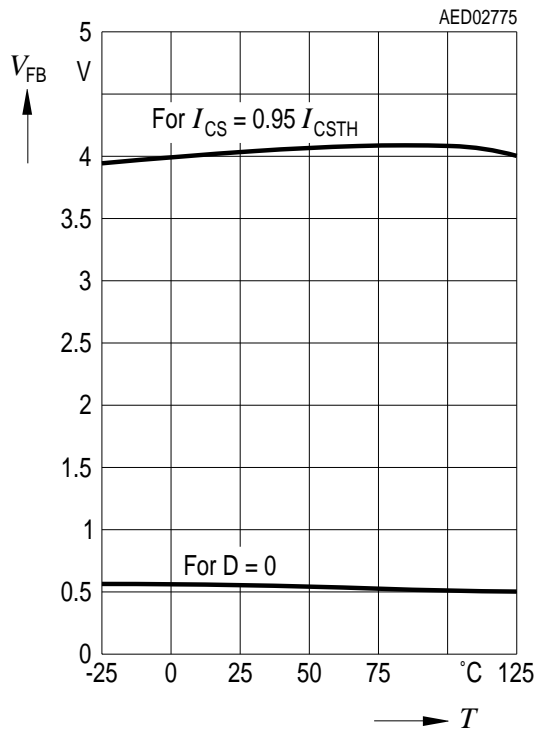

Feedback Voltage versus Feedback Current

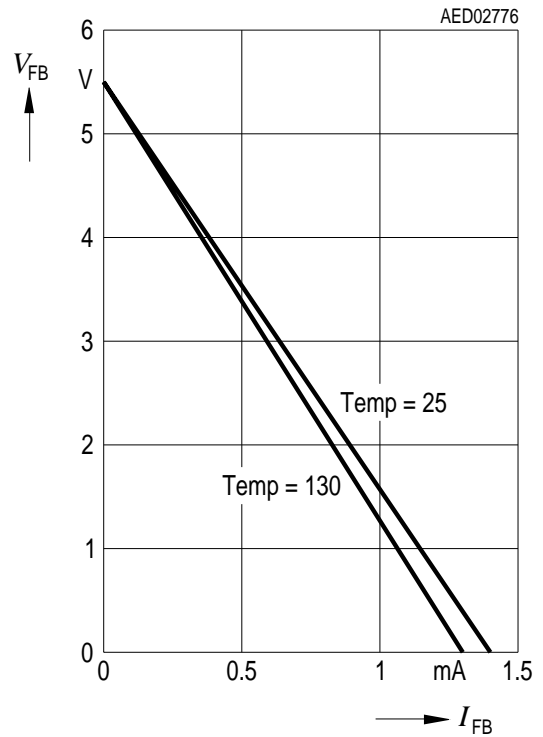

R_{DSON} versus Temperature

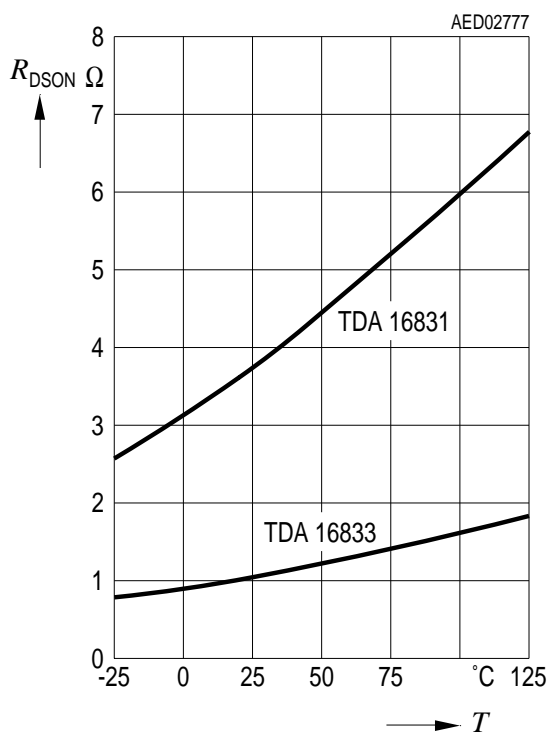

TDA 16833 Output Capacitance C_{OSS} versus V_{DS}

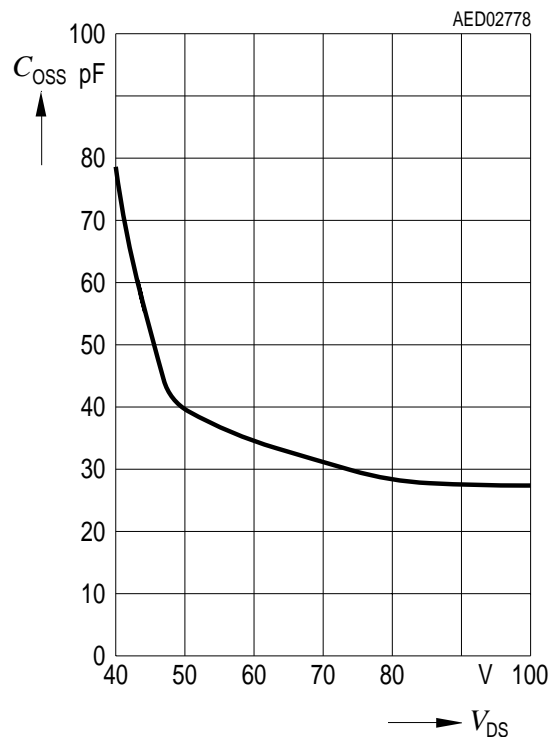

I_{source} Current Limit Threshold I_{csth} versus Temperature

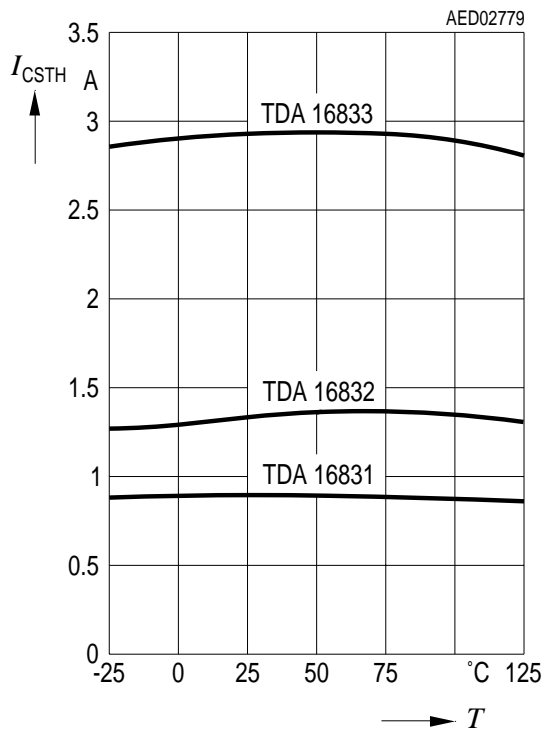

Normalized Overcurrent Shutdown versus Drain Current Slope

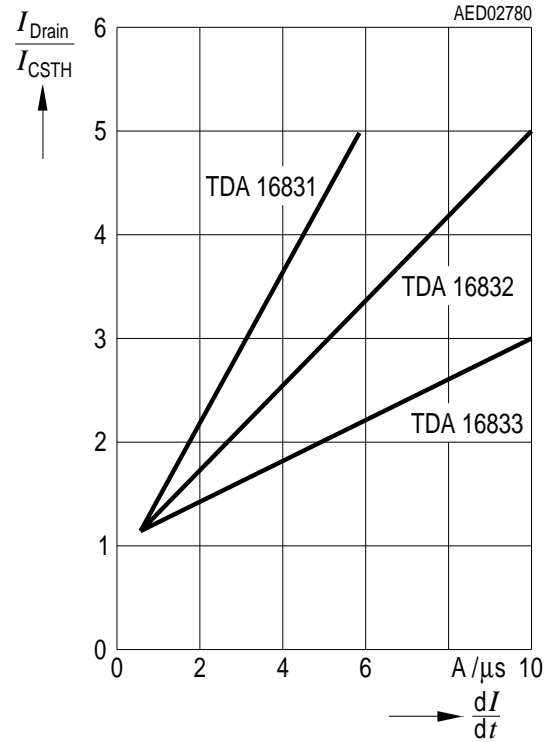

Package Outlines

P-DIP-8-6
(Plastic Dual In-line Package)

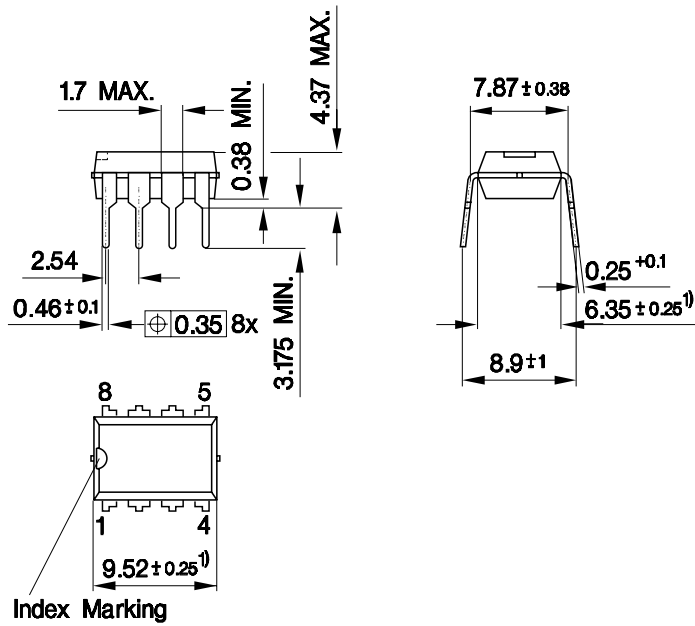

Index Marking

1) Does not include plastic or metal protrusion of 0.25 max. per side

GPD05583

P-DSO-14-11
(Plastic Dual Small Outline)

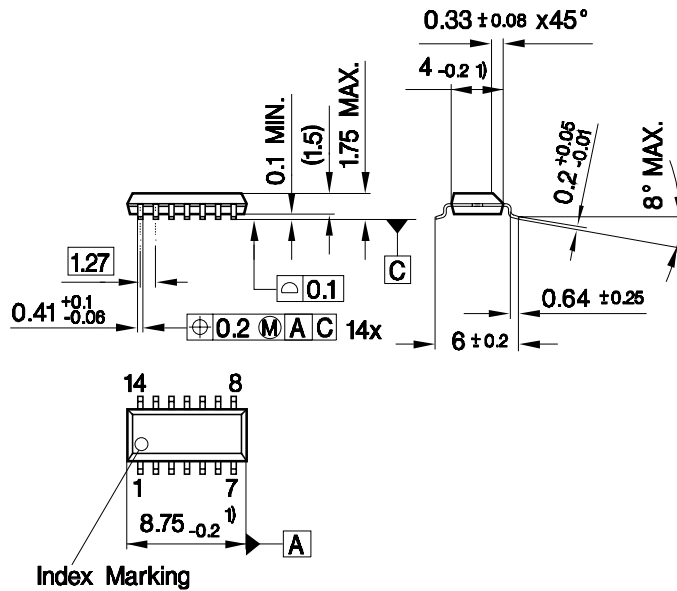

1) Does not include plastic or metal protrusion of 0.15 max. per side

GPS09222

Sorts of Packing

Package outlines for tubes, trays etc. are contained in our Data Book "Package Information".

SMD = Surface Mounted Device

Dimensions in mm

TDA 16831-4		
Revision History:		Current Version: 1999-11-08
Previous Version:		
Page (in previous Version)	Page (in current Version)	Subjects (major changes since last revision)

Published by Infineon Technologies AG i. Gr.,
Bereichs Kommunikation, St.-Martin-Strasse 53
D-81541 München

© Infineon Technologies AG1999
All Rights Reserved.

Attention please!

The information herein is given to describe certain components and shall not be considered as warranted characteristics.

Terms of delivery and rights to technical change reserved.

We hereby disclaim any and all warranties, including but not limited to warranties of non-infringement, regarding circuits, descriptions and charts stated herein.

Infineon Technologies is an approved CECC manufacturer.

Information

For further information on technology, delivery terms and conditions and prices please contact your nearest Infineon Technologies Office in Germany or our Infineon Technologies Representatives worldwide (see address list).

Warnings

Due to technical requirements components may contain dangerous substances. For information on the types in question please contact your nearest Infineon Technologies Office.

Infineon Technologies Components may only be used in life-support devices or systems with the express written approval of Infineon Technologies, if a failure of such components can reasonably be expected to cause the failure of that life-support device or system, or to affect the safety or effectiveness of that device or system. Life support devices or systems are intended to be implanted in the human body, or to support and/or maintain and sustain and/or protect human life. If they fail, it is reasonable to assume that the health of the user or other persons may be endangered.