

Fast IGBT in NPT-technology with soft, fast recovery anti-parallel EmCon diode

- 40% lower E_{off} compared to previous generation
- Short circuit withstand time – 10 μ s
- Designed for:
 - Motor controls
 - Inverter
 - SMPS
- NPT-Technology offers:
 - very tight parameter distribution
 - high ruggedness, temperature stable behaviour
 - parallel switching capability

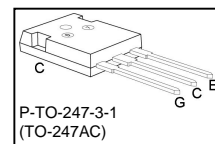
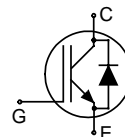

- Complete product spectrum and PSpice Models : <http://www.infineon.com/igbt/>

Type	V_{CE}	I_C	E_{off}	T_j	Package	Ordering Code
SKW15N120	1200V	15A	1.5mJ	150°C	TO-247AC	Q67040-S4281

Maximum Ratings

Parameter	Symbol	Value	Unit
Collector-emitter voltage	V_{CE}	1200	V
DC collector current	I_C	30	A
$T_C = 25^\circ\text{C}$		30	
$T_C = 100^\circ\text{C}$		15	
Pulsed collector current, t_p limited by T_{jmax}	I_{Cpuls}	52	
Turn off safe operating area	-	52	
$V_{CE} \leq 1200\text{V}, T_j \leq 150^\circ\text{C}$			
Diode forward current	I_F	32	
$T_C = 25^\circ\text{C}$		32	
$T_C = 100^\circ\text{C}$		15	
Diode pulsed current, t_p limited by T_{jmax}	I_{Fpuls}	50	
Gate-emitter voltage	V_{GE}	± 20	V
Short circuit withstand time ¹⁾	t_{SC}	10	μ s
$V_{GE} = 15\text{V}, 100\text{V} \leq V_{CC} \leq 1200\text{V}, T_j \leq 150^\circ\text{C}$			
Power dissipation	P_{tot}	198	W
$T_C = 25^\circ\text{C}$			
Operating junction and storage temperature	T_j, T_{stg}	-55...+150	°C
Soldering temperature, 1.6mm (0.063 in.) from case for 10s	-	260	

¹⁾ Allowed number of short circuits: <1000; time between short circuits: >1s.

Thermal Resistance

Parameter	Symbol	Conditions	Max. Value	Unit
Characteristic				
IGBT thermal resistance, junction – case	R_{thJC}		0.63	K/W
Diode thermal resistance, junction – case	R_{thJCD}		1.5	
Thermal resistance, junction – ambient	R_{thJA}	TO-247AC	40	

Electrical Characteristic, at $T_j = 25^\circ\text{C}$, unless otherwise specified

Parameter	Symbol	Conditions	Value			Unit
			min.	typ.	max.	
Static Characteristic						
Collector-emitter breakdown voltage	$V_{(BR)CES}$	$V_{GE}=0V, I_C=1000\mu A$	1200	-	-	V
Collector-emitter saturation voltage	$V_{CE(sat)}$	$V_{GE} = 15V, I_C=15A$ $T_j=25^\circ\text{C}$ $T_j=150^\circ\text{C}$	2.5 -	3.1 3.7	3.6 4.3	
Diode forward voltage	V_F	$V_{GE}=0V, I_F=15A$ $T_j=25^\circ\text{C}$ $T_j=150^\circ\text{C}$	-	2.0 1.75	2.5	
Gate-emitter threshold voltage	$V_{GE(th)}$	$I_C=600\mu A, V_{CE}=V_{GE}$	3	4	5	
Zero gate voltage collector current	I_{CES}	$V_{CE}=1200V, V_{GE}=0V$ $T_j=25^\circ\text{C}$ $T_j=150^\circ\text{C}$	- -	- -	200 800	μA
Gate-emitter leakage current	I_{GES}	$V_{CE}=0V, V_{GE}=20V$	-	-	100	
Transconductance	g_{fs}	$V_{CE}=20V, I_C=15A$		11	-	S
Dynamic Characteristic						
Input capacitance	C_{iss}	$V_{CE}=25V, V_{GE}=0V, f=1\text{MHz}$	-	1250	1500	pF
Output capacitance	C_{oss}		-	155	185	
Reverse transfer capacitance	C_{riss}		-	65	80	
Gate charge	Q_{Gate}	$V_{CC}=960V, I_C=15A$ $V_{GE}=15V$	-	130	175	nC
Internal emitter inductance measured 5mm (0.197 in.) from case	L_E	TO-247AC	-	13	-	nH
Short circuit collector current ¹⁾	$I_{C(SC)}$	$V_{GE}=15V, t_{SC}\leq 10\mu s$ $100V\leq V_{CC}\leq 1200V, T_j\leq 150^\circ\text{C}$	-	145	-	A

¹⁾ Allowed number of short circuits: <1000; time between short circuits: >1s.

Switching Characteristic, Inductive Load, at $T_j=25\text{ }^\circ\text{C}$

Parameter	Symbol	Conditions	Value			Unit
			min.	typ.	max.	
IGBT Characteristic						
Turn-on delay time	$t_{d(on)}$	$T_j=25\text{ }^\circ\text{C}$, $V_{CC}=800\text{V}$, $I_C=15\text{A}$, $V_{GE}=15\text{V}/0\text{V}$, $R_G=33\Omega$, $L_\sigma^{(1)}=180\text{nH}$, $C_\sigma^{(1)}=40\text{pF}$ Energy losses include "tail" and diode reverse recovery.	-	18	24	ns
Rise time	t_r		-	23	30	
Turn-off delay time	$t_{d(off)}$		-	580	750	
Fall time	t_f		-	22	29	
Turn-on energy	E_{on}		-	1.1	1.5	mJ
Turn-off energy	E_{off}		-	0.8	1.1	
Total switching energy	E_{ts}		-	1.9	2.6	

Anti-Parallel Diode Characteristic

Diode reverse recovery time	t_{rr}	$T_j=25\text{ }^\circ\text{C}$, $V_R=800\text{V}$, $I_F=15\text{A}$, $di_F/dt=650\text{A}/\mu\text{s}$	-	65		ns
	t_S		-			
	t_F		-			
Diode reverse recovery charge	Q_{rr}		-	0.5		μC
Diode peak reverse recovery current	I_{rrm}		-	15		A
Diode peak rate of fall of reverse recovery current during t_F	di_{rr}/dt	-	500		$\text{A}/\mu\text{s}$	

Switching Characteristic, Inductive Load, at $T_j=150\text{ }^\circ\text{C}$

Parameter	Symbol	Conditions	Value			Unit
			min.	typ.	max.	
IGBT Characteristic						
Turn-on delay time	$t_{d(on)}$	$T_j=150\text{ }^\circ\text{C}$ $V_{CC}=800\text{V}$, $I_C=15\text{A}$, $V_{GE}=15\text{V}/0\text{V}$, $R_G=33\Omega$, $L_\sigma^{(1)}=180\text{nH}$, $C_\sigma^{(1)}=40\text{pF}$ Energy losses include "tail" and diode reverse recovery.	-	38	46	ns
Rise time	t_r		-	30	36	
Turn-off delay time	$t_{d(off)}$		-	652	780	
Fall time	t_f		-	31	37	
Turn-on energy	E_{on}		-	1.9	2.3	mJ
Turn-off energy	E_{off}		-	1.5	2.0	
Total switching energy	E_{ts}		-	3.4	4.3	

Anti-Parallel Diode Characteristic

Diode reverse recovery time	t_{rr}	$T_j=150\text{ }^\circ\text{C}$ $V_R=800\text{V}$, $I_F=15\text{A}$, $di_F/dt=650\text{A}/\mu\text{s}$	-	200		ns
	t_S		-			
	t_F		-			
Diode reverse recovery charge	Q_{rr}		-	2.0		μC
Diode peak reverse recovery current	I_{rrm}		-	23		A
Diode peak rate of fall of reverse recovery current during t_F	di_{rr}/dt	-	140		$\text{A}/\mu\text{s}$	

¹⁾ Leakage inductance L_σ and stray capacity C_σ due to dynamic test circuit in figure E.

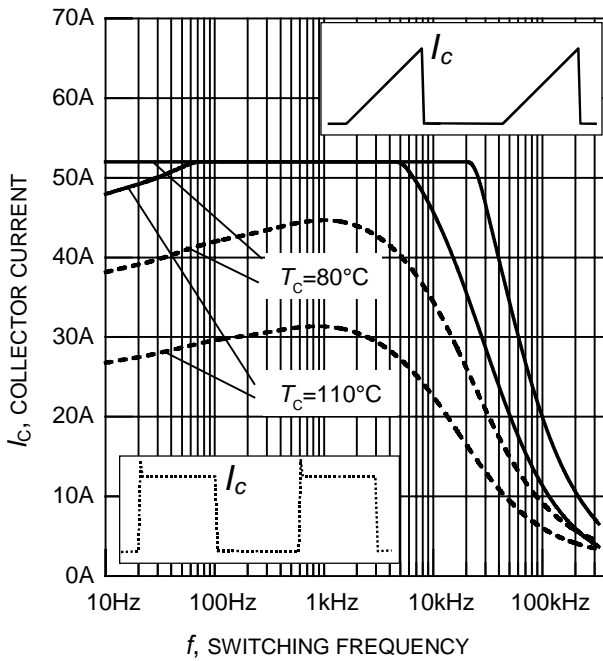

Figure 1. Collector current as a function of switching frequency

($T_j \leq 150^\circ\text{C}$, $D = 0.5$, $V_{CE} = 800\text{V}$, $V_{GE} = +15\text{V}/0\text{V}$, $R_G = 33\Omega$)

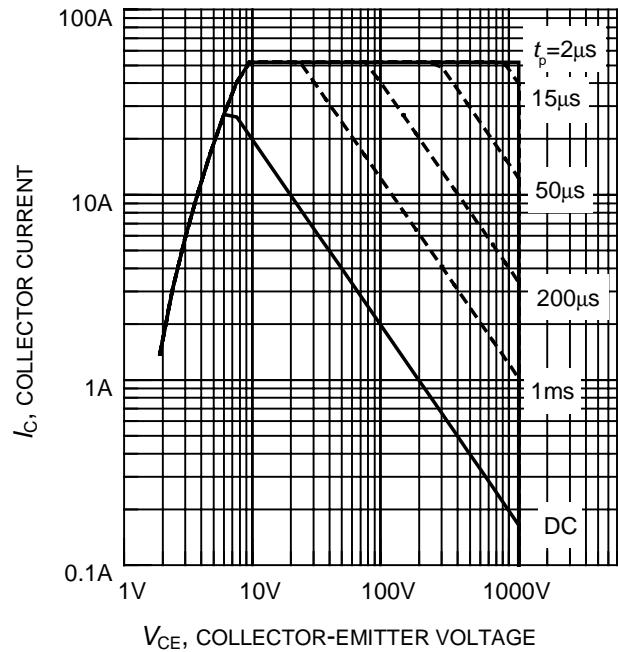

Figure 2. Safe operating area

($D = 0$, $T_C = 25^\circ\text{C}$, $T_j \leq 150^\circ\text{C}$)

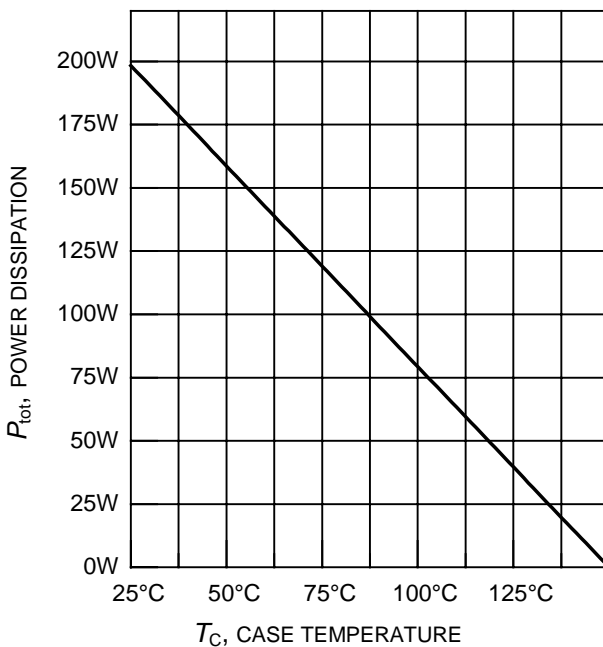

Figure 3. Power dissipation as a function of case temperature

($T_j \leq 150^\circ\text{C}$)

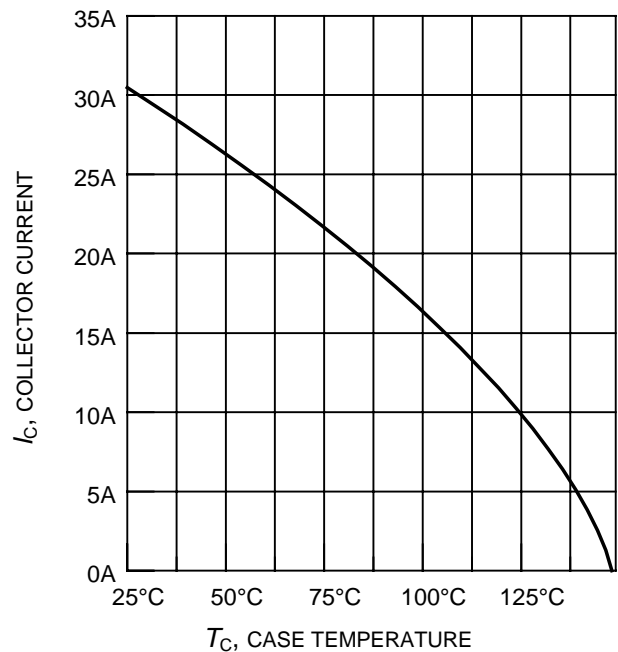

Figure 4. Collector current as a function of case temperature

($V_{GE} \leq 15\text{V}$, $T_j \leq 150^\circ\text{C}$)

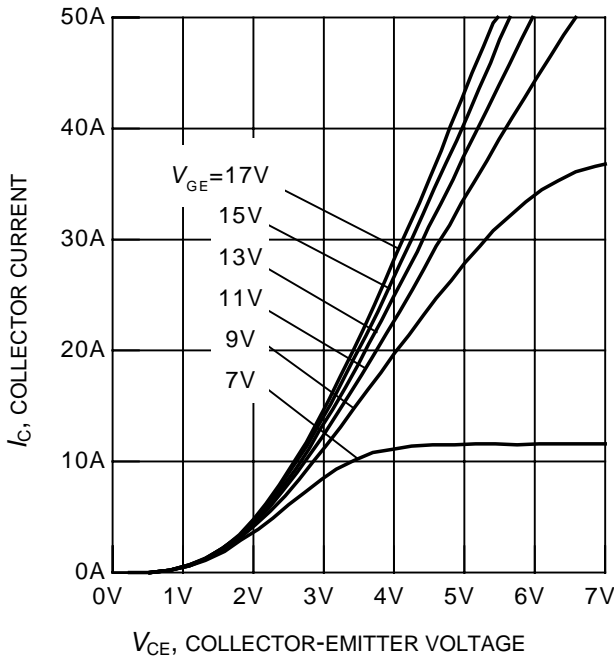

Figure 5. Typical output characteristics
($T_j = 25^\circ\text{C}$)

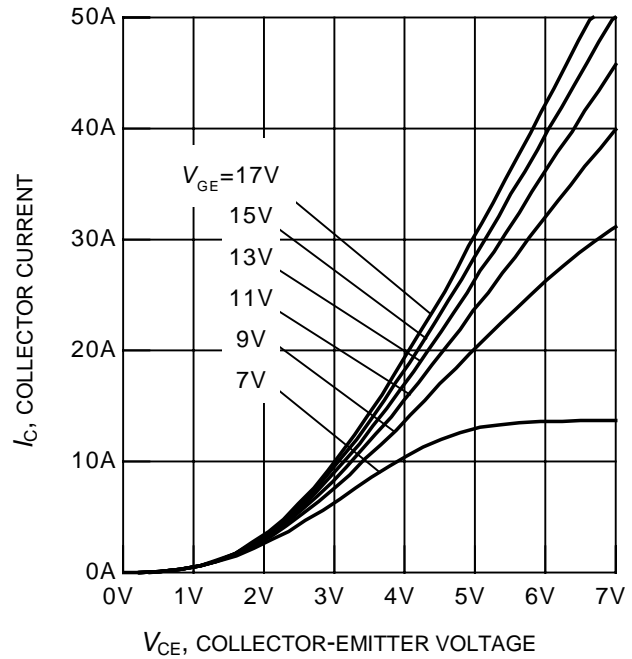

Figure 6. Typical output characteristics
($T_j = 150^\circ\text{C}$)

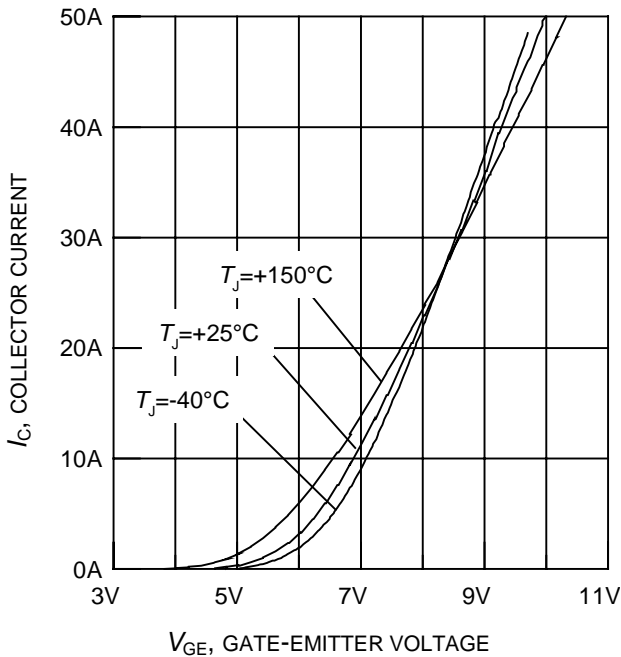

Figure 7. Typical transfer characteristics
($V_{CE} = 20\text{V}$)

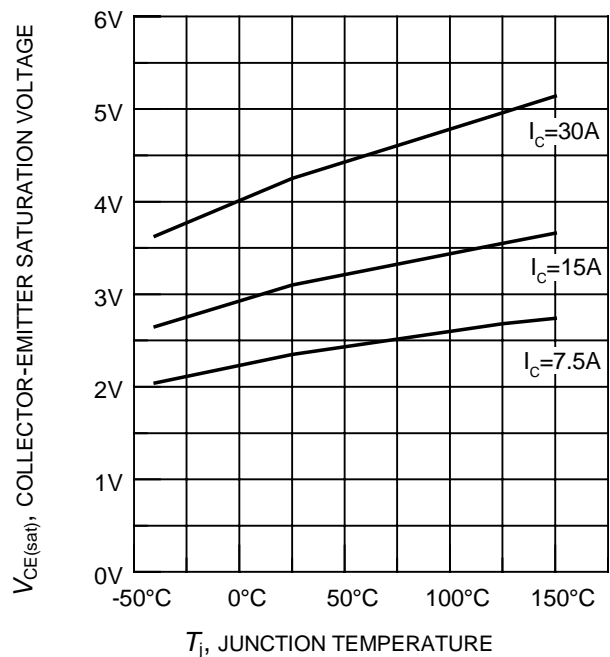

Figure 8. Typical collector-emitter saturation voltage as a function of junction temperature
($V_{GE} = 15\text{V}$)

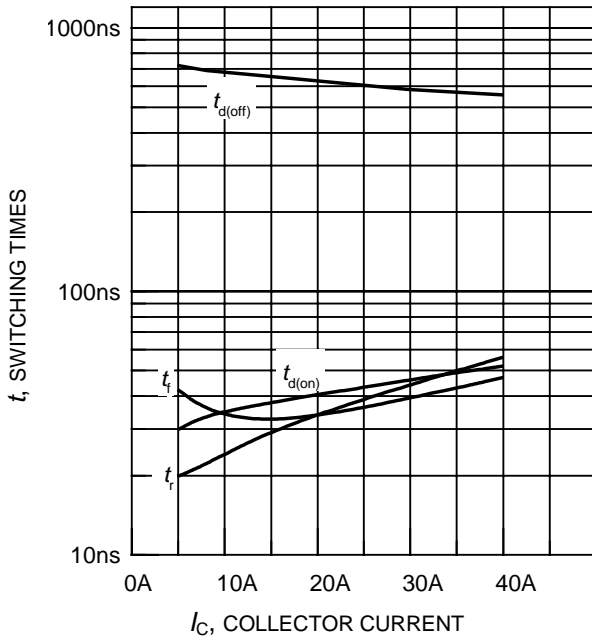

Figure 9. Typical switching times as a function of collector current
 (inductive load, $T_j = 150^\circ\text{C}$,
 $V_{CE} = 8600\text{V}$, $V_{GE} = +15\text{V}/0\text{V}$, $R_G = 33\Omega$,
 dynamic test circuit in Fig.E)

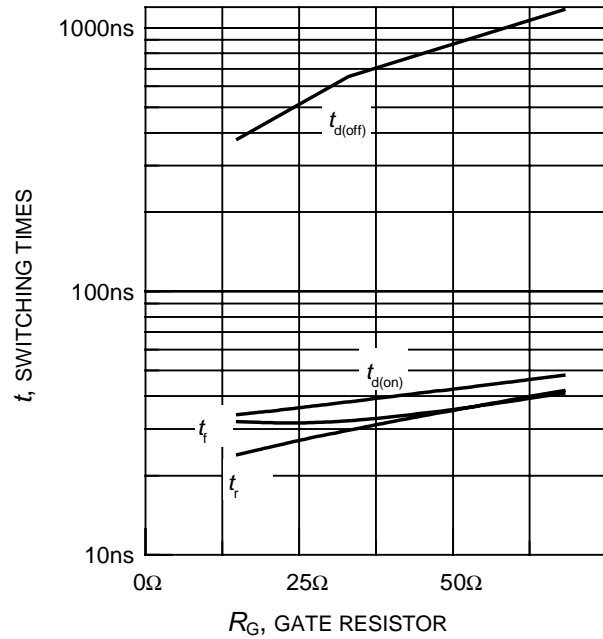

Figure 10. Typical switching times as a function of gate resistor
 (inductive load, $T_j = 150^\circ\text{C}$,
 $V_{CE} = 800\text{V}$, $V_{GE} = +15\text{V}/0\text{V}$, $I_C = 15\text{A}$,
 dynamic test circuit in Fig.E)

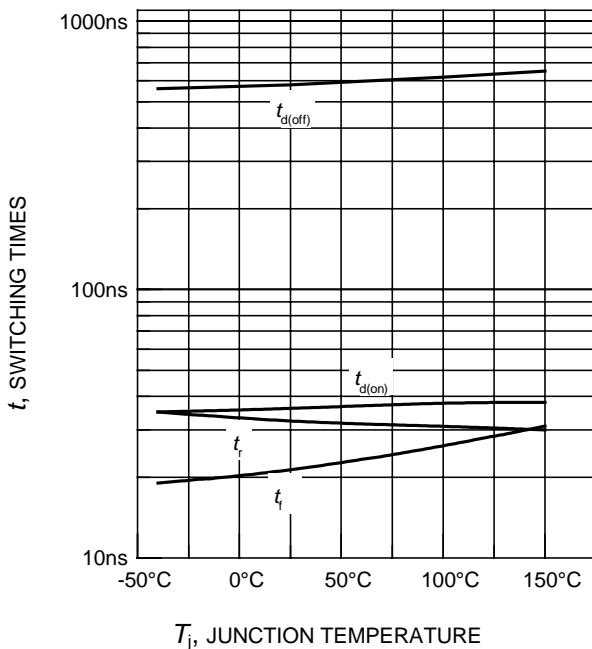

Figure 11. Typical switching times as a function of junction temperature
 (inductive load, $V_{CE} = 800\text{V}$,
 $V_{GE} = +15\text{V}/0\text{V}$, $I_C = 15\text{A}$, $R_G = 33\Omega$,
 dynamic test circuit in Fig.E)

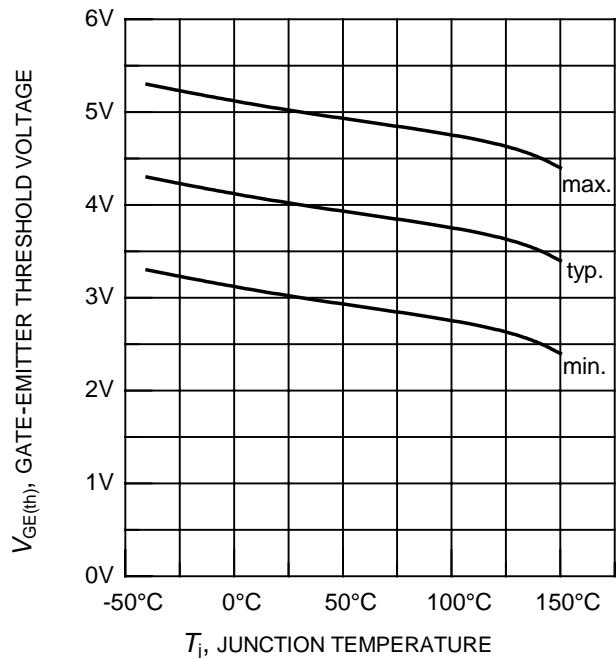

Figure 12. Gate-emitter threshold voltage as a function of junction temperature
 ($I_C = 0.3\text{mA}$)

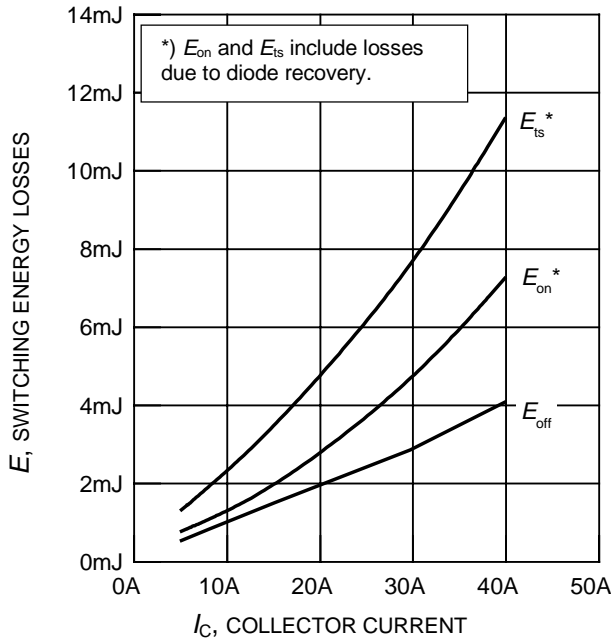

Figure 13. Typical switching energy losses as a function of collector current
 (inductive load, $T_j = 150^\circ\text{C}$, $V_{CE} = 800\text{V}$, $V_{GE} = +15\text{V}/0\text{V}$, $R_G = 33\Omega$, dynamic test circuit in Fig.E)

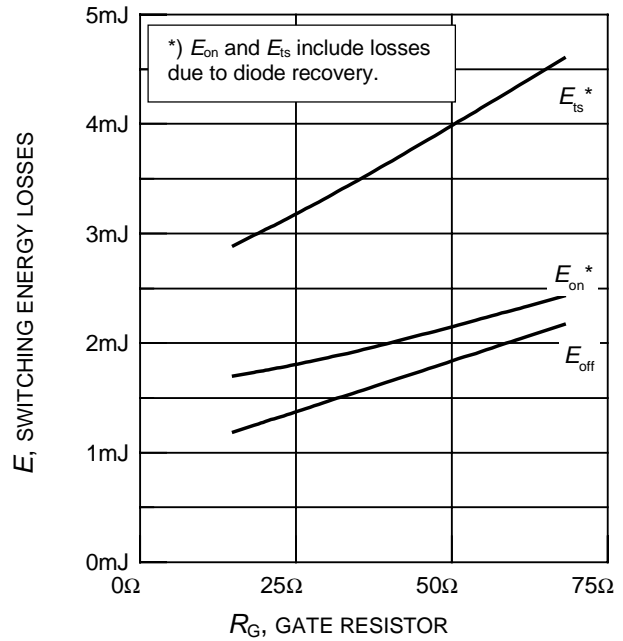

Figure 14. Typical switching energy losses as a function of gate resistor
 (inductive load, $T_j = 150^\circ\text{C}$, $V_{CE} = 800\text{V}$, $V_{GE} = +15\text{V}/0\text{V}$, $I_C = 15\text{A}$, dynamic test circuit in Fig.E)

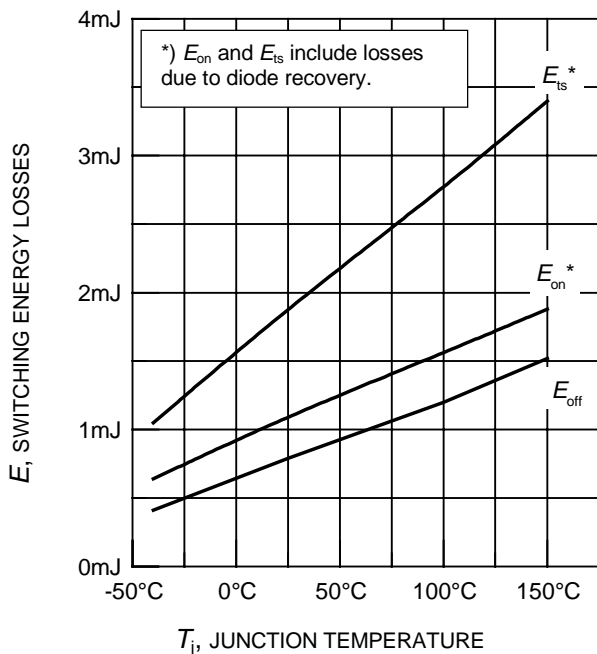

Figure 15. Typical switching energy losses as a function of junction temperature
 (inductive load, $V_{CE} = 800\text{V}$, $V_{GE} = +15\text{V}/0\text{V}$, $I_C = 15\text{A}$, $R_G = 33\Omega$, dynamic test circuit in Fig.E)

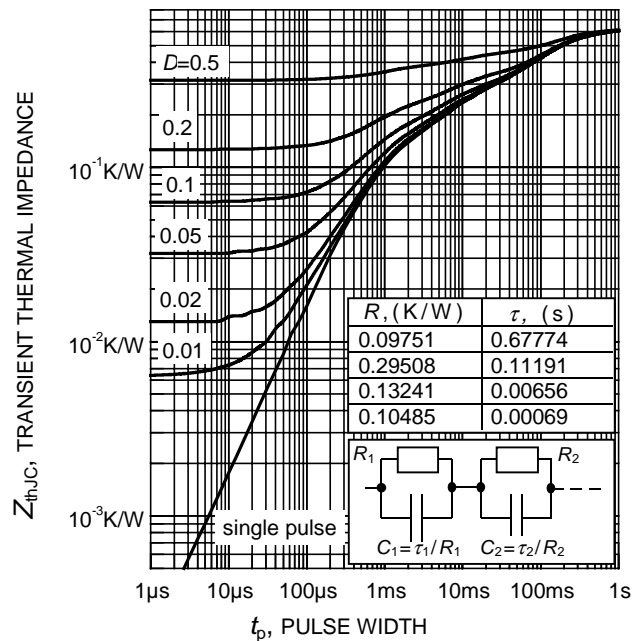

Figure 16. IGBT transient thermal impedance as a function of pulse width
 ($D = t_p / T$)

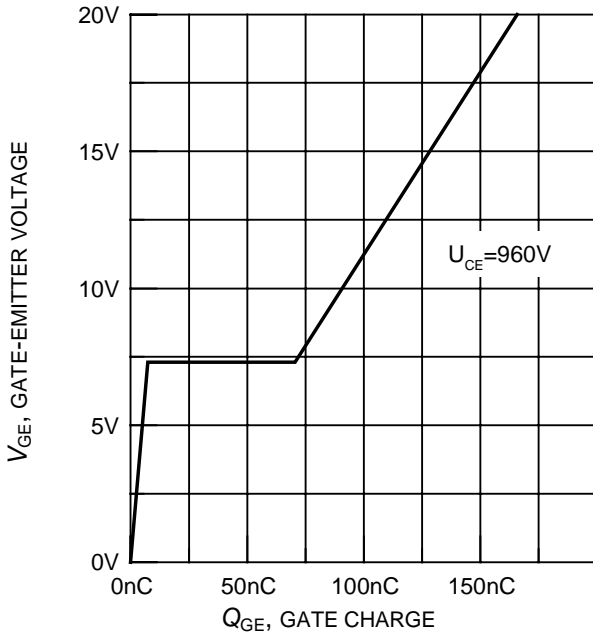

Figure 17. Typical gate charge
($I_C = 15A$)

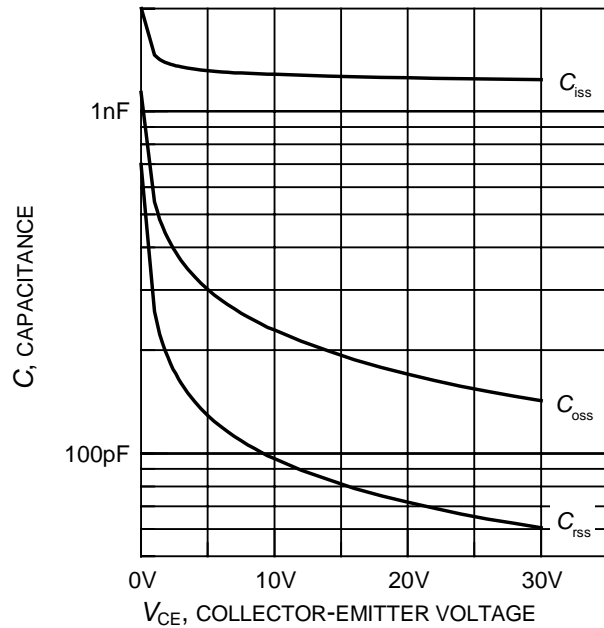

Figure 18. Typical capacitance as a function of collector-emitter voltage
($V_{GE} = 0V, f = 1MHz$)

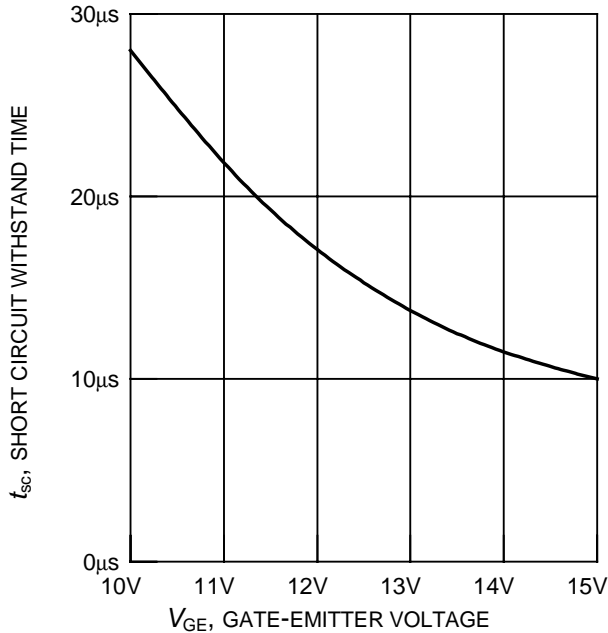

Figure 19. Short circuit withstand time as a function of gate-emitter voltage
($V_{CE} = 1200V, \text{start at } T_j = 25^\circ C$)

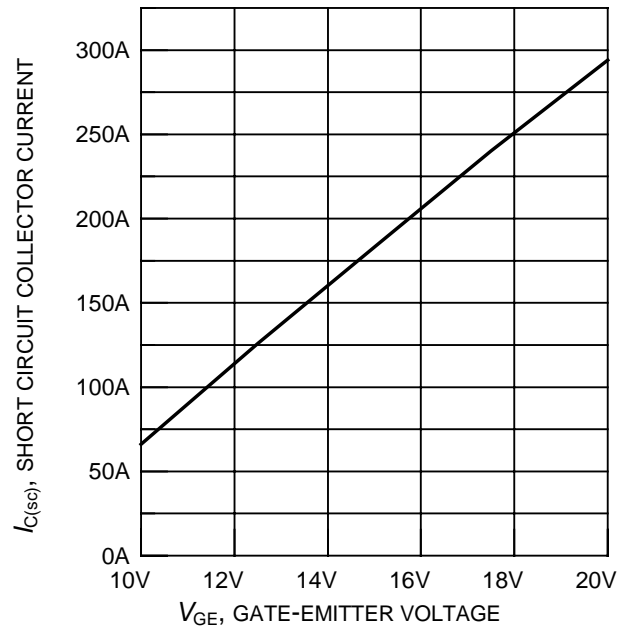

Figure 20. Typical short circuit collector current as a function of gate-emitter voltage
($100V \leq V_{CE} \leq 1200V, T_C = 25^\circ C, T_j \leq 150^\circ C$)

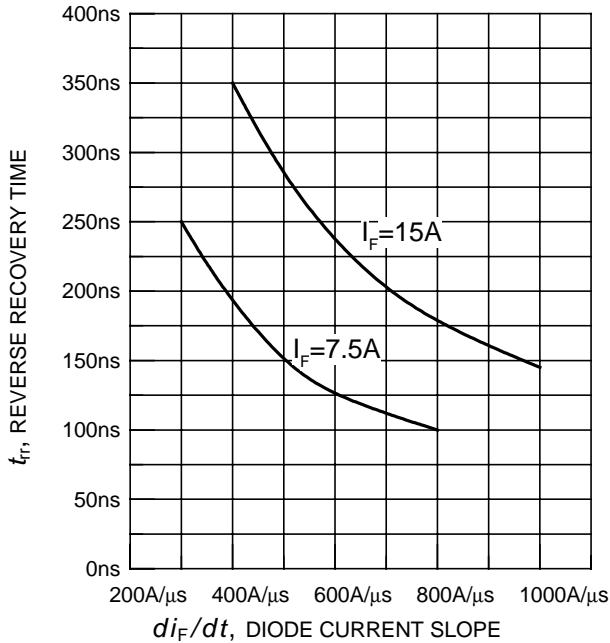

Figure 21. Typical reverse recovery time as a function of diode current slope
 ($V_R = 800V$, $T_j = 150^\circ C$, dynamic test circuit in Fig.E)

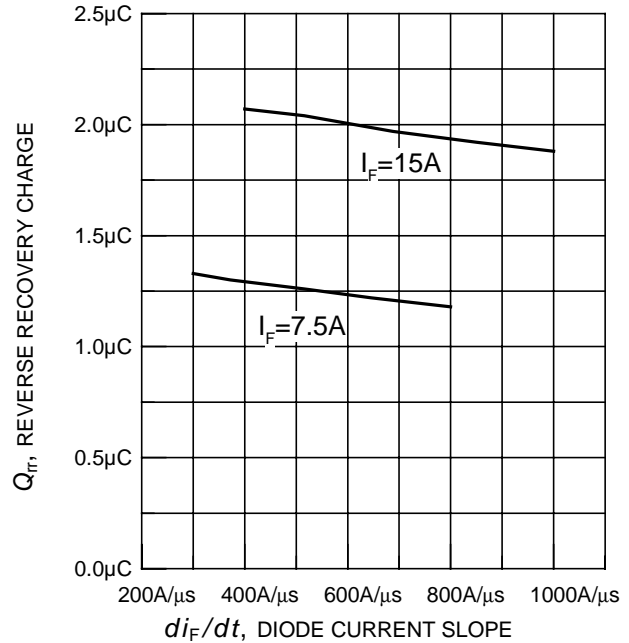

Figure 22. Typical reverse recovery charge as a function of diode current slope
 ($V_R = 800V$, $T_j = 150^\circ C$, dynamic test circuit in Fig.E)

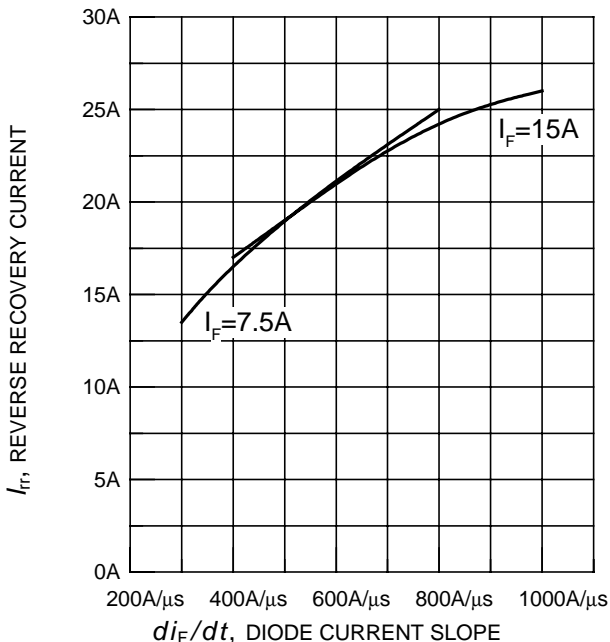

Figure 23. Typical reverse recovery current as a function of diode current slope
 ($V_R = 800V$, $T_j = 150^\circ C$, dynamic test circuit in Fig.E)

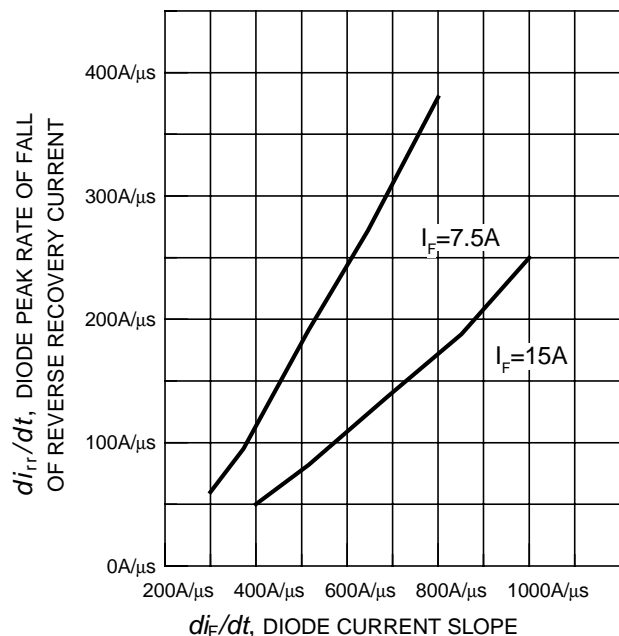

Figure 24. Typical diode peak rate of fall of reverse recovery current as a function of diode current slope
 ($V_R = 800V$, $T_j = 150^\circ C$, dynamic test circuit in Fig.E)

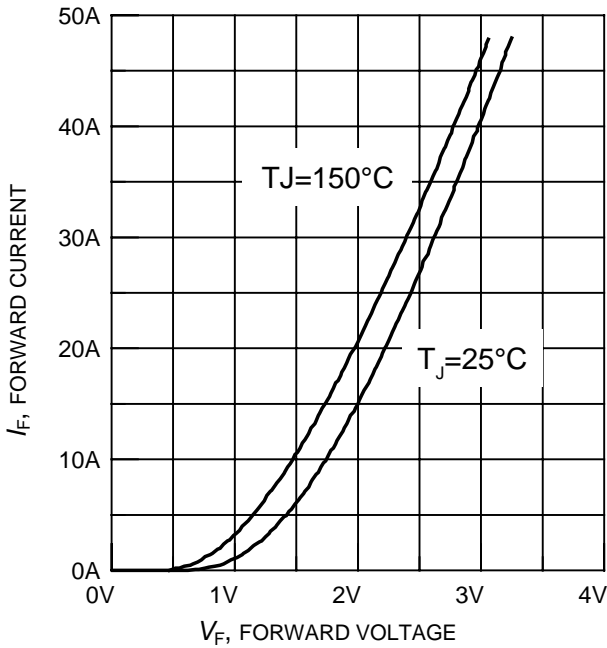

Figure 25. Typical diode forward current as a function of forward voltage

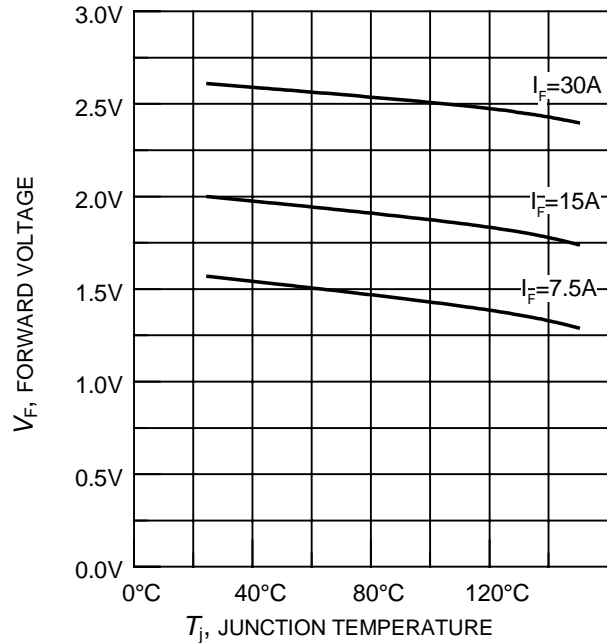

Figure 26. Typical diode forward voltage as a function of junction temperature

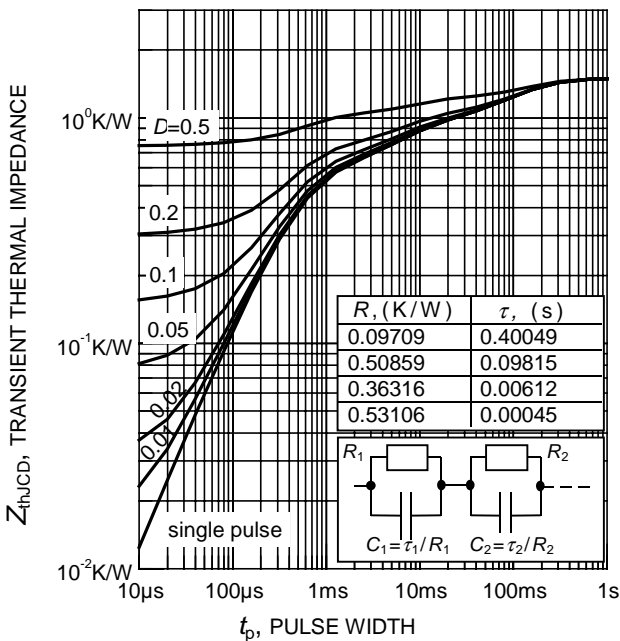
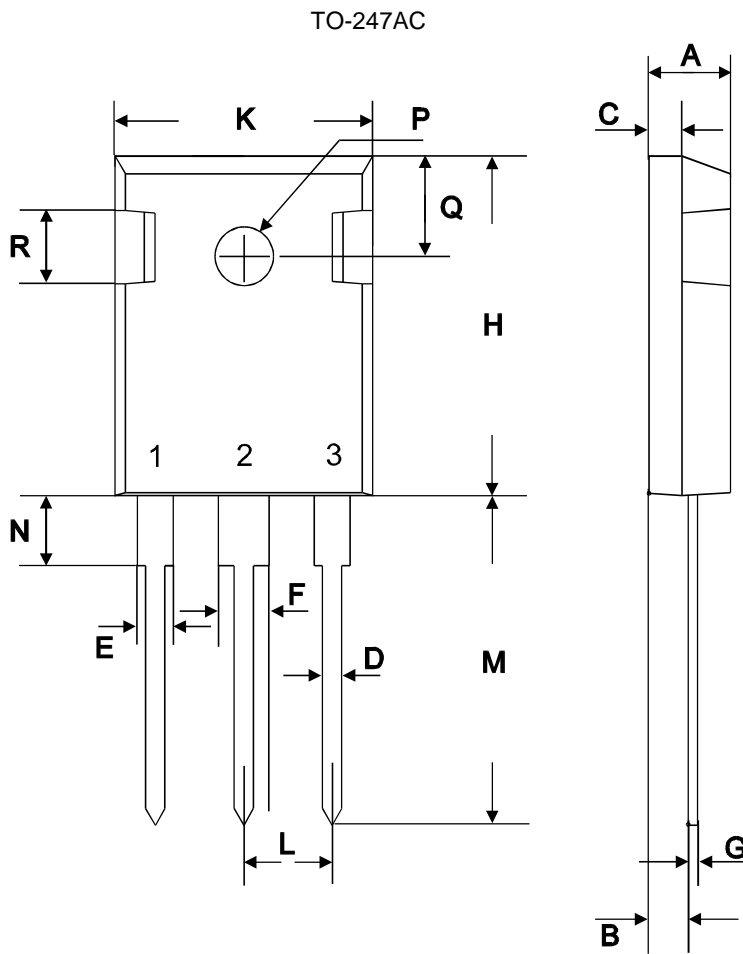

Figure 27. Diode transient thermal impedance as a function of pulse width ($D = t_p / T$)



symbol	dimensions			
	[mm]		[inch]	
	min	max	min	max
A	4.78	5.28	0.1882	0.2079
B	2.29	2.51	0.0902	0.0988
C	1.78	2.29	0.0701	0.0902
D	1.09	1.32	0.0429	0.0520
E	1.73	2.06	0.0681	0.0811
F	2.67	3.18	0.1051	0.1252
G	0.76 max		0.0299 max	
H	20.80	21.16	0.8189	0.8331
K	15.65	16.15	0.6161	0.6358
L	5.21	5.72	0.2051	0.2252
M	19.81	20.68	0.7799	0.8142
N	3.560	4.930	0.1402	0.1941
∅P	3.61		0.1421	
Q	6.12	6.22	0.2409	0.2449

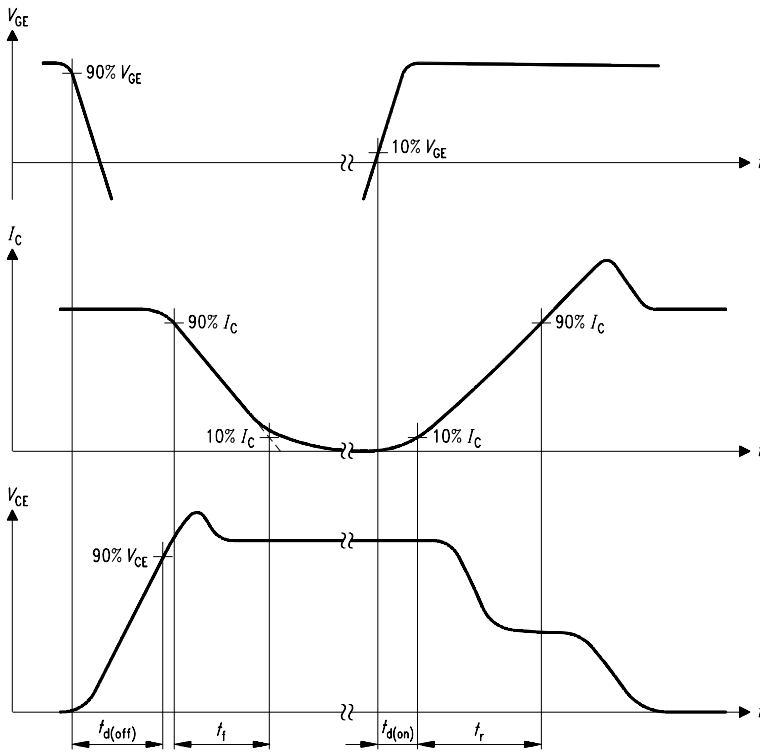

Figure A. Definition of switching times

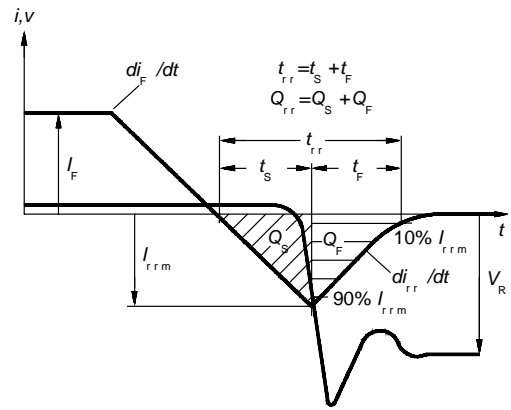

Figure C. Definition of diodes switching characteristics

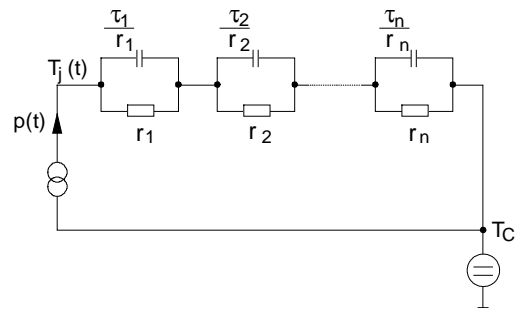

Figure D. Thermal equivalent circuit

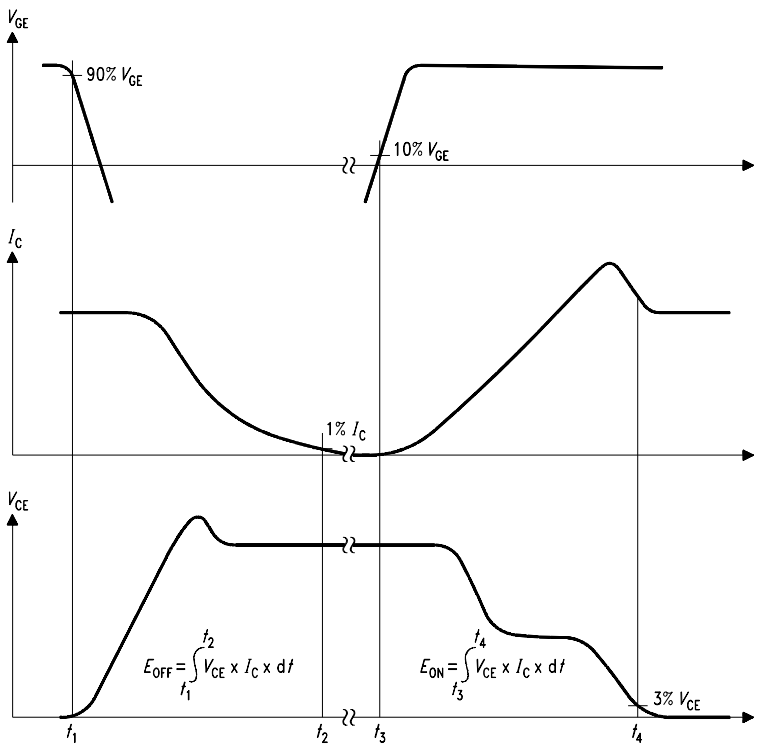

Figure B. Definition of switching losses

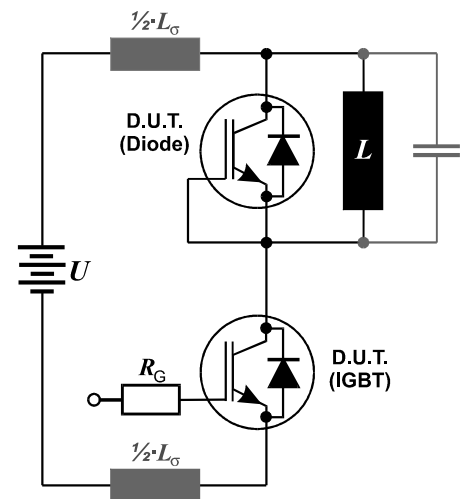

Figure E. Dynamic test circuit
Leakage inductance $L_{\sigma}=180\text{nH}$, and stray capacity $C_{\sigma}=40\text{pF}$.

Published by
Infineon Technologies AG i Gr.,
Bereich Kommunikation
St.-Martin-Strasse 53,
D-81541 München
© Infineon Technologies AG 1999
All Rights Reserved.

Attention please!

The information herein is given to describe certain components and shall not be considered as warranted characteristics.

Terms of delivery and rights to technical change reserved.

We hereby disclaim any and all warranties, including but not limited to warranties of non-infringement, regarding circuits, descriptions and charts stated herein.

Infineon Technologies is an approved CECC manufacturer.

Information

For further information on technology, delivery terms and conditions and prices please contact your nearest Infineon Technologies Office in Germany or our Infineon Technologies Representatives worldwide (see address list).

Warnings

Due to technical requirements components may contain dangerous substances. For information on the types in question please contact your nearest Infineon Technologies Office.

Infineon Technologies Components may only be used in life-support devices or systems with the express written approval of Infineon Technologies, if a failure of such components can reasonably be expected to cause the failure of that life-support device or system, or to affect the safety or effectiveness of that device or system. Life support devices or systems are intended to be implanted in the human body, or to support and/or maintain and sustain and/or protect human life. If they fail, it is reasonable to assume that the health of the user or other persons may be endangered.