

---

# HA13159

37 W × 4-Channel BTL Power IC

# HITACHI

ADE-207-264A (Z)

2nd Edition  
Jul. 1999

---

## Description

The HA13159 is four-channel BTL amplifier IC designed for car audio, featuring high output and low distortion, and applicable to digital audio equipment. It provides 37 W output per channel, with a 13.7 V power supply and at Max distortion.

## Functions

- 4 ch BTL power amplifiers
- Built-in standby circuit
- Built-in muting circuit
- Built-in protection circuit (surge, T.S.D and ASO)

## Features

- Low power dissipation
- Soft thermal limiter
- Requires few external parts (C:3, R:1)
- Popping noise minimized
- Low output noise
- Built-in high reliability protection circuit
- Pin to pin with HA13153A/HA13154A/HA13155/HA13157/HA13158/HA13158A

## Block Diagram

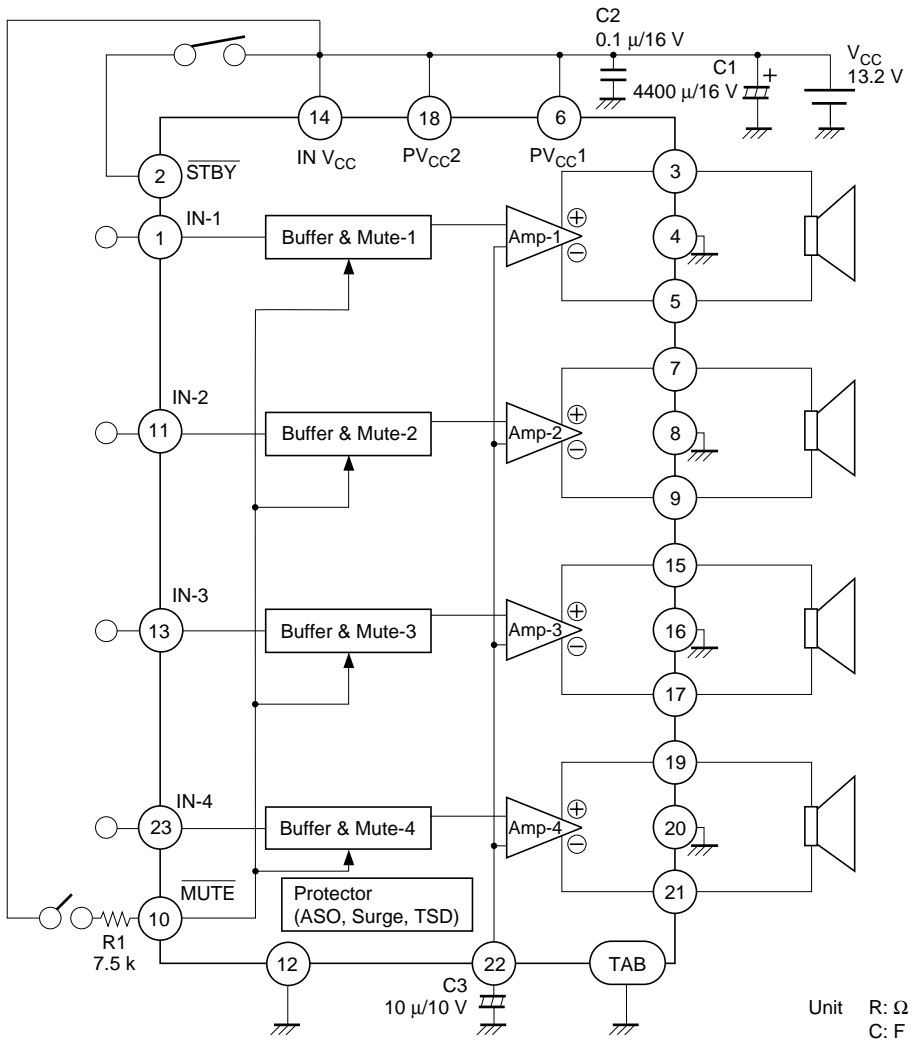

- Notes:
- Standby**  
Power is turned on when a signal of 3.5 V or 0.05 mA is impressed at pin 2. When pin 2 is open or connected to GND, standby is turned on (output off).
  - Muting**  
Muting is turned off (output on) when a signal of 3.5 V or 0.2 mA is impressed at pin 10. When pin 10 is open or connected to GND, muting is turned on (output off).
  - TAB** (header of IC) connected to GND.

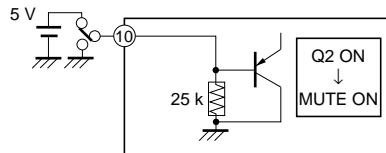
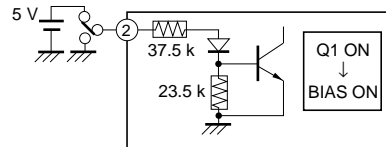

Unit R: Ω  
C: F

**Absolute Maximum Ratings**

Item	Symbol	Rating	Unit
Operating supply voltage	$V_{CC}$	18	V
Supply voltage when no signal*1	$V_{CC}$ (DC)	26	V
Peak supply voltage*2	$V_{CC}$ (PEAK)	50	V
Output current*3	$I_o$ (PEAK)	4	A
Power dissipation*4	$P_T$	83	W
Junction temperature	$T_j$	150	°C
Operating temperature	$T_{opr}$	-30 to +85	°C
Storage temperature	$T_{stg}$	-55 to +125	°C

- Note:
1. Tolerance within 30 seconds.
  2. Tolerance in surge pulse waveform.
  3. Value per 1 channel.
  4. Value when attached on the infinite heat sink plate at  $T_a = 25\text{ °C}$ .  
The derating curve is as shown in the graph below.

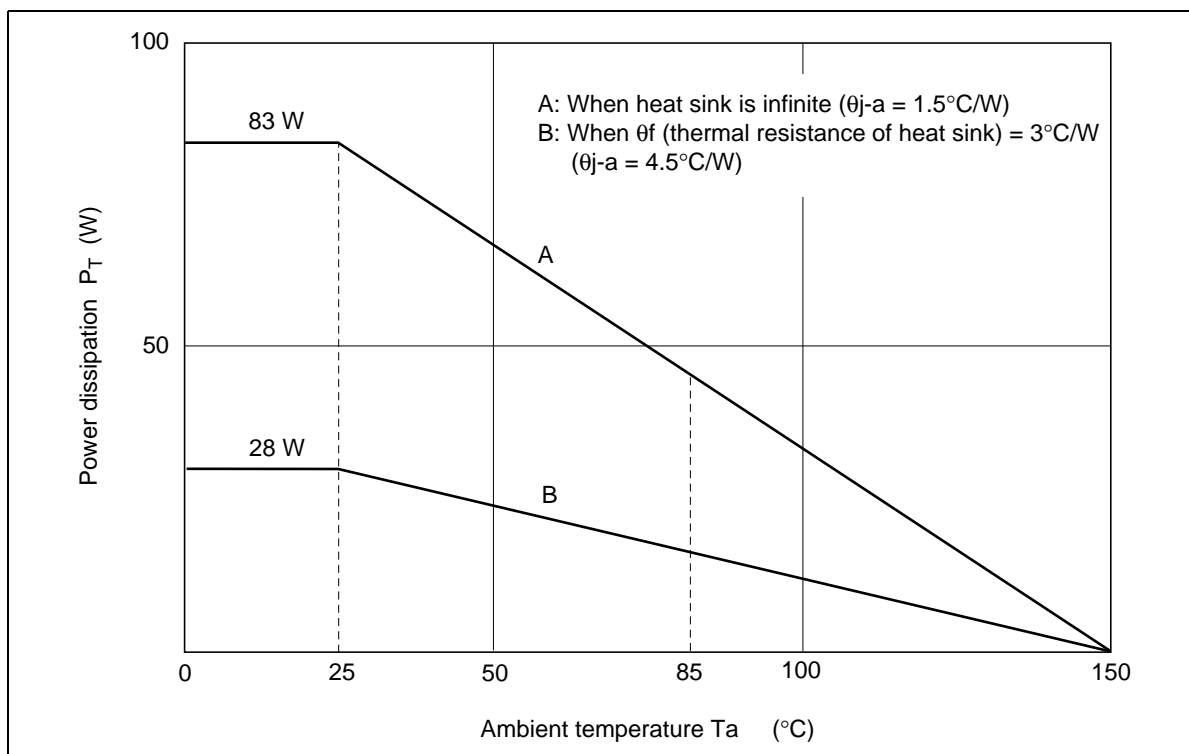

# HA13159

## Electrical Characteristics ( $V_{CC} = 13.2\text{ V}$ , $f = 1\text{ kHz}$ , $R_L = 4\ \Omega$ , $R_g = 600\ \Omega$ , $T_a = 25^\circ\text{C}$ )

Item	Symbol	Min	Typ	Max	Unit	Test Conditions
Quiescent current	$I_{Q1}$	—	220	—	mA	$V_{in} = 0$
Output offset voltage	$\Delta V_Q$	-180	0	+180	mV	
Gain	$G_V$	30.5	32	33.5	dB	
Gain difference between channels	$\Delta G_V$	-1.0	0	+1.0	dB	
Rated output power	$P_O$	—	22	—	W	$V_{CC} = 13.2\text{ V}$ , THD = 10%, $R_L = 4\ \Omega$
Max output power	$P_{OMAX}$	—	37	—	W	$V_{CC} = 13.7\text{ V}$ , $R_L = 4\ \Omega$
Total harmonic distortion	T.H.D.	—	0.03	—	%	$P_o = 3\text{ W}$
Output noise voltage	WBN	—	0.15	—	mVrms	$R_g = 0\ \Omega$ , BW = 20 to 20 kHz
Ripple rejection	SVR	—	55	—	dB	$f = 120\text{ Hz}$
Channel cross talk	C.T.	—	70	—	dB	$V_{out} = 0\text{ dBm}$
Input impedance	$R_{in}$	—	25	—	k $\Omega$	
Standby current	$I_{O2}$	—	—	10	$\mu\text{A}$	
Standby control voltage (high)	$V_{STH}$	3.5	—	$V_{CC}$	V	
Standby control voltage (low)	$V_{STL}$	0	—	1.5	V	
Muting control voltage (high)	$V_{MH}$	3.5	—	$V_{CC}$	V	
Muting control voltage (low)	$V_{ML}$	0	—	1.5	V	
Muting attenuation	ATTM	—	70	—	dB	$V_{out} = 0\text{ dBm}$

Pin Explanation

Pin No.	Symbol	Functions	Input Impedance	DC Voltage	Equivalence Circuit
1	IN1	CH1 INPUT	25 kΩ (Typ)	0 V	
11	IN2	CH2 INPUT			
13	IN3	CH3 INPUT			
23	IN4	CH4 INPUT			
2	STBY	Standby control	90 kΩ (at Trs. cutoff)	—	
3	OUT1 (+)	CH1 OUTPUT	—	V <sub>cc</sub> /2	
5	OUT1 (-)				
7	OUT2 (+)	CH2 OUTPUT			
9	OUT2 (-)				
15	OUT3 (+)	CH3 OUTPUT			
17	OUT3 (-)				
19	OUT4 (+)	CH4 OUTPUT			
21	OUT4 (-)				
10	MUTE	Muting control	25 kΩ (Typ)	—	
22	RIPPLE	Bias stability	—	V <sub>cc</sub> /2	

---

# HA13159

---

## Pin Explanation (cont)

Pin No.	Symbol	Functions	Input Impedance	DC Voltage	Equivalence Circuit
6	PV <sub>cc1</sub>	Power of output stage	—	V <sub>cc</sub>	—
18	PV <sub>cc2</sub>				
14	INV <sub>cc</sub>	Power of input stage	—	V <sub>cc</sub>	—
4	CH1 GND	CH1 power GND	—	—	—
8	CH2 GND	CH2 power GND			
16	CH3 GND	CH3 power GND			
20	CH4 GND	CH4 power GND			
12	IN GND	Input signal GND	—	—	—

## Point of Application Board Design

### 1. Notes on Application Board's Pattern Design

- For increasing stability, the connected line of  $V_{CC}$  and OUTGND is better to be made wider and lower impedance.
- For increasing stability, it is better to place the capacitor between  $V_{CC}$  and GND ( $0.1 \mu\text{F}$ ) close to IC.
- It is better to place the grounding of resistor ( $R_g$ ), between input line and ground, close to INGND (Pin 12) because if OUTGND is connected to the line between  $R_g$  and INGND, THD will become worse due to current from OUTGND.

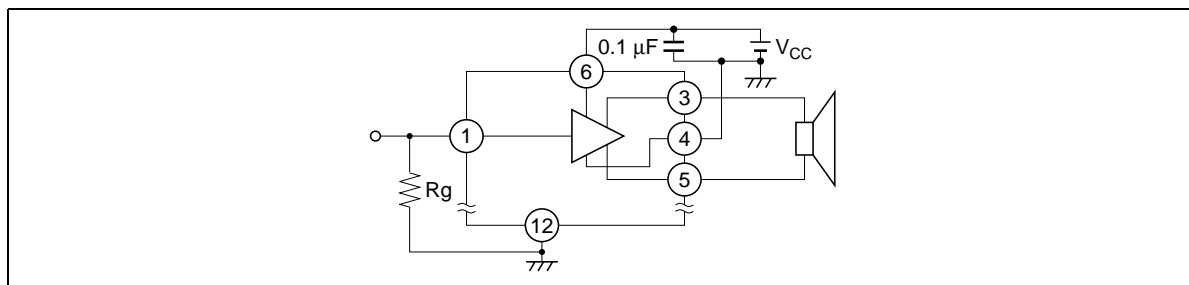

**Figure 1 Notes on Application Board's Pattern Design**

### 2. How to Reduce the Popping Noise by Muting Circuit

At normal operating circuit, Muting circuit operates at high speed under  $1 \mu\text{s}$ .

In case popping noise becomes a problem, it is possible to reduce the popping noise by connecting capacitor, which determines the switching time constant, between pin 10 and GND. (Following figure 2)

We recommend value of capacitor greater than  $1 \mu\text{F}$ .

Also transitional popping noise can be reduced sharply by muting before  $V_{CC}$  and Standby are ON/OFF.

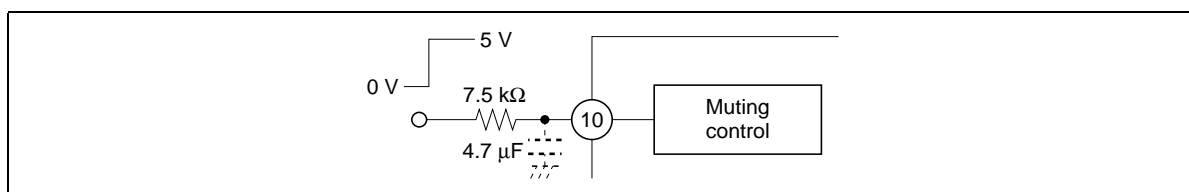
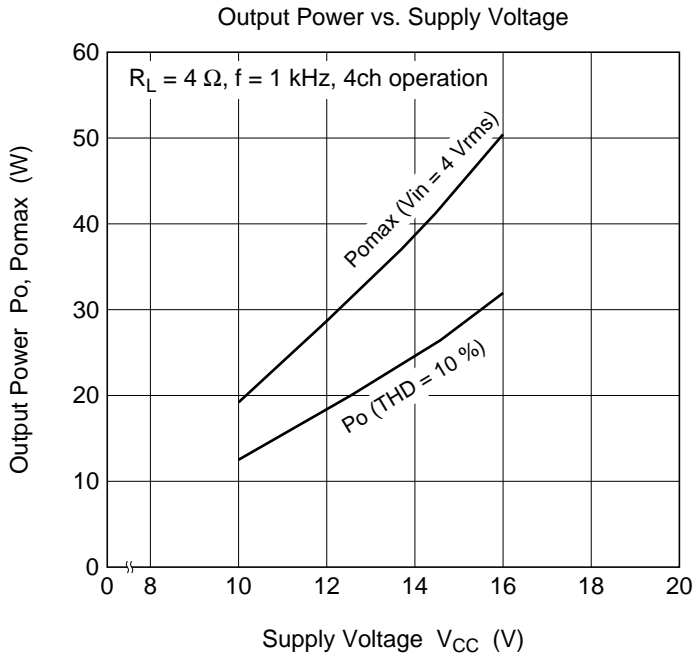
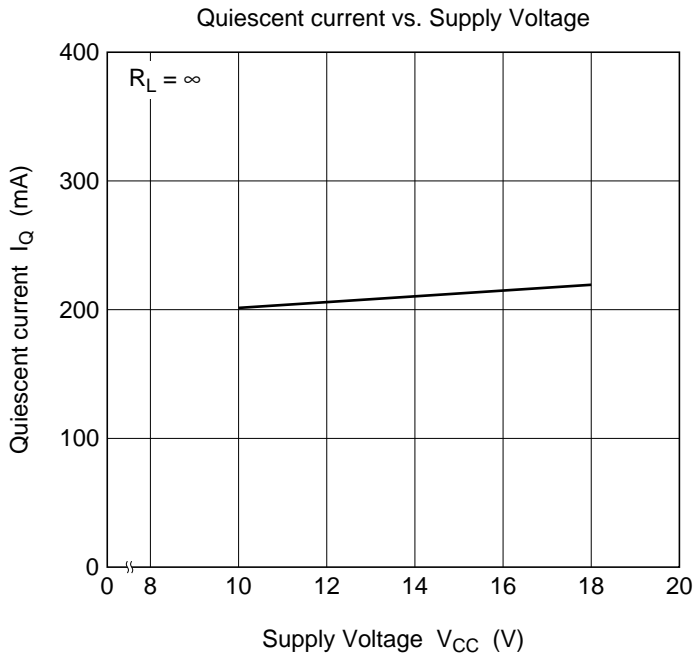

**Figure 2 How to use Muting Circuit**

**Table 1 Muting ON/OFF Time**

C ( $\mu\text{F}$ )	ON Time	OFF Time
nothing	under $1 \mu\text{s}$	under $1 \mu\text{s}$
0.47	2 ms	2 ms
4.7	19 ms	19 ms

## Characteristic Curves





Total Harmonic Distortion vs. Frequency

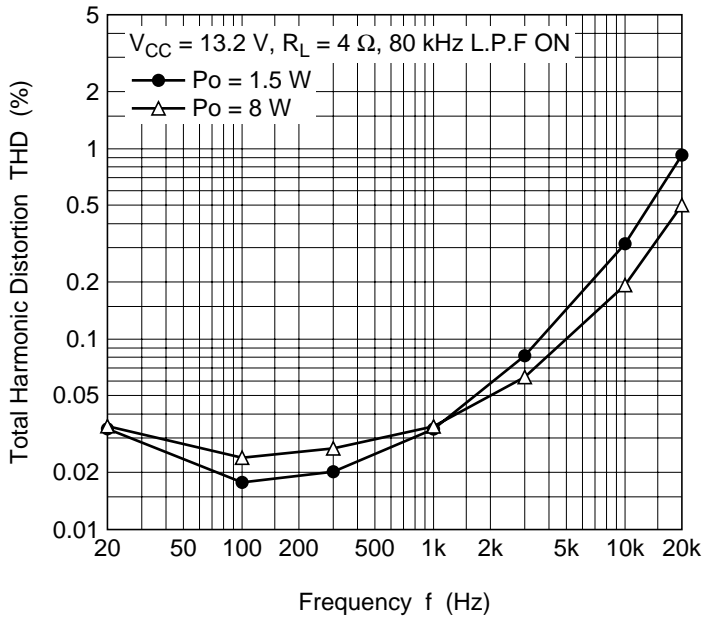

Total Harmonic Distortion vs. Output Power

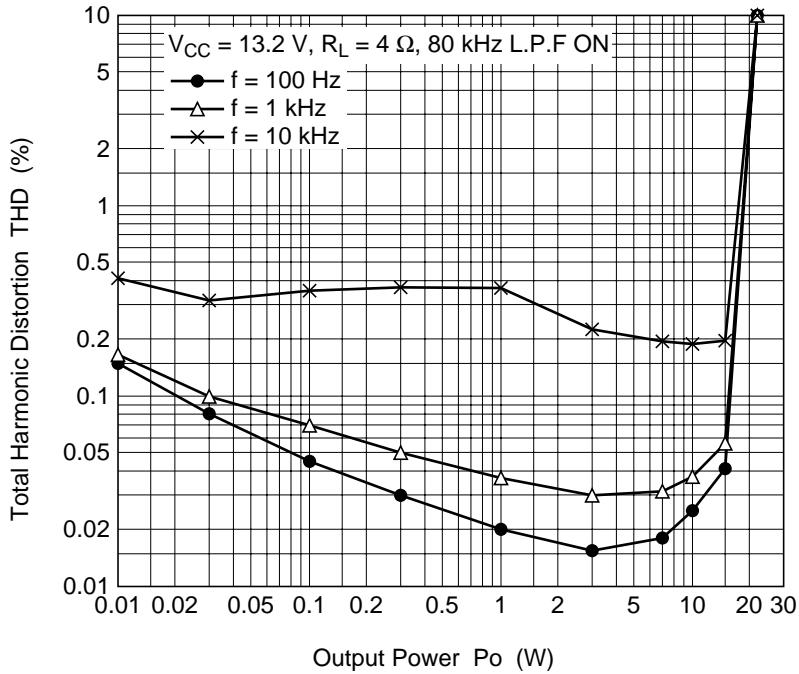

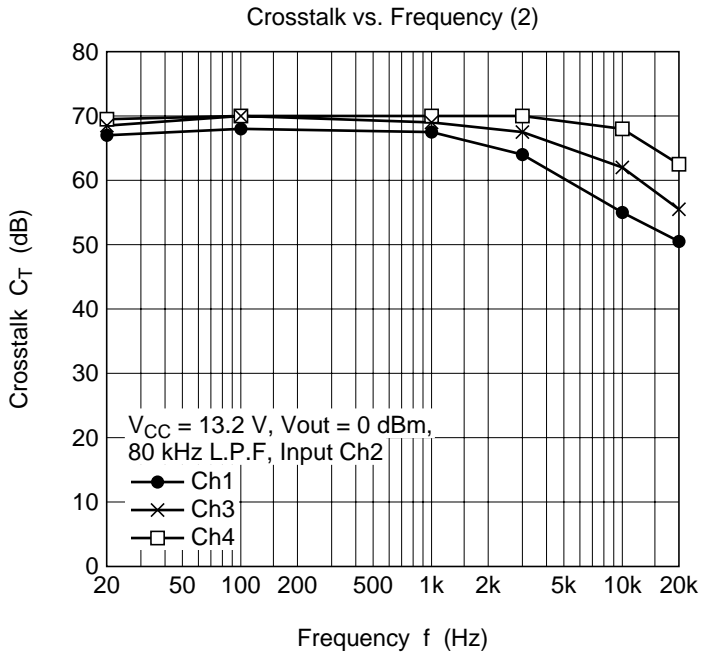
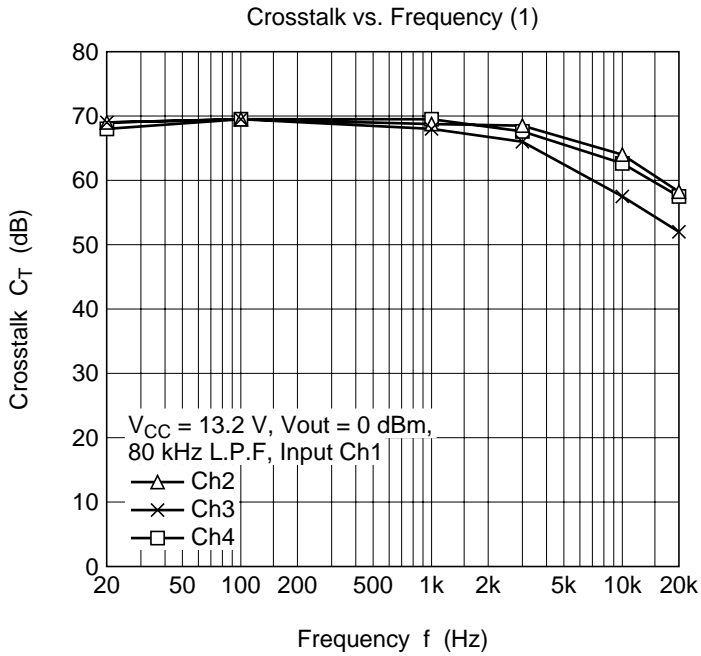

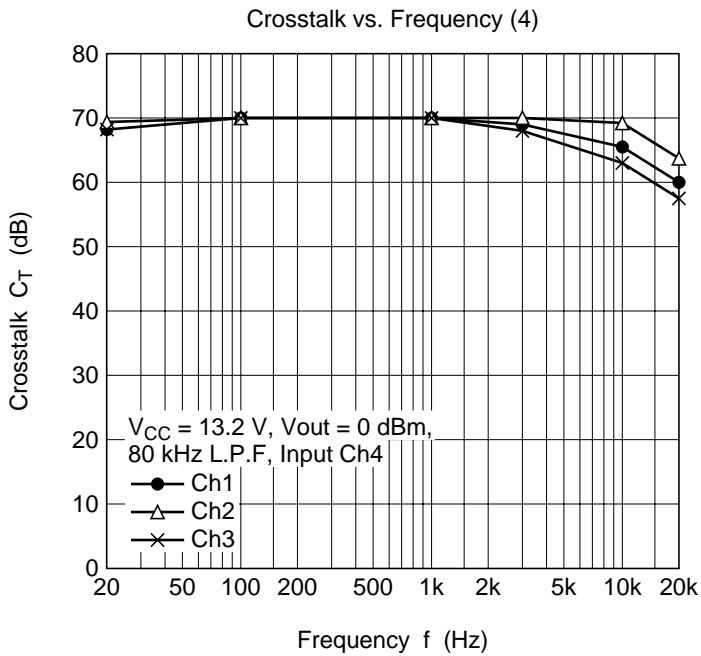
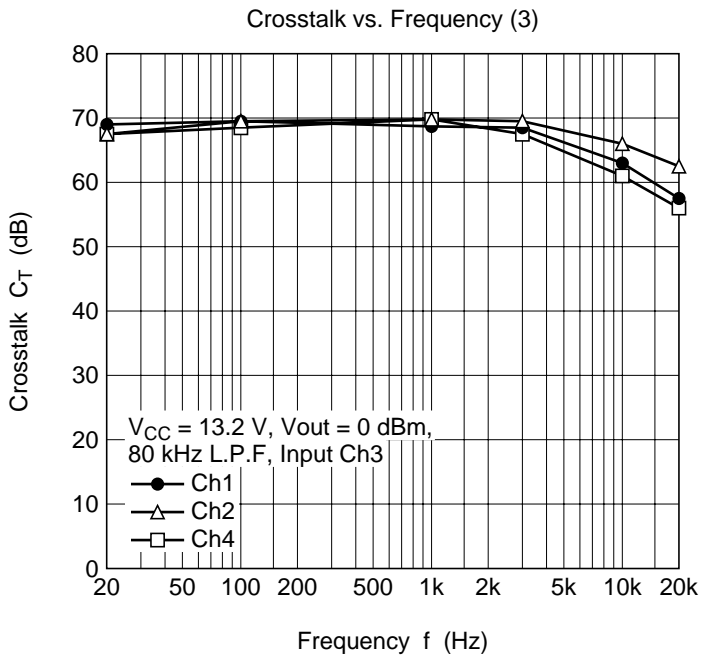

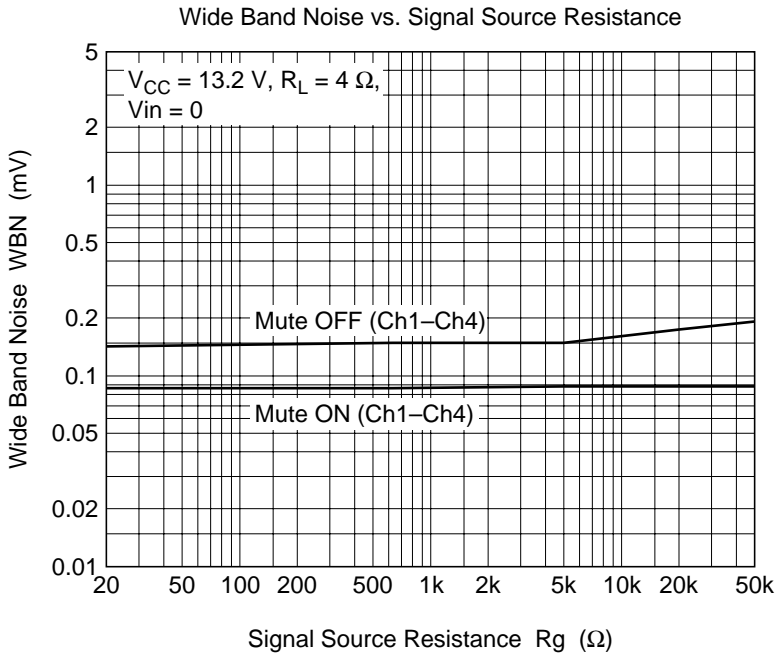
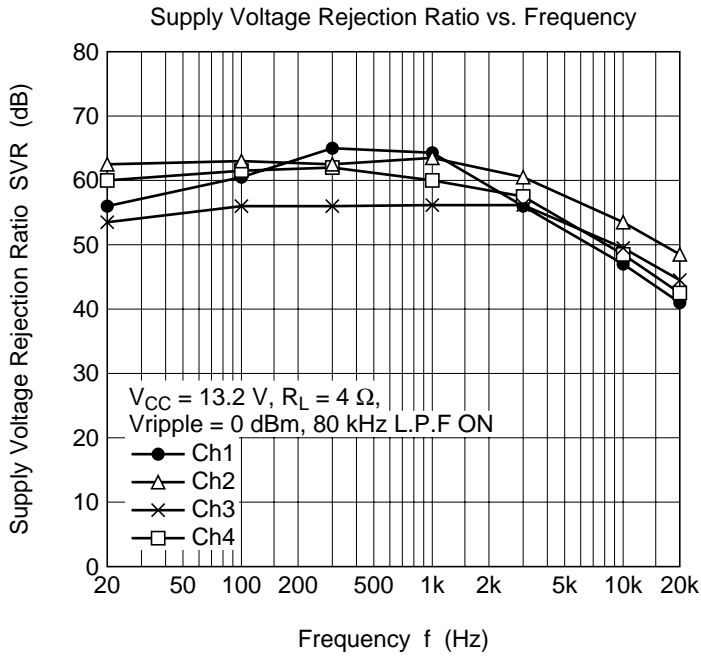

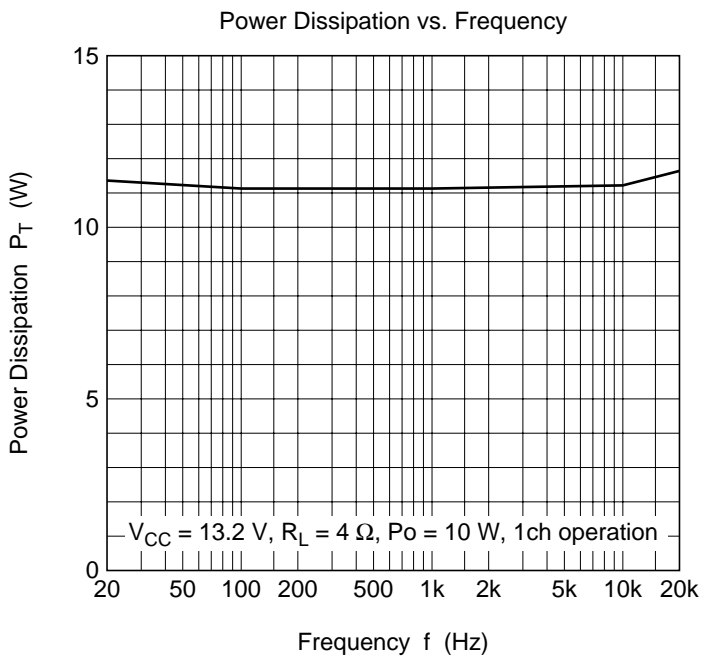
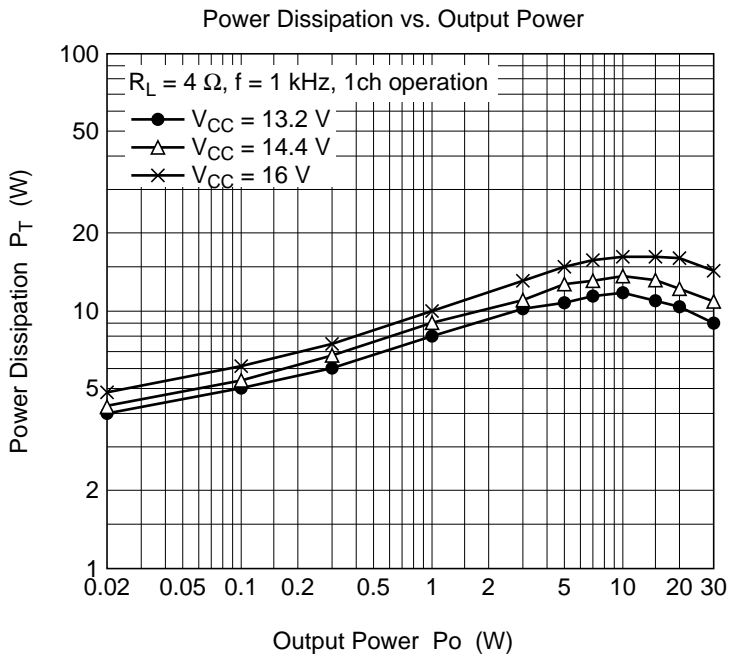

# HA13159

## Package Dimensions

Unit: mm

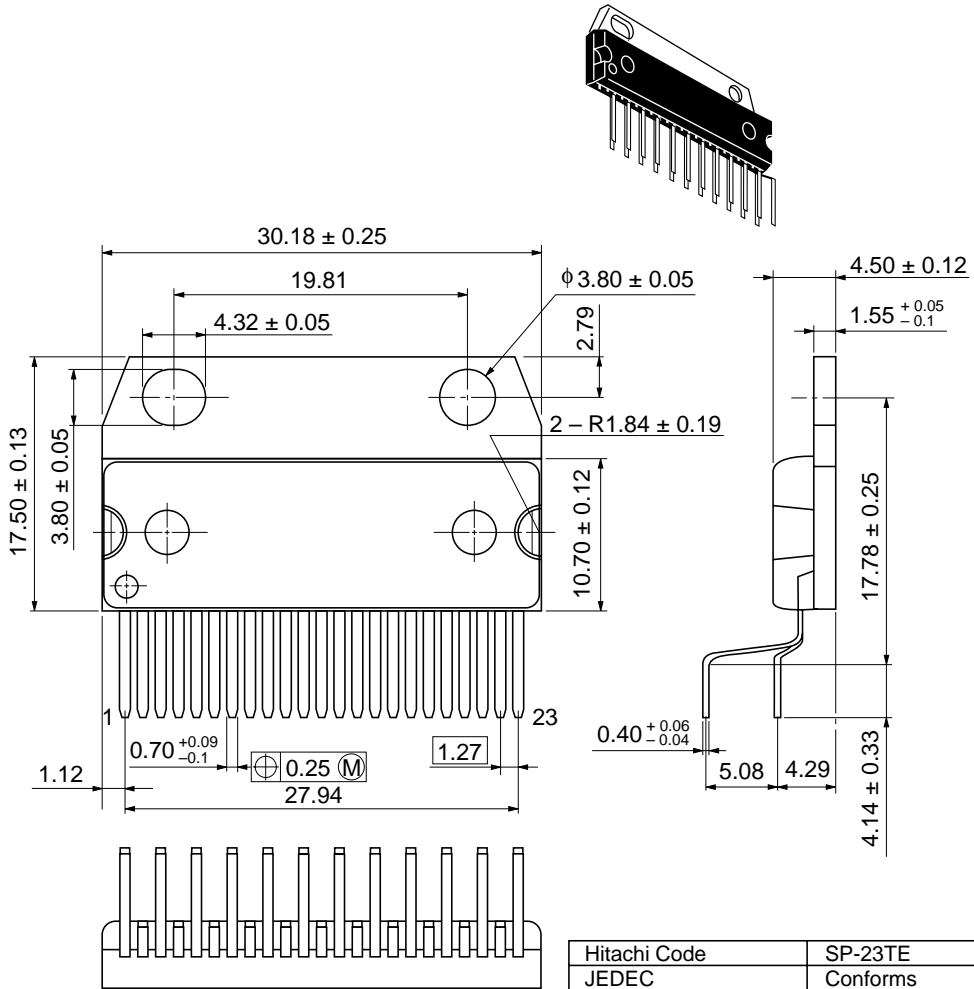

Hitachi Code	SP-23TE
JEDEC	Conforms
EIAJ	—
Weight (reference value)	8.5 g

**Disclaimer**

1. Hitachi neither warrants nor grants licenses of any rights of Hitachi's or any third party's patent, copyright, trademark, or other intellectual property rights for information contained in this document. Hitachi bears no responsibility for problems that may arise with third party's rights, including intellectual property rights, in connection with use of the information contained in this document.
2. Products and product specifications may be subject to change without notice. Confirm that you have received the latest product standards or specifications before final design, purchase or use.
3. Hitachi makes every attempt to ensure that its products are of high quality and reliability. However, contact Hitachi's sales office before using the product in an application that demands especially high quality and reliability or where its failure or malfunction may directly threaten human life or cause risk of bodily injury, such as aerospace, aeronautics, nuclear power, combustion control, transportation, traffic, safety equipment or medical equipment for life support.
4. Design your application so that the product is used within the ranges guaranteed by Hitachi particularly for maximum rating, operating supply voltage range, heat radiation characteristics, installation conditions and other characteristics. Hitachi bears no responsibility for failure or damage when used beyond the guaranteed ranges. Even within the guaranteed ranges, consider normally foreseeable failure rates or failure modes in semiconductor devices and employ systemic measures such as fail-safes, so that the equipment incorporating Hitachi product does not cause bodily injury, fire or other consequential damage due to operation of the Hitachi product.
5. This product is not designed to be radiation resistant.
6. No one is permitted to reproduce or duplicate, in any form, the whole or part of this document without written approval from Hitachi.
7. Contact Hitachi's sales office for any questions regarding this document or Hitachi semiconductor products.

**Sales Offices**

**HITACHI**

**Hitachi, Ltd.**

Semiconductor & Integrated Circuits.  
 Nippon Bldg., 2-6-2, Ohte-machi, Chiyoda-ku, Tokyo 100-0004, Japan  
 Tel: Tokyo (03) 3270-2111 Fax: (03) 3270-5109

URL           NorthAmerica       : <http://semiconductor.hitachi.com/>  
                   Europe                 : <http://www.hitachi-eu.com/hel/ecg>  
                   Asia                        : <http://sicapac.hitachi-asia.com>  
                   Japan                      : <http://www.hitachi.co.jp/Sicd/indx.htm>

**For further information write to:**

Hitachi Semiconductor  
 (America) Inc.  
 179 East Tasman Drive,  
 San Jose, CA 95134  
 Tel: <1>(408) 433-1990  
 Fax: <1>(408) 433-0223

Hitachi Europe GmbH  
 Electronic Components Group  
 Dornacher Straße 3  
 D-85622 Feldkirchen, Munich  
 Germany  
 Tel: <49> (89) 9 9180-0  
 Fax: <49> (89) 9 29 30 00  
  
 Hitachi Europe Ltd.  
 Electronic Components Group.  
 Whitebrook Park  
 Lower Cookham Road  
 Maidenhead  
 Berkshire SL6 8YA, United Kingdom  
 Tel: <44> (1628) 585000  
 Fax: <44> (1628) 585160

Hitachi Asia Ltd.  
 Hitachi Tower  
 16 Collyer Quay #20-00,  
 Singapore 049318  
 Tel : <65>-538-6533/538-8577  
 Fax : <65>-538-6933/538-3877  
 URL : <http://www.hitachi.com.sg>

Hitachi Asia Ltd.  
 (Taipei Branch Office)  
 4/F, No. 167, Tun Hwa North Road,  
 Hung-Kuo Building,  
 Taipei (105), Taiwan  
 Tel : <886>-(2)-2718-3666  
 Fax : <886>-(2)-2718-8180  
 Telex : 23222 HAS-TP  
 URL : <http://www.hitachi.com.tw>

Hitachi Asia (Hong Kong) Ltd.  
 Group III (Electronic Components)  
 7/F., North Tower,  
 World Finance Centre,  
 Harbour City, Canton Road  
 Tsim Sha Tsui, Kowloon,  
 Hong Kong  
 Tel : <852>-(2)-735-9218  
 Fax : <852>-(2)-730-0281  
 URL : <http://www.hitachi.com.hk>

Copyright © Hitachi, Ltd., 2000. All rights reserved. Printed in Japan.  
 Colophon 2.0