

## FDG6322C Dual N & P Channel Digital FET

### General Description

These dual N & P-Channel logic level enhancement mode field effect transistors are produced using Fairchild's proprietary, high cell density, DMOS technology. This very high density process is especially tailored to minimize on-state resistance. This device has been designed especially for low voltage applications as a replacement for bipolar digital transistors and small signal MOSFETs. Since bias resistors are not required, this dual digital FET can replace several different digital transistors, with different bias resistor values.

### Features

- N-Ch 0.22 A, 25 V,  $R_{DS(ON)} = 4.0 \Omega @ V_{GS} = 4.5 V$ ,  
 $R_{DS(ON)} = 5.0 \Omega @ V_{GS} = 2.7 V$ .
- P-Ch -0.41 A, -25V,  $R_{DS(ON)} = 1.1 \Omega @ V_{GS} = -4.5V$ ,  
 $R_{DS(ON)} = 1.5 \Omega @ V_{GS} = -2.7V$ .
- Very small package outline SC70-6.
- Very low level gate drive requirements allowing direct operation in 3 V circuits ( $V_{GS(th)} < 1.5 V$ ).
- Gate-Source Zener for ESD ruggedness (>6kV Human Body Model).

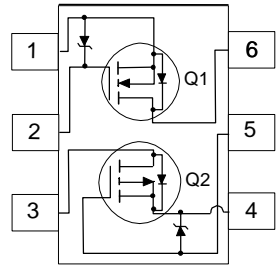
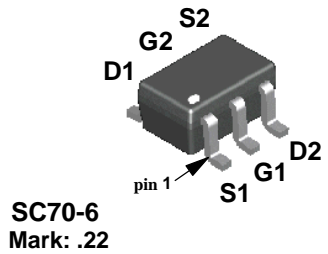
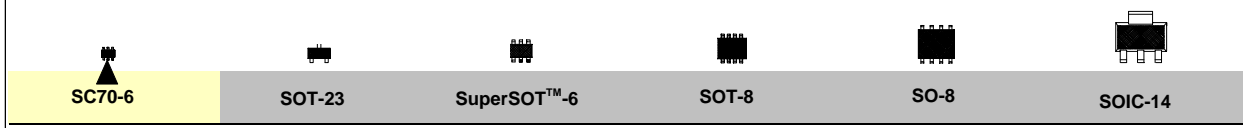

### Absolute Maximum Ratings $T_A = 25^\circ C$ unless other wise noted

Symbol	Parameter	N-Channel	P-Channel	Units
$V_{DSS}$	Drain-Source Voltage	25	-25	V
$V_{GSS}$	Gate-Source Voltage	8	-8	V
$I_D$	Drain Current - Continuous	0.22	-0.41	A
	- Pulsed	0.65	-1.2	
$P_D$	Maximum Power Dissipation (Note 1)	0.3		W
$T_J, T_{STG}$	Operating and Storage Temperature Range	-55 to 150		$^\circ C$
ESD	Electrostatic Discharge Rating MIL-STD-883D Human Body Model (100pf / 1500 Ohm)	6		kV

### THERMAL CHARACTERISTICS

$R_{\theta JA}$	Thermal Resistance, Junction-to-Ambient (Note1)	415	$^\circ C/W$
-----------------	---	-----	--------------

**DMOS Electrical Characteristics** ( $T_A = 25\text{ }^\circ\text{C}$  unless otherwise noted)

Symbol	Parameter	Conditions	Type	Min	Typ	Max	Units
<b>OFF CHARACTERISTICS</b>							
$BV_{DSS}$	Drain-Source Breakdown Voltage	$V_{GS} = 0\text{ V}, I_D = 250\text{ }\mu\text{A}$	N-Ch	25			V
		$V_{GS} = 0\text{ V}, I_D = -250\text{ }\mu\text{A}$	P-Ch	-25			
$\Delta BV_{DSS}/\Delta T_J$	Breakdown Voltage Temp. Coefficient	$I_D = 250\text{ }\mu\text{A}$ , Referenced to $25\text{ }^\circ\text{C}$	N-Ch		25		mV/ $^\circ\text{C}$
		$I_D = -250\text{ }\mu\text{A}$ , Referenced to $25\text{ }^\circ\text{C}$	P-Ch		-22		
$I_{DSS}$	Zero Gate Voltage Drain Current	$V_{DS} = 20\text{ V}, V_{GS} = 0\text{ V}$ , $T_J = 55\text{ }^\circ\text{C}$	N-Ch			1 10	$\mu\text{A}$
		$V_{DS} = -20\text{ V}, V_{GS} = 0\text{ V}$ , $T_J = 55\text{ }^\circ\text{C}$	P-Ch			-1 -10	
$I_{GSS}$	Gate - Body Leakage Current	$V_{GS} = 8\text{ V}, V_{DS} = 0\text{ V}$	N-Ch			100	nA
		$V_{GS} = -8\text{ V}, V_{DS} = 0\text{ V}$	P-Ch			-100	nA
<b>ON CHARACTERISTICS</b> (Note 2)							
$V_{GS(th)}$	Gate Threshold Voltage	$V_{DS} = V_{GS}, I_D = 250\text{ }\mu\text{A}$	N-Ch	0.65	0.85	1.5	V
		$V_{DS} = V_{GS}, I_D = -250\text{ }\mu\text{A}$	P-Ch	-0.65	-0.82	-1.5	
$\Delta V_{GS(th)}/\Delta T_J$	Gate Threshold Voltage Temp. Coefficient	$I_D = 250\text{ }\mu\text{A}$ , Referenced to $25\text{ }^\circ\text{C}$	N-Ch		-2.1		mV/ $^\circ\text{C}$
		$I_D = -250\text{ }\mu\text{A}$ , Referenced to $25\text{ }^\circ\text{C}$	P-Ch		2.1		
$R_{DS(on)}$	Static Drain-Source On-Resistance	$V_{GS} = 4.5\text{ V}, I_D = 0.22\text{ A}$ , $T_J = 125\text{ }^\circ\text{C}$	N-Ch		2.6	4	$\Omega$
		$V_{GS} = 2.7\text{ V}, I_D = 0.19\text{ A}$			5.3	7	
		$V_{GS} = -4.5\text{ V}, I_D = -0.41\text{ A}$ , $T_J = 125\text{ }^\circ\text{C}$		P-Ch		0.85	
		$V_{GS} = -2.7\text{ V}, I_D = -0.25\text{ A}$			1.2	1.9	
					1.15	1.5	
$I_{D(on)}$	On-State Drain Current	$V_{GS} = 4.5\text{ V}, V_{DS} = 5\text{ V}$	N-Ch	0.22			A
		$V_{GS} = -4.5\text{ V}, V_{DS} = -5\text{ V}$	P-Ch	-0.41			
$g_{FS}$	Forward Transconductance	$V_{DS} = 5\text{ V}, I_D = 0.22\text{ A}$	N-Ch		0.2		S
		$V_{DS} = -5\text{ V}, I_D = -0.5\text{ A}$	P-Ch		0.9		
<b>DYNAMIC CHARACTERISTICS</b>							
$C_{iss}$	Input Capacitance	N-Channel $V_{DS} = 10\text{ V}, V_{GS} = 0\text{ V}$	N-Ch		9.5		pF
			P-Ch		62		
$C_{oss}$	Output Capacitance	f = 1.0 MHz P-Channel	N-Ch		6		
			P-Ch		34		
$C_{rss}$	Reverse Transfer Capacitance	$V_{DS} = -10\text{ V}, V_{GS} = 0\text{ V}$ , f = 1.0 MHz	N-Ch		1.3		
			P-Ch		10		

## Electrical Characteristics (continued)

### SWITCHING CHARACTERISTICS (Note 2)

Symbol	Parameter	Conditions	Type	Min	Typ	Max	Units
$t_{D(on)}$	Turn - On Delay Time	N-Channel $V_{DD} = 5\text{ V}, I_D = 0.5\text{ A},$	N-Ch		5	10	nS
			P-Ch		7	15	
$t_r$	Turn - On Rise Time	$V_{GS} = 4.5\text{ V}, R_{GEN} = 50\ \Omega$	N-Ch		4.5	10	nS
			P-Ch		8	16	
$t_{D(off)}$	Turn - Off Delay Time	P-Channel $V_{DD} = -5\text{ V}, I_D = -0.5\text{ A},$	N-Ch		4	8	nS
			P-Ch		55	80	
$t_f$	Turn - Off Fall Time	$V_{GS} = -4.5\text{ V}, R_{GEN} = 50\ \Omega$	N-Ch		3.2	7	nS
			P-Ch		35	60	
$Q_g$	Total Gate Charge	N-Channel $V_{DS} = 5\text{ V}, I_D = 0.22\text{ A},$	N-Ch		0.29	0.4	nC
			P-Ch		1.1	1.5	
$Q_{gs}$	Gate-Source Charge	$V_{GS} = 4.5\text{ V}$	N-Ch		0.12		nC
			P-Ch		0.31		
$Q_{gd}$	Gate-Drain Charge	P-Channel $V_{DS} = -5\text{ V}, I_D = -0.41\text{ A},$ $V_{GS} = -4.5\text{ V}$	N-Ch		0.03		nC
			P-Ch		0.29		

### DRAIN-SOURCE DIODE CHARACTERISTICS AND MAXIMUM RATINGS

$I_S$	Maximum Continuous Drain-Source Diode Forward Current		N-Ch			0.25	A
			P-Ch			-0.25	
$V_{SD}$	Drain-Source Diode Forward Voltage	$V_{GS} = 0\text{ V}, I_S = 0.5\text{ A}$ (Note 2)	N-Ch		0.8	1.2	V
		$V_{GS} = 0\text{ V}, I_S = -0.5\text{ A}$ (Note 2)	P-Ch		-0.85	-1.2	

Notes:

- $R_{\theta JA}$  is the sum of the junction-to-case and case-to-ambient thermal resistance where the case thermal reference is defined as the solder mounting surface of the drain pins.  $R_{\theta JC}$  is guaranteed by design while  $R_{\theta CA}$  is determined by the user's board design.  $R_{\theta JA} = 415^\circ\text{C/W}$  on minimum mounting pad on FR-4 board in still air.
- Pulse Test: Pulse Width  $\leq 300\ \mu\text{s}$ , Duty Cycle  $\leq 2.0\%$ .

## Typical Electrical Characteristics: N-Channel

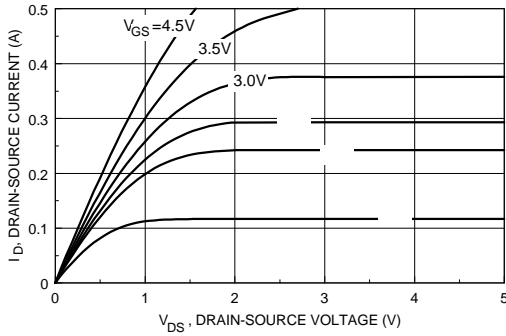

Figure 1. On-Region Characteristics.

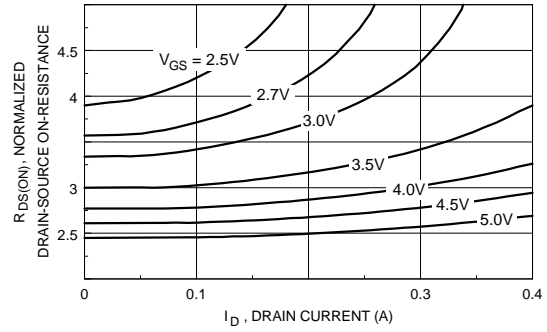

Figure 2. On-Resistance Variation with Drain Current and Gate Voltage.

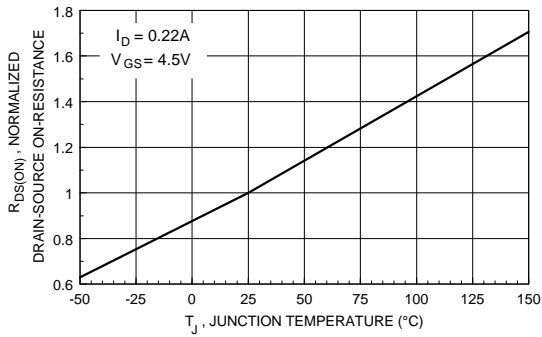

Figure 3. On-Resistance Variation with Temperature.

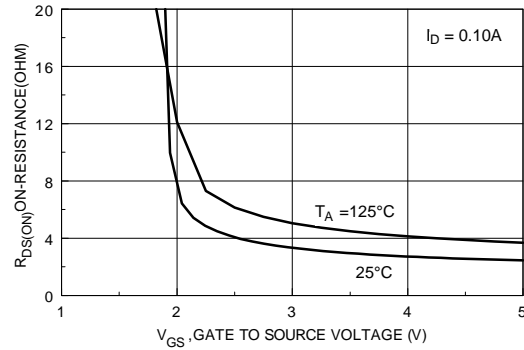

Figure 4. On-Resistance Variation with Gate-to-Source Voltage.

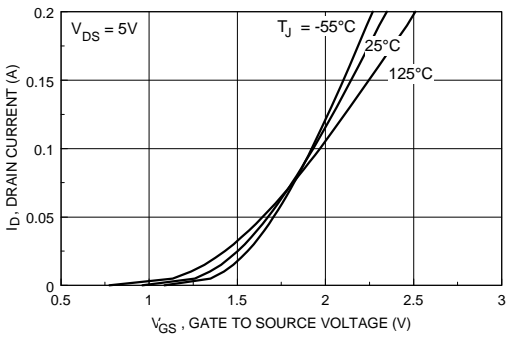

Figure 5. Transfer Characteristics.

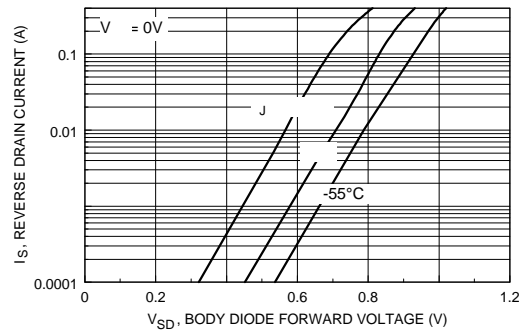

Figure 6. Voltage with Source Current and Temperature.

## Typical Electrical Characteristics: N-Channel (continued)

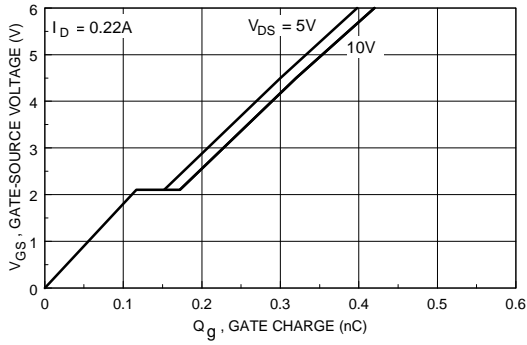

Figure 7. Gate Charge Characteristics.

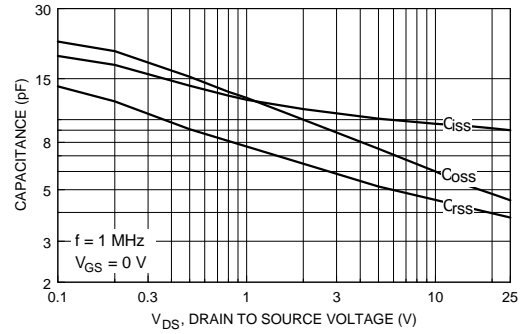

Figure 8. Capacitance Characteristics.

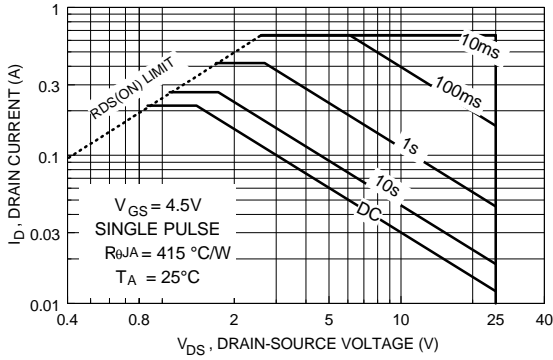

Figure 9. Maximum Safe Operating Area.

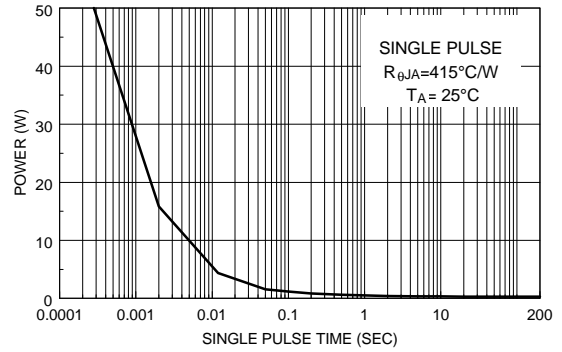

Figure 10. Single Pulse Maximum Power Dissipation.

## Typical Electrical Characteristics: P-Channel

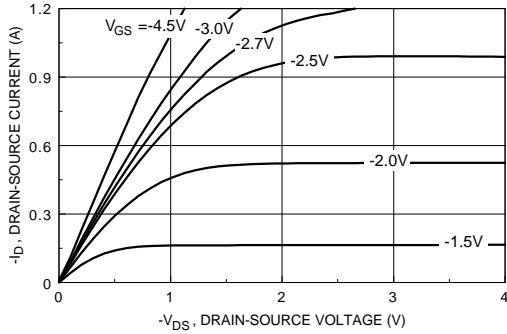

Figure 11. On-Region Characteristics.

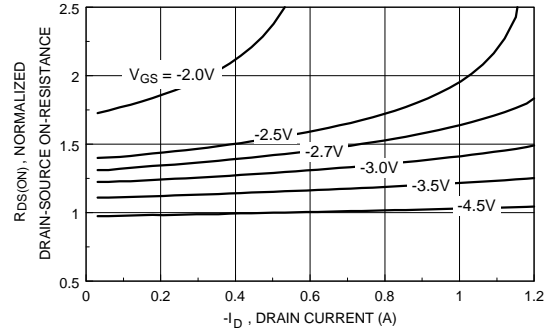

Figure 12. On-Resistance Variation with Drain Current and Gate Voltage.

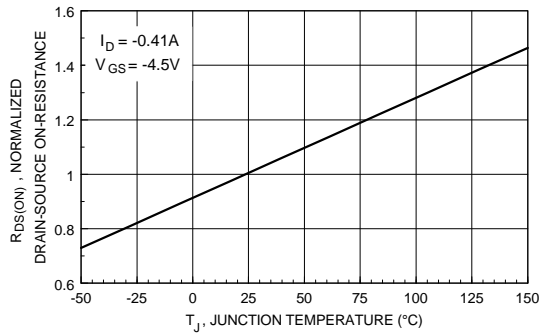

Figure 13. On-Resistance Variation with Temperature.

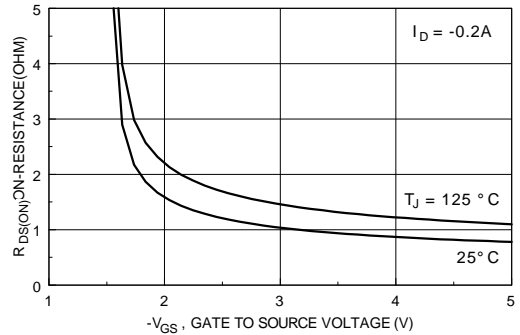

Figure 14. On-Resistance Variation with Gate-to-Source Voltage.

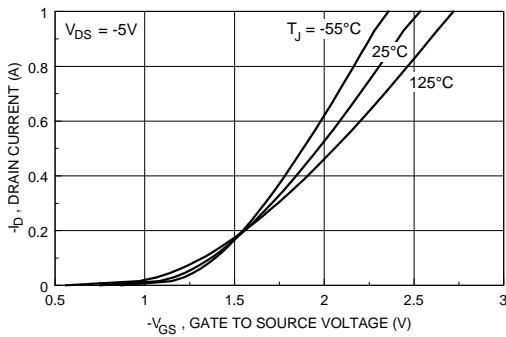

Figure 15. Transfer Characteristics.

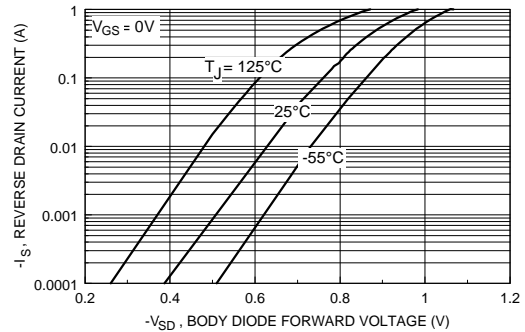

Figure 16. Body Diode Forward Voltage Variation with Source Current and Temperature.

## Typical Electrical Characteristics: P-Channel (continued)

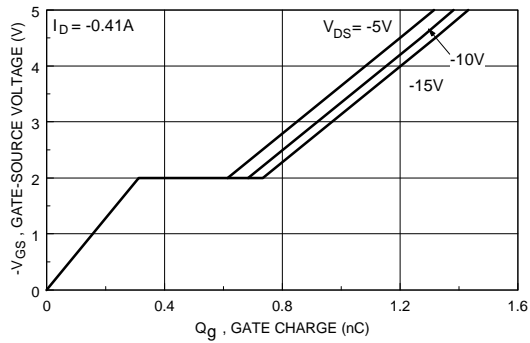

Figure 17. Gate Charge Characteristics.

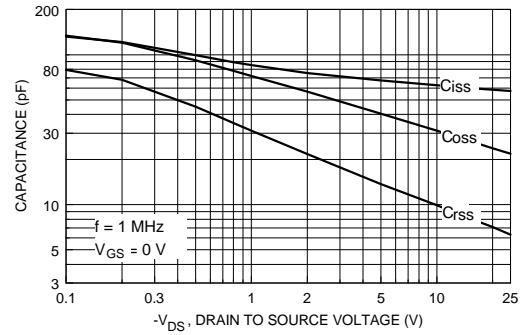

Figure 18. Capacitance Characteristics.

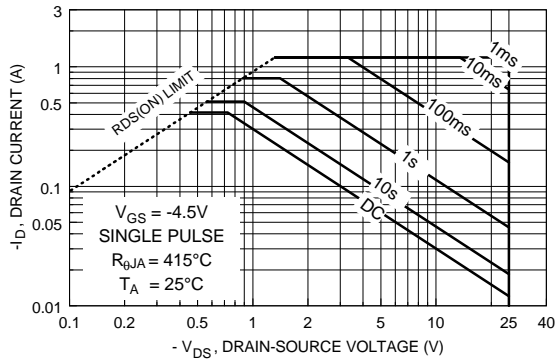

Figure 19. Maximum Safe Operating Area.

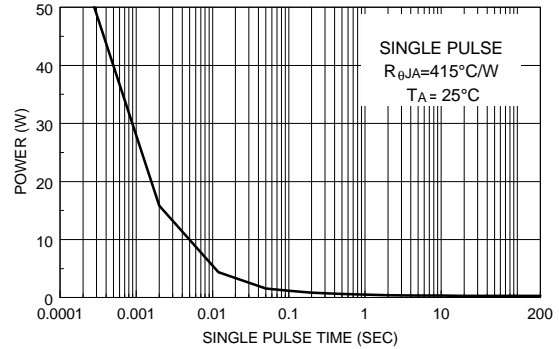
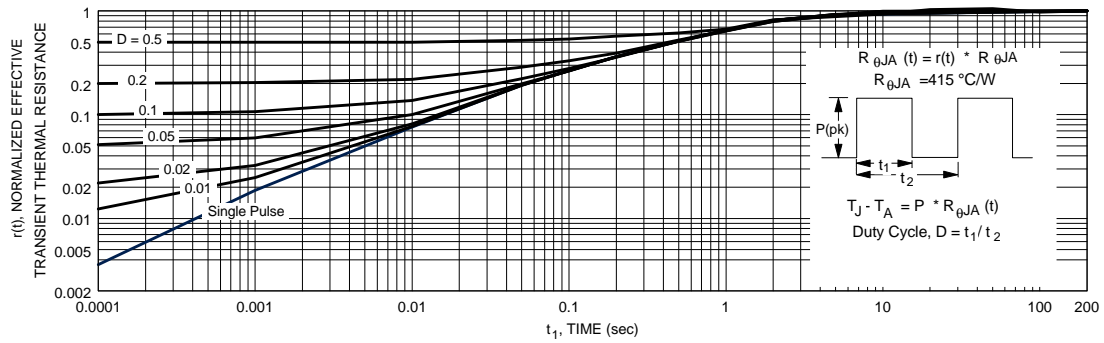

Figure 20. Single Pulse Maximum Power Dissipation.

## Typical Thermal Characteristics: N & P-Channel (continued)



**Figure 21. Transient Thermal Response Curve.**

Thermal characterization performed using the conditions described in note 1.  
 Transient thermal response will change depending on the circuit board design.



# SC70-6 Tape and Reel Data and Package Dimensions



## SC70-6 Packaging Configuration: Figure 1.0

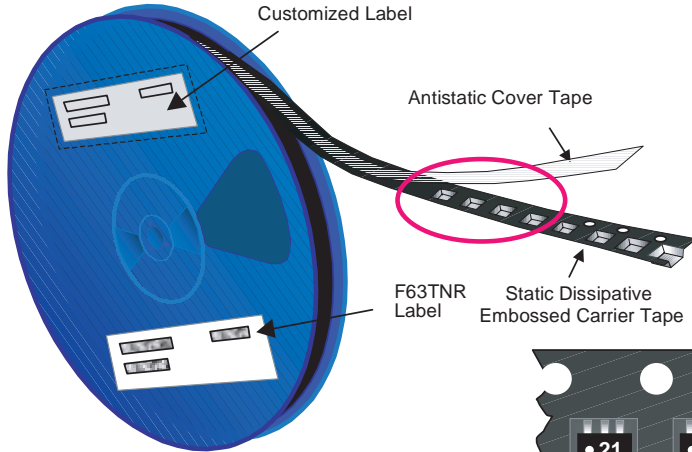

### Packaging Description:

SC70-6 parts are shipped in tape. The carrier tape is made from a dissipative (carbon filled) polycarbonate resin. The cover tape is a multilayer film (Heat Activated Adhesive in nature) primarily composed of polyester film, adhesive layer, sealant, and anti-static sprayed agent. These reeled parts in standard option are shipped with 3,000 units per 7" or 177cm diameter reel. The reels are dark blue in color and is made of polystyrene plastic (anti-static coated). Other option comes in 10,000 units per 13" or 330cm diameter reel. This and some other options are described in the Packaging Information table.

These full reels are individually barcode labeled and placed inside a pizza box (illustrated in figure 1.0) made of recyclable corrugated brown paper with a Fairchild logo printing. One pizza box contains three reels maximum. And these pizza boxes are placed inside a barcode labeled shipping box which comes in different sizes depending on the number of parts shipped.

SC70-6 Packaging Information		
Packaging Option	Standard (no flow code)	D87Z
Packaging type	TNR	TNR
Qty per Reel/Tube/Bag	3,000	10,000
Reel Size	7" Dia	13"
Box Dimension (mm)	184x187x47	343x343x64
Max qty per Box	9,000	30,000
Weight per unit (gm)	0.0055	0.0055
Weight per Reel (kg)	0.1140	0.3960
Note/Comments		

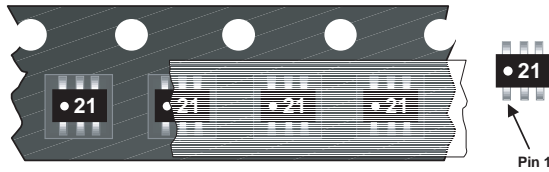

### SC70-6 Unit Orientation

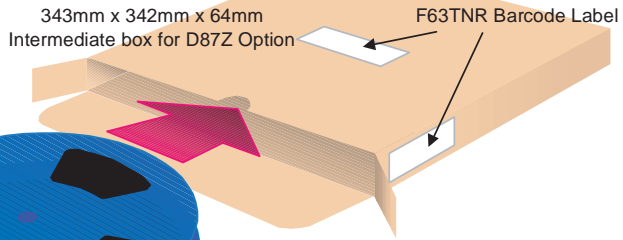
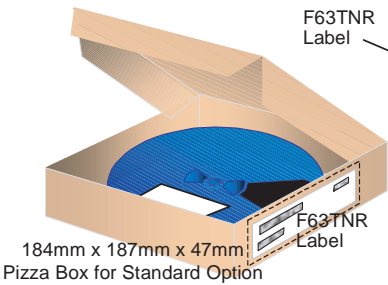

### F63TNR Label sample



## SC70-6 Tape Leader and Trailer Configuration: Figure 2.0

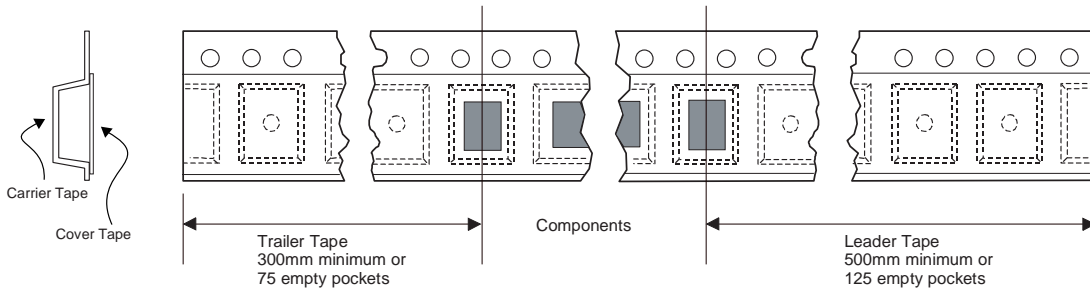

# SC70-6 Tape and Reel Data and Package Dimensions, continued

## SC70-6 Embossed Carrier Tape Configuration: Figure 3.0

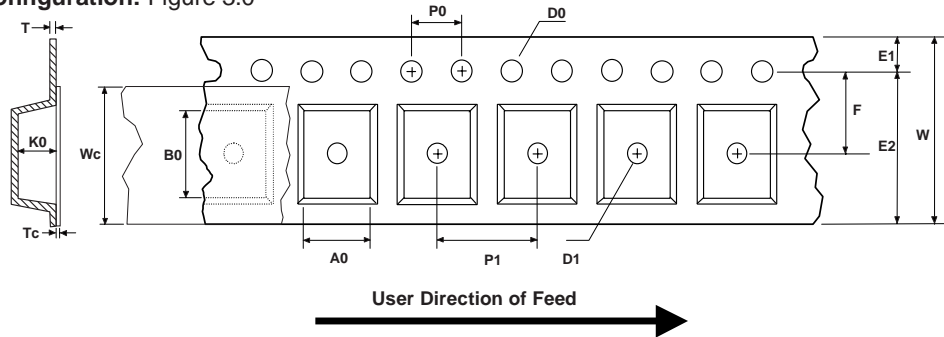

Dimensions are in millimeter														
Pkg type	A0	B0	W	D0	D1	E1	E2	F	P1	P0	K0	T	Wc	Tc
SC70-6 (8mm)	2.24 +/-0.10	2.34 +/-0.10	8.0 +/-0.3	1.55 +/-0.05	1.125 +/-0.125	1.75 +/-0.10	6.25 min	3.50 +/-0.05	4.0 +/-0.1	4.0 +/-0.1	1.20 +/-0.10	0.255 +/-0.150	5.2 +/-0.3	0.06 +/-0.02

Notes: A0, B0, and K0 dimensions are determined with respect to the EIA/Jedec RS-481 rotational and lateral movement requirements (see sketches A, B, and C).

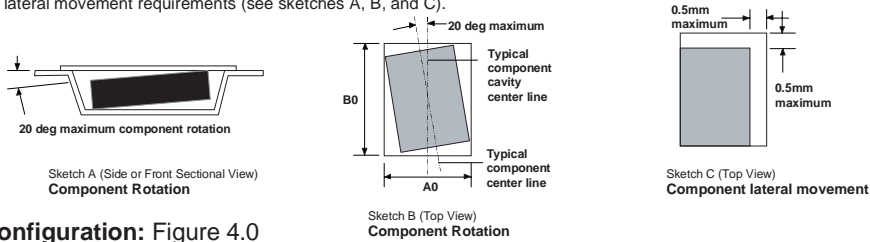

## SC70-6 Reel Configuration: Figure 4.0

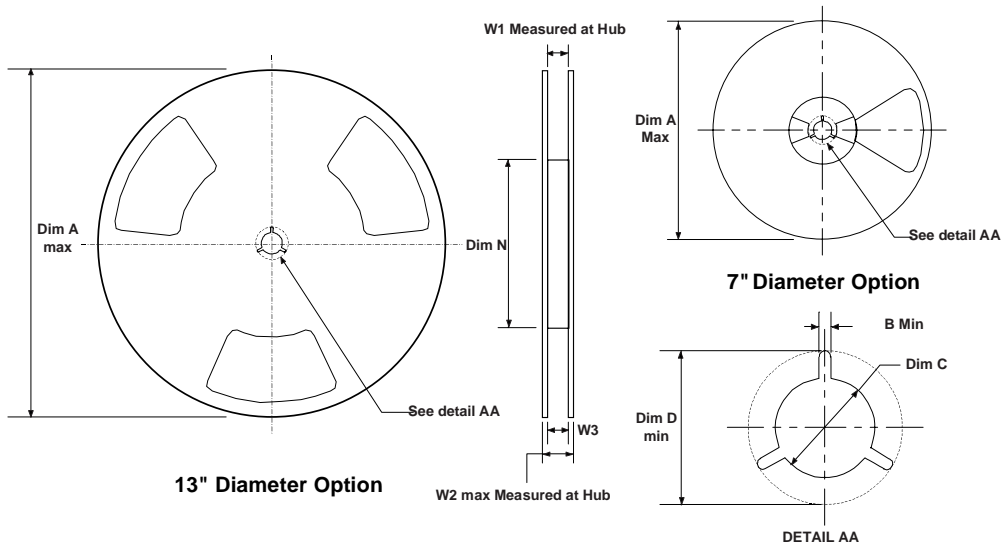

Dimensions are in inches and millimeters									
Tape Size	Reel Option	Dim A	Dim B	Dim C	Dim D	Dim N	Dim W1	Dim W2	Dim W3 (LSL-USL)
8mm	7" Dia	7.00 177.8	0.059 1.5	0.512 +0.020/-0.008 13 +0.5/-0.2	0.795 20.2	2.165 55	0.331 +0.059/-0.000 8.4 +1.5/0	0.567 14.4	0.311 - 0.429 7.9 - 10.9
8mm	13" Dia	13.00 330	0.059 1.5	0.512 +0.020/-0.008 13 +0.5/-0.2	0.795 20.2	4.00 100	0.331 +0.059/-0.000 8.4 +1.5/0	0.567 14.4	0.311 - 0.429 7.9 - 10.9

**SC70-6 Tape and Reel Data and Package Dimensions, continued**

**SC70-6 (FS PKG Code 76)**

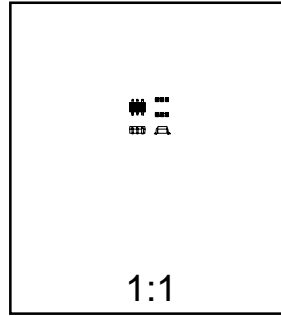
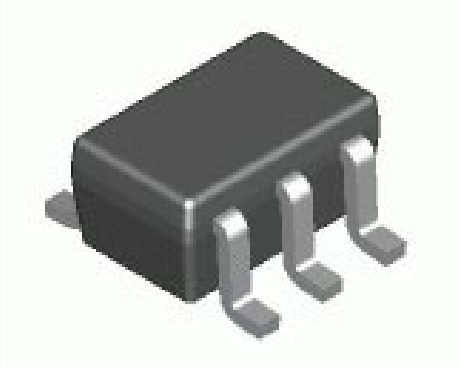

Scale 1:1 on letter size paper

Dimensions shown below are in:  
inches [millimeters]

Part Weight per unit (gram): 0.0055

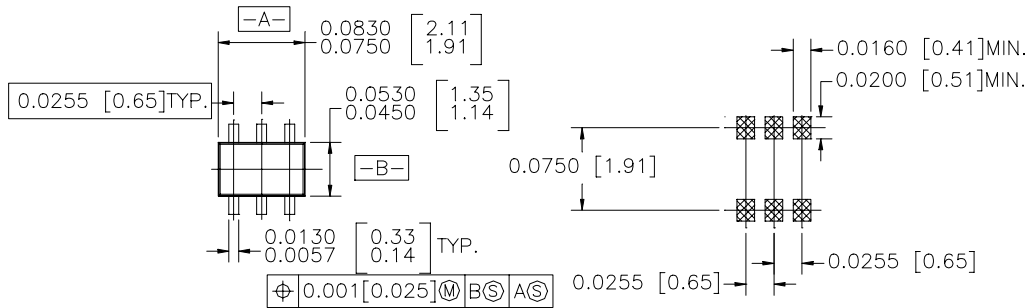

LAND PATTERN RECOMMENDATION

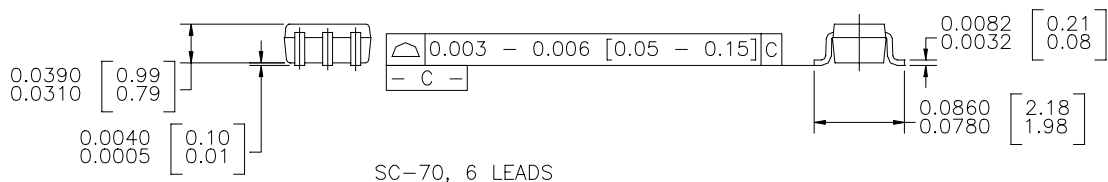

## TRADEMARKS

The following are registered and unregistered trademarks Fairchild Semiconductor owns or is authorized to use and is not intended to be an exhaustive list of all such trademarks.

ACEx™	ISOPLANAR™	TinyLogic™
CoolFET™	MICROWIRE™	UHC™
CROSSVOLT™	POP™	VCX™
E <sup>2</sup> CMOS™	PowerTrench™	
FACT™	QFET™	
FACT Quiet Series™	QS™	
FAST®	Quiet Series™	
FASTr™	SuperSOT™-3	
GTO™	SuperSOT™-6	
HiSeC™	SuperSOT™-8	

## DISCLAIMER

FAIRCHILD SEMICONDUCTOR RESERVES THE RIGHT TO MAKE CHANGES WITHOUT FURTHER NOTICE TO ANY PRODUCTS HEREIN TO IMPROVE RELIABILITY, FUNCTION OR DESIGN. FAIRCHILD DOES NOT ASSUME ANY LIABILITY ARISING OUT OF THE APPLICATION OR USE OF ANY PRODUCT OR CIRCUIT DESCRIBED HEREIN; NEITHER DOES IT CONVEY ANY LICENSE UNDER ITS PATENT RIGHTS, NOR THE RIGHTS OF OTHERS.

## LIFE SUPPORT POLICY

FAIRCHILD'S PRODUCTS ARE NOT AUTHORIZED FOR USE AS CRITICAL COMPONENTS IN LIFE SUPPORT DEVICES OR SYSTEMS WITHOUT THE EXPRESS WRITTEN APPROVAL OF FAIRCHILD SEMICONDUCTOR CORPORATION. As used herein:

1. Life support devices or systems are devices or systems which, (a) are intended for surgical implant into the body, or (b) support or sustain life, or (c) whose failure to perform when properly used in accordance with instructions for use provided in the labeling, can be reasonably expected to result in significant injury to the user.
2. A critical component is any component of a life support device or system whose failure to perform can be reasonably expected to cause the failure of the life support device or system, or to affect its safety or effectiveness.

## PRODUCT STATUS DEFINITIONS

### Definition of Terms

Datasheet Identification	Product Status	Definition
Advance Information	Formative or In Design	This datasheet contains the design specifications for product development. Specifications may change in any manner without notice.
Preliminary	First Production	This datasheet contains preliminary data, and supplementary data will be published at a later date. Fairchild Semiconductor reserves the right to make changes at any time without notice in order to improve design.
No Identification Needed	Full Production	This datasheet contains final specifications. Fairchild Semiconductor reserves the right to make changes at any time without notice in order to improve design.
Obsolete	Not In Production	This datasheet contains specifications on a product that has been discontinued by Fairchild semiconductor. The datasheet is printed for reference information only.