

## DC/DC Power Modules 1.65 – 3 W PKV 3000 I – PKV 5000 I

- *Wide input voltage range, 9–36 V, 18–72 V*
- *High efficiency 74–83% typical*
- *Low idling power*
- *Full output power up to +75 °C ambient temperature*
- *Input/Output isolation 1,500 Vdc*
- *MTBF > 650,000 hours at +25 °C ambient*



The PKV series of DC/DC power modules is intended for general use in 12/24 V and 48/60 V DC systems. Designed with MOSFET transistors and 200 kHz switching frequency, they are characterized by high efficiency over a wide load range, very low quiescent power and an excellent line and load regulation. The DC/DC power modules are encapsulated in an epoxy filled plastic box. The flammability ratings of

the encapsulating materials are in conformance with UL 94V-0 and have an adequate thermal conductivity. The materials withstand all normal PBA cleaning methods.

Ericsson Microelectronics AB has been an ISO 9001 certified supplier since 1991.

*For a complete product program please reference the back cover.*

# General

## Absolute Maximum Ratings

Characteristics		min	max	Units
T <sub>C</sub>	Case temperature <sup>1)</sup>	-40	+95	°C
T <sub>S</sub>	Storage temperature	-40	+125	°C
V <sub>I</sub>	Input voltage, 0.1 s max PKV 3000 PKV 5000		40 80	Vdc
V <sub>ISO</sub>	Isolation voltage (input to output test voltage)	1,500		Vdc

Stress in excess of Absolute Maximum Ratings may cause permanent damage. Absolute Maximum Ratings, sometimes referred to as no destruction limits, are normally tested with one parameter at a time exceeding the limits of Output data or Electrical Characteristics. If exposed to stress above these limits, function and performance may degrade in an unspecified manner.

## Power Derating

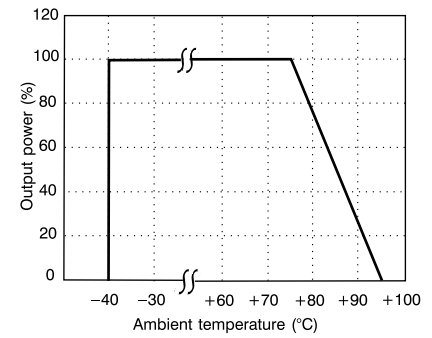

## Input T<sub>A</sub> = +25°C, unless otherwise specified

Characteristics		Conditions	min	typ	max	Units
V <sub>I</sub>	Input voltage range	T <sub>A</sub> = -40 to +75°C PKV 3000 PKV 5000	9 18		36 72	V
V <sub>off</sub>	Turn-off input voltage	PKV 3000 PKV 5000			8 16	V
	Inrush current Peak I <sup>2</sup> t	Low loss, low inductive capacitive source PKV 3000 PKV 5000		35 0.005 0.005		A A <sup>2</sup> s A <sup>2</sup> s
	Idling power	I <sub>O</sub> = 0		0.3		W
V <sub>fac</sub>	Ripple voltage	I <sub>O</sub> = I <sub>Omax</sub> , BW = 20 MHz		100		mV <sub>p-p</sub>

These DC/DC power modules operate without any external components. However, in low noise applications it is recommended to use a filter. Please see EMC information included in this data sheet.

It is recommended to protect the input source by fuses or other protection devices. Fuses are not supplied internally. A slow fuse with rating of 2× the I<sub>Imax</sub> is recommended.

## Miscellaneous

Characteristics		Conditions	min	typ	max	Unit
	Input/Output coupling capacitor	RH = 48%, T <sub>C</sub> = +25°C f = 100 Hz		1000		pF
	Switching frequency	V <sub>I</sub> = V <sub>I nom</sub> , I <sub>O</sub> = I <sub>O max</sub>		200		kHz

## Environmental Characteristics

Test method	Reference	Test procedure & conditons	
Vibration (Sinusoidal)	IEC 68-2-6 F <sub>C</sub>	Frequency Amplitude Acceleration Number of cycles Test duration	10...500Hz 0.75 mm 10 g 10 in each axis 1 h per axis
Shock (Half-sinus)	IEC 68-2-27 E <sub>a</sub>	Peak acceleration Shock duration	2000 m/s <sup>2</sup> 3 ms
Temperature change	IEC 68-2-14 N <sub>a</sub>	Temperature Number of cycles	-40°C to +125°C 100

Note:

<sup>1)</sup> Corresponding typical ambient temperature range (T<sub>A</sub>) at full output power is -40 to +75°C.

## Mechanical Data

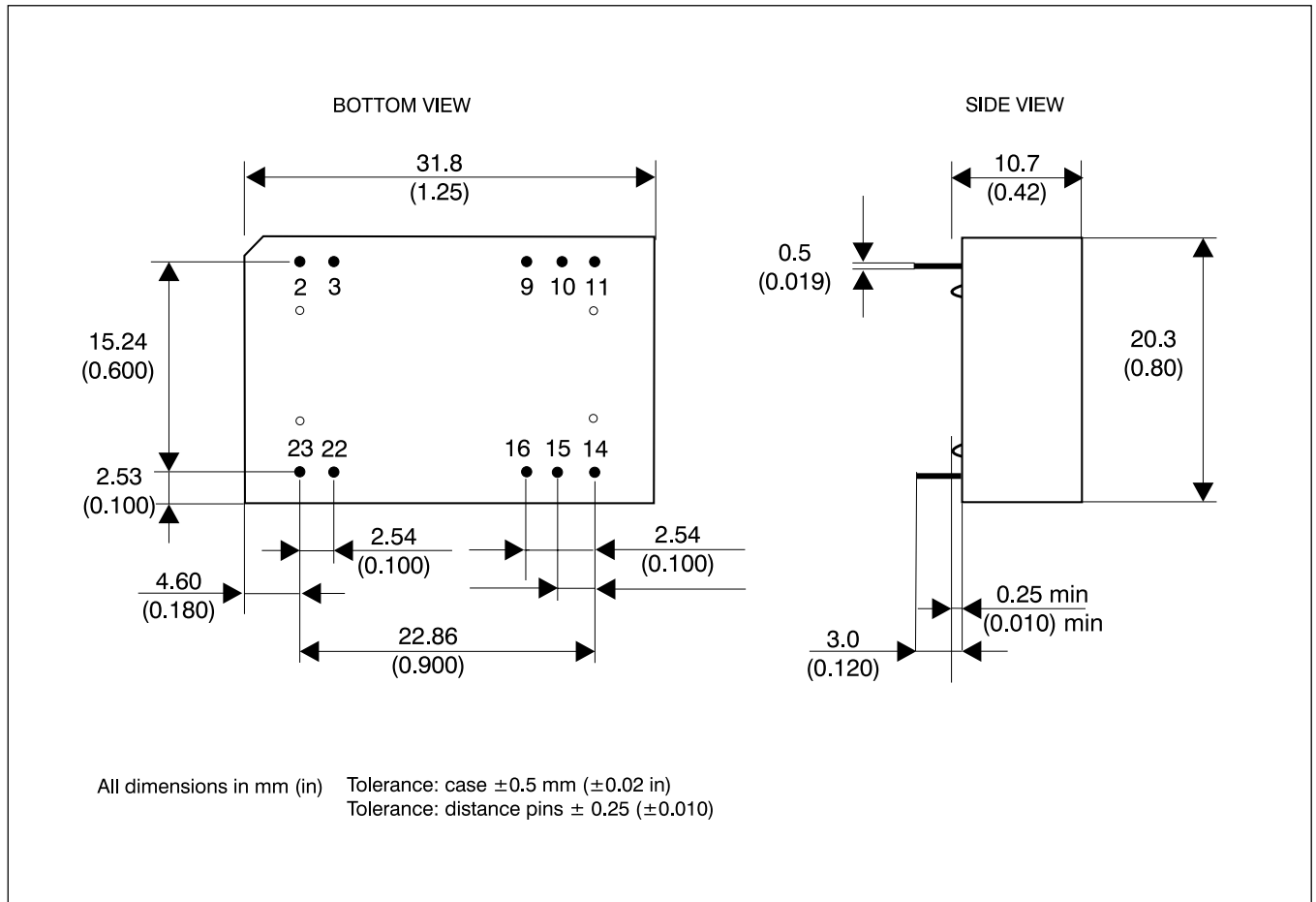

## Connections

Pin	Designation	Function	
		Single output	Dual output
2	-In	Negative input	Negative input
3	-In	Negative input	Negative input
9	NC/Rtn	Not connected	Output return
10	NC	Not connected	Not connected
11	NC/-Out	Not connected	Negative output
14	+Out	Positive output	Positive output
15	NC	Not connected	Not connected
16	Rtn	Output return	Output return
22	+In	Positive input	Positive input
23	+In	Positive input	Positive input

## Weight

Maximum 15 g  
(0.53 oz).

## Case

Non conductive plastic, UL 94V-0.

# PKV 3110 PI

## Output

$T_A = +25^\circ\text{C}$ ,  $V_I = 9\text{...}36\text{ V}$  unless otherwise specified.

Characteristics		Conditions		Output 1			Unit
				min	typ	max	
$V_O$	Output voltage tolerance band	$I_O = 0.1 \dots 1.0 \times I_{O\text{max}}$ and long term drift		3.20		3.40	V
	Line regulation	$I_O = I_{O\text{max}}$			6.6	16.5	mV
	Load regulation	$I_O = 0.1 \dots 1.0 \times I_{O\text{max}}$ , $V_I = 26\text{ V}$			6.6	33	mV
$t_{\text{tr}}$	Load transient recovery time	$I_O = 0.1 \dots 1.0 \times I_{O\text{max}}$ , $V_I = 26\text{ V}$ load step = $0.5 \times I_{O\text{max}}$			300		$\mu\text{s}$
$V_{\text{tr}}$	Load transient voltage				+100		mV
					-100		mV
$T_{\text{coeff}}$	Temperature coefficient	Measured after stabilization				$\pm 0.02$	$\%/^\circ\text{C}$
$t_r$	Ramp-up time	$I_O = 0.1 \dots 1.0 \times I_{O\text{max}}$ , $V_I = 26\text{ V}$	$0.1 \dots 0.9 \times V_O$		0.5		ms
$t_s$	Start-up time		From $V_I$ connection to $V_O = 0.9 \times V_{O1}$		800	1300	ms
$I_O$	Output current					0.5	A
$P_{O\text{max}}$	Max output power			1.65			W
$I_{\text{lim}}$	Current limiting threshold <sup>1)</sup>	$T_C < T_{C\text{max}}$		0.50		1.62	A
$I_{\text{sc}}$	Short circuit current	$V_I = 26\text{ V}$			0.20		A
$V_{O\text{ac}}$	Output ripple & noise	$I_O = I_{O\text{max}}$ , $T_A = 25^\circ\text{C}$	DC ... 20 MHz		60		mV <sub>p-p</sub>
SVR	Supply voltage rejection (ac)	$f = 100/120\text{ Hz sine wave}$ , $1\text{ V}_{p-p}$ , ( $\text{SVR} = 20 \log(1\text{ V}_{p-p}/V_{O\text{p-p}})$ )			60		dB

<sup>1)</sup> At  $V_{\text{out}} \leq 80\%$  of nominal the power module goes into hick up mode.

## Miscellaneous

Efficiency (typ)

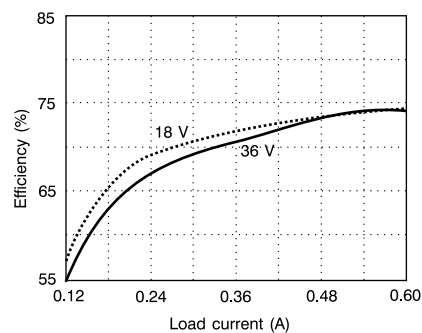

Characteristics		Conditions		min	typ	max	Unit
$\eta$	Efficiency	$I_O = I_{O\text{max}}$ , $V_I = 26\text{ V}$		66	73		%
$P_d$	Power dissipation	$I_O = I_{O\text{max}}$ , $V_I = 26\text{ V}$			0.61	0.85	W

# PKV 3211 PI

## Output

$T_A = +25^\circ\text{C}$ ,  $V_I = 9\text{...}36\text{ V}$  unless otherwise specified.

Characteristics		Conditions		Output 1			Unit
				min	typ	max	
$V_O$	Output voltage tolerance band	$I_O = 0.1 \dots 1.0 \times I_{O\text{max}}$ and long term drift		4.90		5.10	V
	Line regulation	$I_O = I_{O\text{max}}$			10	25	mV
	Load regulation	$I_O = 0.1 \dots 1.0 \times I_{O\text{max}}$ , $V_I = 26\text{ V}$			10	50	mV
$t_{\text{tr}}$	Load transient recovery time	$I_O = 0.1 \dots 1.0 \times I_{O\text{max}}$ , $V_I = 26\text{ V}$ load step = $0.5 \times I_{O\text{max}}$			300		$\mu\text{s}$
$V_{\text{tr}}$	Load transient voltage				+100		mV
					-100		mV
$T_{\text{coeff}}$	Temperature coefficient	Measured after stabilization				$\pm 0.02$	%/ $^\circ\text{C}$
$t_r$	Ramp-up time	$I_O = 0.1 \dots 1.0 \times I_{O\text{max}}$ , $V_I = 26\text{ V}$	$0.1 \dots 0.9 \times V_O$		0.5		ms
$t_s$	Start-up time		From $V_I$ connection to $V_O = 0.9 \times V_{O\text{i}}$		800	1300	ms
$I_O$	Output current					0.5	A
$P_{O\text{max}}$	Max output power			2.5			W
$I_{\text{lim}}$	Current limiting threshold <sup>1)</sup>	$T_C < T_{C\text{max}}$		0.5		1.62	A
$I_{\text{sc}}$	Short circuit current	$V_I = 26\text{ V}$			0.25		A
$V_{O\text{ac}}$	Output ripple & noise	$I_O = I_{O\text{max}}$ , $T_A = 25^\circ\text{C}$	DC/20 MHz		60		mV <sub>p-p</sub>
SVR	Supply voltage rejection (ac)	$f = 100/120\text{ Hz}$ sine wave, $1\text{ V}_{p-p}$ , ( $\text{SVR} = 20 \log(1\text{ V}_{p-p}/V_{O\text{p-p}})$ )			60		dB

<sup>1)</sup> At  $V_{\text{out}} \leq 80\%$  of nominal the power module goes into hiccup mode.

## Miscellaneous

Efficiency (typ)

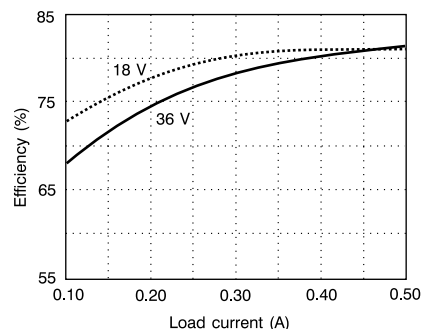

Characteristics		Conditions		min	typ	max	Unit
$\eta$	Efficiency	$I_O = I_{O\text{max}}$ , $V_I = 26\text{ V}$		76	82		%
$P_d$	Power dissipation	$I_O = I_{O\text{max}}$ , $V_I = 26\text{ V}$			0.55	0.79	W

# PKV 3313 PI

## Output

$T_A = +25^\circ\text{C}$ ,  $V_I = 9\text{...}36\text{ V}$  unless otherwise specified.

Characteristics		Conditions		Output 1			Unit	
				min	typ	max		
$V_O$	Output voltage tolerance band	$I_O = 0.1 \dots 1.0 \times I_{O\text{max}}$ and long term drift		11.76		12.24	V	
	Line regulation	$I_O = I_{O\text{max}}$			24	60	mV	
	Load regulation	$I_O = 0.1 \dots 1.0 \times I_{O\text{max}}$ , $V_I = 26\text{ V}$			24	120	mV	
$t_{tr}$	Load transient recovery time	$I_O = 0.1 \dots 1.0 \times I_{O\text{max}}$ , $V_I = 26\text{ V}$ load step = $0.5 \times I_{O\text{max}}$			300		$\mu\text{s}$	
$V_{tr}$	Load transient voltage				+150			mV
						-150		
$T_{\text{coeff}}$	Temperature coefficient	Measured after stabilization				$\pm 0.02$	$\%/^\circ\text{C}$	
$t_r$	Ramp-up time	$I_O = 0.1 \dots 1.0 \times I_{O\text{max}}$ , $V_I = 26\text{ V}$	$0.1 \dots 0.9 \times V_O$		1.2		ms	
$t_s$	Start-up time		From $V_I$ connection to $V_O = 0.9 \times V_{O1}$		800	1300		ms
$I_O$	Output current					0.25	A	
$P_{O\text{max}}$	Max output power			3			W	
$I_{\text{lim}}$	Current limiting threshold <sup>1)</sup>	$T_C < T_{C\text{max}}$		0.25		0.81	A	
$I_{\text{sc}}$	Short circuit current	$V_I = 26\text{ V}$			0.35		A	
$V_{O\text{ac}}$	Output ripple & noise	$I_O = I_{O\text{max}}$ , $T_A = 25^\circ\text{C}$	DC ... 20 MHz		60		mV <sub>p-p</sub>	
SVR	Supply voltage rejection (ac)	$f = 100/120\text{ Hz}$ sine wave, $1 V_{p-p}$ , ( $\text{SVR} = 20 \log(1 V_{p-p}/V_{O\text{p-p}})$ )			60		dB	

<sup>1)</sup> At  $V_{\text{out}} \leq 80\%$  of nominal the power module goes into hick up mode.

## Miscellaneous

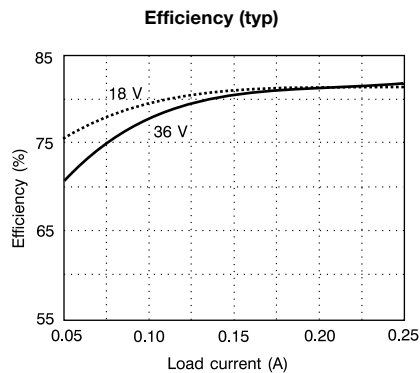

Characteristics		Conditions	min	typ	max	Unit
$\eta$	Efficiency	$I_O = I_{O\text{max}}$ , $V_I = 26\text{ V}$	76	82		%
$P_d$	Power dissipation	$I_O = I_{O\text{max}}$ , $V_I = 26\text{ V}$		0.66	0.95	W

# PKV 3315 PI

## Output

$T_A = +25^\circ\text{C}$ ,  $V_I = 9...36\text{ V}$  unless otherwise specified.

Characteristics		Conditions		Output 1			Unit	
				min	typ	max		
$V_O$	Output voltage tolerance band	$I_O = 0.1 \dots 1.0 \times I_{Omax}$ and long term drift		14.7		15.3	V	
	Line regulation	$I_O = I_{Omax}$			30	75	mV	
	Load regulation	$I_O = 0.1 \dots 1.0 \times I_{Omax}$ , $V_I = 26\text{ V}$			30	150	mV	
$t_{tr}$	Load transient recovery time	$I_O = 0.1 \dots 1.0 \times I_{Omax}$ , $V_I = 26\text{ V}$ load step = $0.5 \times I_{Omax}$			300		$\mu\text{s}$	
$V_{tr}$	Load transient voltage				+200			mV
					-200			mV
$T_{coeff}$	Temperature coefficient	Measured after stabilization				$\pm 0.02$	%/ $^\circ\text{C}$	
$t_r$	Ramp-up time	$I_O = 0.1 \dots 1.0 \times I_{Omax}$ , $V_I = 26\text{ V}$	$0.1 \dots 0.9 \times V_O$		1.2		ms	
$t_s$	Start-up time		From $V_I$ connection to $V_O = 0.9 \times V_{O1}$		800	1300	ms	
$I_O$	Output current					0.2	A	
$P_{Omax}$	Max output power				3		W	
$I_{lim}$	Current limiting threshold <sup>1)</sup>	$T_C < T_{Cmax}$			0.2	0.65	A	
$I_{sc}$	Short circuit current	$V_I = 26\text{ V}$			0.35		A	
$V_{Oac}$	Output ripple & noise	$I_O = I_{Omax}$ , $T_A = 25^\circ\text{C}$	DC ... 20 MHz		60		mV <sub>p-p</sub>	
SVR	Supply voltage rejection (ac)	$f = 100/120\text{ Hz sine wave}$ , $1 V_{p-p}$ , ( $SVR = 20 \log(1 V_{p-p}/V_{O p-p})$ )			60		dB	

<sup>1)</sup> At  $V_{out} \leq 80\%$  of nominal the power module goes into hick up mode.

## Miscellaneous

Efficiency (typ)

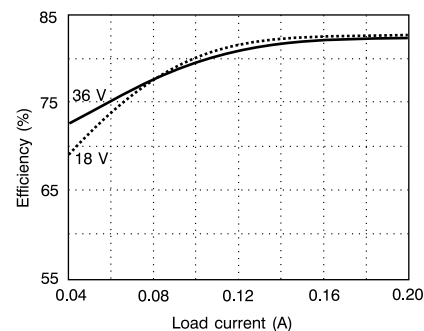

Characteristics		Conditions		min	typ	max	Unit
$\eta$	Efficiency	$I_O = I_{Omax}$ , $V_I = 26\text{ V}$		76	82		%
$P_d$	Power dissipation	$I_O = I_{Omax}$ , $V_I = 26\text{ V}$			0.66	0.95	W

# PKV 3222 PI

## Output

$T_A = +25^\circ\text{C}$ ,  $V_I = 9\text{...}36\text{V}$  unless otherwise specified.

Characteristics		Conditions		Output 1			Output 2			Unit
				min	typ	max	min	typ	max	
$V_O$	Output voltage tolerance band	$I_O = 0.1 \dots 1.0 \times I_{O\text{max}}$ and long term drift		+4.9		+5.1	-4.9		-5.1	V
	Line regulation	$I_O = I_{O\text{max}}$		10		25	10		25	mV
	Load regulation	$I_O = 0.1 \dots 1.0 \times I_{O\text{max}}$ , $V_I = 26\text{ V}$		10		50	10		50	mV
$t_{tr}$	Load transient recovery time	$I_O = 0.1 \dots 1.0 \times I_{O\text{max}}$ , $V_I = 26\text{ V}$ load step = $0.5 \times I_{O\text{max}}$		300			300			$\mu\text{s}$
$V_{tr}$	Load transient voltage			+100			+100			mV
				-100			-100			mV
$T_{\text{coeff}}$	Temperature coefficient	Measured after stabilization		$\pm 0.02$			$\pm 0.02$			%/ $^\circ\text{C}$
$t_r$	Ramp-up time	$I_O = 0.1 \dots 1.0 \times I_{O\text{max}}$ , $V_I = 26\text{ V}$	$0.1 \dots 0.9 \times V_O$	1.2			1.2			ms
$t_s$	Start-up time		From $V_I$ connection to $V_O = 0.9 \times V_{O_i}$	800	1300	800	1300	ms		
$I_O$	Output current			0.25			0.25			A
$P_{O\text{max}}$	Max output power			1.25			1.25			W
$I_{\text{lim}}$	Current limiting threshold <sup>1)</sup>	$T_C < T_{C\text{max}}$		0.25		0.81	0.25		0.81	A
$I_{\text{sc}}$	Short circuit current	$V_I = 26\text{ V}$		0.25			0.25			A
$V_{O\text{ac}}$	Output ripple & noise	$I_O = I_{O\text{max}}$ , $T_A = 25^\circ\text{C}$	DC...20 MHz	60			60			mV <sub>p-p</sub>
SVR	Supply voltage rejection (ac)	$f = 100/120\text{ Hz sine wave}$ , $1V_{p-p}$ , (SVR = $20 \log(1 V_{p-p}/V_{O\text{p-p}})$ )		45			45			dB

<sup>1)</sup> At  $V_{\text{out}} \leq 80\%$  of nominal the power module goes into hick up mode.

## Miscellaneous

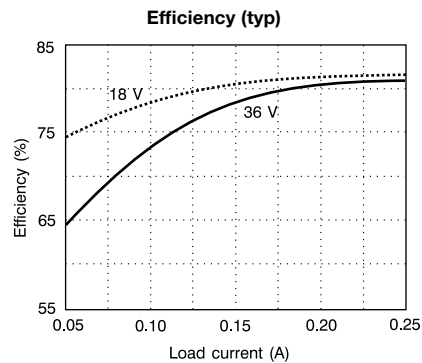

Characteristics		Conditions		min	typ	max	Unit
$\eta$	Efficiency	$I_O = I_{O\text{max}}$ , $V_I = 26\text{ V}$		75	82		%
$P_d$	Power dissipation	$I_O = I_{O\text{max}}$ , $V_I = 26\text{ V}$			0.55	0.83	W



# PKV 3321 PI

## Output

$T_A = +25^\circ\text{C}$ ,  $V_I = 9\text{...}36\text{V}$  unless otherwise specified.

Characteristics		Conditions	Output 1			Output 2			Unit
			min	typ	max	min	typ	max	
$V_O$	Output voltage tolerance band	$I_O = 0.1 \dots 1.0 \times I_{O\text{max}}$ and long term drift	+11.76		+12.24	-11.76		-12.24	V
	Line regulation	$I_O = I_{O\text{max}}$	24		60	24		60	mV
	Load regulation	$I_O = 0.1 \dots 1.0 \times I_{O\text{max}}$ , $V_I = 26\text{ V}$	24		120	24		120	mV
$t_{\text{tr}}$	Load transient recovery time	$I_O = 0.1 \dots 1.0 \times I_{O\text{max}}$ , $V_I = 26\text{ V}$ load step = $0.5 \times I_{O\text{max}}$	300			300			$\mu\text{s}$
$V_{\text{tr}}$	Load transient voltage		+150			+150			mV
			-150			-150			mV
$T_{\text{coeff}}$	Temperature coefficient	Measured after stabilization			$\pm 0.02$			$\% / ^\circ\text{C}$	
$t_r$	Ramp-up time	$I_O = 0.1 \dots 1.0 \times I_{O\text{max}}$ , $V_I = 26\text{ V}$	$0.1 \dots 0.9 \times V_O$		1.2		1.2		ms
$t_s$	Start-up time		From $V_I$ connection to $V_O = 0.9 \times V_{O_i}$		800	1300	800	1300	ms
$I_O$	Output current				0.125		0.125		A
$P_{O\text{max}}$	Max output power				1.5		1.5		W
$I_{\text{lim}}$	Current limiting threshold <sup>1)</sup>	$T_C < T_{C\text{max}}$			0.125	0.400	0.125	0.400	A
$I_{\text{sc}}$	Short circuit current	$V_I = 26\text{ V}$			0.35		0.35		A
$V_{O\text{ac}}$	Output ripple & noise	$I_O = I_{O\text{max}}$ , $T_A = 25^\circ\text{C}$	DC...20 MHz		60		60		mV <sub>p-p</sub>
SVR	Supply voltage rejection (ac)	$f = 100/120\text{ Hz sine wave}$ , $1\text{ V}_{p-p}$ , ( $\text{SVR} = 20 \log(1 \text{ V}_{p-p}/V_{O\text{p-p}})$ )			45		45		dB

<sup>1)</sup> At  $V_{\text{out}} \leq 80\%$  of nominal the power module goes into hick up mode.

## Miscellaneous

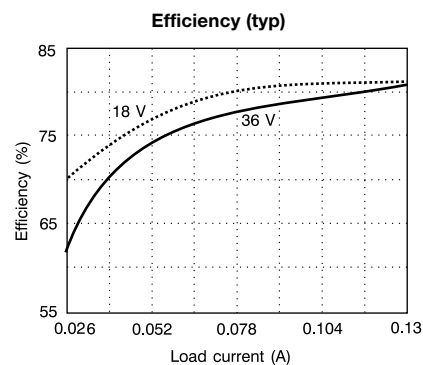

Characteristics		Conditions	min	typ	max	Unit
$\eta$	Efficiency	$I_O = I_{O\text{max}}$ , $V_I = 26\text{ V}$	73	82		%
$P_d$	Power dissipation	$I_O = I_{O\text{max}}$ , $V_I = 26\text{ V}$		0.66	1.11	W

# PKV 3325 PI

## Output

$T_A = +25^\circ\text{C}$ ,  $V_I = 9\text{...}36\text{V}$  unless otherwise specified.

Characteristics		Conditions	Output 1			Output 2			Unit
			min	typ	max	min	typ	max	
$V_O$	Output voltage tolerance band	$I_O = 0.1 \dots 1.0 \times I_{O\text{max}}$ and long term drift	+14.7		+15.3	-14.7		-15.3	V
	Line regulation	$I_O = I_{O\text{max}}$		30	75		30	75	mV
	Load regulation	$I_O = 0.1 \dots 1.0 \times I_{O\text{max}}$ , $V_I = 26\text{ V}$		30	150		30	150	mV
$t_{\text{tr}}$	Load transient recovery time	$I_O = 0.1 \dots 1.0 \times I_{O\text{max}}$ , $V_I = 26\text{ V}$ load step = $0.5 \times I_{O\text{max}}$		300			300		$\mu\text{s}$
$V_{\text{tr}}$	Load transient voltage		+200		+200				mV
			-200		-200				mV
$T_{\text{coeff}}$	Temperature coefficient	Measured after stabilization			$\pm 0.02$		$\pm 0.02$		%/ $^\circ\text{C}$
$t_r$	Ramp-up time	$I_O = 0.1 \dots 1.0 \times I_{O\text{max}}$ , $V_I = 26\text{ V}$	$0.1 \dots 0.9 \times V_O$			1.2		1.2	ms
$t_s$	Start-up time		From $V_I$ connection to $V_O = 0.9 \times V_{O_i}$		800	1300	800	1300	ms
$I_O$	Output current			0.1		0.1		A	
$P_{O\text{max}}$	Max output power		1.5		1.5			W	
$I_{\text{lim}}$	Current limiting threshold <sup>1)</sup>	$T_C < T_{C\text{max}}$	0.10		0.32	0.10		0.32	A
$I_{\text{sc}}$	Short circuit current	$V_I = 26\text{ V}$		0.35		0.35			A
$V_{O\text{ac}}$	Output ripple & noise	$I_O = I_{O\text{max}}$ , $T_A = 25^\circ\text{C}$	DC...20 MHz			50		50	mV <sub>p-p</sub>
SVR	Supply voltage rejection (ac)	$f = 100/120\text{ Hz sine wave}$ , $1 V_{p-p}$ , (SVR = $20 \log(1 V_{p-p}/V_{O\text{p-p}})$ )			45		45		dB

<sup>1)</sup> At  $V_{\text{out}} \leq 80\%$  of nominal the power module goes into hick up mode.

## Miscellaneous

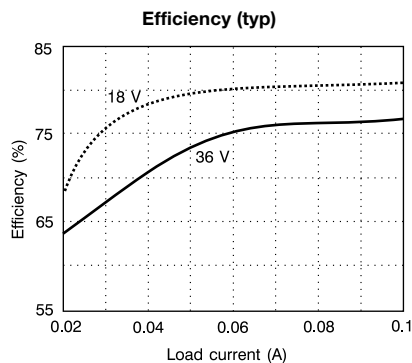

Characteristics		Conditions	min	typ	max	Unit
$\eta$	Efficiency	$I_O = I_{O\text{max}}$ , $V_I = 26\text{ V}$	76	80		%
$P_d$	Power dissipation	$I_O = I_{O\text{max}}$ , $V_I = 26\text{ V}$		0.75	0.95	W

# PKV 5110 PI

## Output

$T_A = +25^\circ\text{C}$ ,  $V_I = 18\text{...}72\text{V}$  unless otherwise specified.

Characteristics		Conditions		Output 1			Unit	
				min	typ	max		
$V_O$	Output voltage tolerance band	$I_O = 0.1 \dots 1.0 \times I_{O\text{max}}$ and long term drift		3.20		3.40	V	
	Line regulation	$I_O = I_{O\text{max}}$			6.6	16.5	mV	
	Load regulation	$I_O = 0.1 \dots 1.0 \times I_{O\text{max}}$ , $V_I = 53\text{V}$			6.6	33.0	mV	
$t_{\text{tr}}$	Load transient recovery time	$I_O = 0.1 \dots 1.0 \times I_{O\text{max}}$ , $V_I = 53\text{V}$ load step = $0.5 \times I_{O\text{max}}$			300		$\mu\text{s}$	
$V_{\text{tr}}$	Load transient voltage				+100			mV
						-100		
$T_{\text{coeff}}$	Temperature coefficient	Measured after stabilization				$\pm 0.02$	%/ $^\circ\text{C}$	
$t_r$	Ramp-up time	$I_O = 0.1 \dots 1.0 \times I_{O\text{max}}$ , $V_I = 53\text{V}$	$0.1 \dots 0.9 \times V_O$		0.5		ms	
$t_s$	Start-up time		From $V_I$ connection to $V_O = 0.9 \times V_{O\text{i}}$		900	1300	ms	
$I_O$	Output current					0.5	A	
$P_{O\text{max}}$	Max output power				1.65		W	
$I_{\text{lim}}$	Current limiting threshold <sup>1)</sup>	$T_C < T_{C\text{max}}$			0.50	1.62	A	
$I_{\text{sc}}$	Short circuit current	$V_I = 53\text{V}$			0.1		A	
$V_{O\text{ac}}$	Output ripple & noise	$I_O = I_{O\text{max}}$ , $T_A = 25^\circ\text{C}$	DC ... 20 MHz		60		mV <sub>p-p</sub>	
SVR	Supply voltage rejection (ac)	$f = 100/120\text{ Hz sine wave}$ , $1 V_{p-p}$ , ( $\text{SVR} = 20 \log(1 V_{p-p}/V_{O\text{p-p}})$ )			60		dB	

<sup>1)</sup> At  $V_{\text{out}} \leq 80\%$  of nominal the power module goes into hiccup mode.

## Miscellaneous

Efficiency (typ)

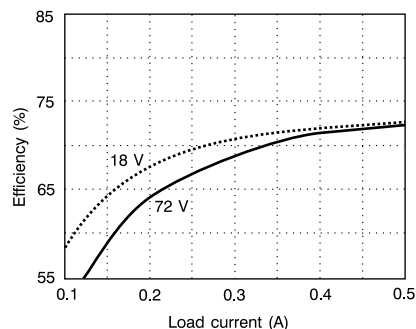

Characteristics		Conditions		min	typ	max	Unit
$\eta$	Efficiency	$I_O = I_{O\text{max}}$ , $V_I = 53\text{V}$		66	73		%
$P_d$	Power dissipation	$I_O = I_{O\text{max}}$ , $V_I = 53\text{V}$			0.61	0.85	W

# PKV 5211 PI

## Output

$T_A = +25^\circ\text{C}$ ,  $V_I = 18...72\text{V}$  unless otherwise specified.

Characteristics		Conditions		Output 1			Unit
				min	typ	max	
$V_O$	Output voltage tolerance band	$I_O = 0.1 \dots 1.0 \times I_{O\max}$ and long term drift		4.90		5.10	V
	Line regulation	$I_O = I_{O\max}$			10	25	mV
	Load regulation	$I_O = 0.1 \dots 1.0 \times I_{O\max}$ , $V_I = 53\text{V}$			10	50	mV
$t_{tr}$	Load transient recovery time	$I_O = 0.1 \dots 1.0 \times I_{O\max}$ , $V_I = 53\text{V}$ load step = $0.5 \times I_{O\max}$			300		$\mu\text{s}$
$V_{tr}$	Load transient voltage				+100		mV
					-100		mV
$T_{\text{coeff}}$	Temperature coefficient	Measured after stabilization				$\pm 0.02$	%/ $^\circ\text{C}$
$t_r$	Ramp-up time	$I_O = 0.1 \dots 1.0 \times I_{O\max}$ , $V_I = 53\text{V}$	$0.1 \dots 0.9 \times V_O$		0.5		ms
$t_s$	Start-up time		From $V_I$ connection to $V_O = 0.9 \times V_{O1}$		900	1300	ms
$I_O$	Output current					0.5	A
$P_{O\max}$	Max output power			2.5			W
$I_{\text{lim}}$	Current limiting threshold <sup>1)</sup>	$T_C < T_{C\max}$		0.5		1.62	A
$I_{\text{sc}}$	Short circuit current	$V_I = 53\text{V}$			0.12		A
$V_{Oac}$	Output ripple & noise	$I_O = I_{O\max}$ , $T_A = 25^\circ\text{C}$	DC ... 20 MHz		60		mV <sub>p-p</sub>
SVR	Supply voltage rejection (ac)	$f = 100/120\text{ Hz sine wave}$ , $1 V_{p-p}$ , ( $\text{SVR} = 20 \log(1 V_{p-p}/V_{O\text{p-p}})$ )			60		dB

<sup>1)</sup> At  $V_{\text{out}} \leq 80\%$  of nominal the power module goes into hiccup mode.

## Miscellaneous

Efficiency (typ)

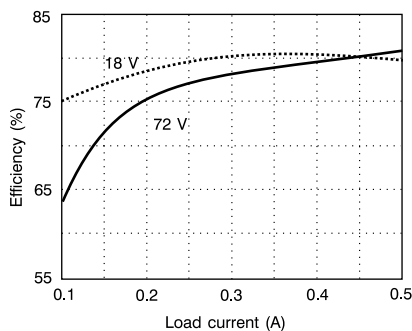

Characteristics		Conditions		min	typ	max	Unit
$\eta$	Efficiency	$I_O = I_{O\max}$ , $V_I = 53\text{V}$		75	82		%
$P_d$	Power dissipation	$I_O = I_{O\max}$ , $V_I = 53\text{V}$			0.55	0.84	W

# PKV 5313 PI

## Output

$T_A = +25^\circ\text{C}$ ,  $V_I = 18\text{...}72\text{V}$  unless otherwise specified.

Characteristics		Conditions		Output 1			Unit
				min	typ	max	
$V_O$	Output voltage tolerance band	$I_O = 0.1 \dots 1.0 \times I_{O\max}$ and long term drift		11.76		12.24	V
	Line regulation	$I_O = I_{O\max}$			24	60	mV
	Load regulation	$I_O = 0.1 \dots 1.0 \times I_{O\max}$ , $V_I = 53\text{V}$			24	120	mV
$t_{tr}$	Load transient recovery time	$I_O = 0.1 \dots 1.0 \times I_{O\max}$ , $V_I = 53\text{V}$ load step = $0.5 \times I_{O\max}$			300		$\mu\text{s}$
$V_{tr}$	Load transient voltage				+150		mV
					-150		mV
$T_{\text{coeff}}$	Temperature coefficient	Measured after stabilization				$\pm 0.02$	%/ $^\circ\text{C}$
$t_r$	Ramp-up time	$I_O = 0.1 \dots 1.0 \times I_{O\max}$ , $V_I = 53\text{V}$	$0.1 \dots 0.9 \times V_O$		1.2		ms
$t_s$	Start-up time		From $V_I$ connection to $V_O = 0.9 \times V_{OI}$		900	1300	ms
$I_O$	Output current					0.25	A
$P_{O\max}$	Max output power			3			W
$I_{\text{lim}}$	Current limiting threshold <sup>1)</sup>	$T_C < T_{C\max}$		0.25		0.81	A
$I_{\text{sc}}$	Short circuit current	$V_I = 53\text{V}$			0.17		A
$V_{Oac}$	Output ripple & noise	$I_O = I_{O\max}$ , $T_A = 25^\circ\text{C}$	DC... 20 MHz		60		mV <sub>p-p</sub>
SVR	Supply voltage rejection (ac)	$f = 100/120\text{ Hz sine wave}$ , $1\text{ V}_{p-p}$ , ( $\text{SVR} = 20 \log(1\text{ V}_{p-p}/V_{O\text{p-p}})$ )			60		dB

<sup>1)</sup> At  $V_{\text{out}} \leq 80\%$  of nominal the power module goes into hiccup mode.

## Miscellaneous

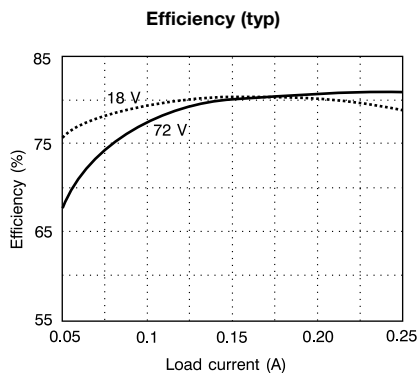

Characteristics		Conditions		min	typ	max	Unit
$\eta$	Efficiency	$I_O = I_{O\max}$ , $V_I = 53\text{V}$		76	82		%
$P_d$	Power dissipation	$I_O = I_{O\max}$ , $V_I = 53\text{V}$			0.66	0.95	W

# PKV 5315 PI

## Output

$T_A = +25^\circ\text{C}$ ,  $V_I = 18...72\text{V}$  unless otherwise specified.

Characteristics		Conditions		Output 1			Unit
				min	typ	max	
$V_O$	Output voltage tolerance band	$I_O = 0.1 \dots 1.0 \times I_{O\text{max}}$ and long term drift		14.7		15.3	V
	Line regulation	$I_O = I_{O\text{max}}$			30	75	mV
	Load regulation	$I_O = 0.1 \dots 1.0 \times I_{O\text{max}}$ , $V_I = 53\text{V}$			30	150	mV
$t_{\text{tr}}$	Load transient recovery time	$I_O = 0.1 \dots 1.0 \times I_{O\text{max}}$ , $V_I = 53\text{V}$ load step = $0.5 \times I_{O\text{max}}$			300		$\mu\text{s}$
$V_{\text{tr}}$	Load transient voltage				+200		mV
						-200	
$T_{\text{coeff}}$	Temperature coefficient	Measured after stabilization				$\pm 0.02$	%/ $^\circ\text{C}$
$t_r$	Ramp-up time	$I_O = 0.1 \dots 1.0 \times I_{O\text{max}}$ , $V_I = 53\text{V}$	$0.1 \dots 0.9 \times V_O$		1.2		ms
$t_s$	Start-up time		From $V_I$ connection to $V_O = 0.9 \times V_{O1}$		900	1300	ms
$I_O$	Output current					0.2	A
$P_{O\text{max}}$	Max output power			3			W
$I_{\text{lim}}$	Current limiting threshold <sup>1)</sup>	$T_C < T_{C\text{max}}$		0.20		0.65	A
$I_{\text{sc}}$	Short circuit current	$V_I = 53\text{V}$			0.17		A
$V_{O\text{ac}}$	Output ripple & noise	$I_O = I_{O\text{max}}$ , $T_A = 25^\circ\text{C}$	DC ... 20 MHz		60		mV <sub>p-p</sub>
SVR	Supply voltage rejection (ac)	$f = 100/120\text{ Hz sine wave}$ , $1 V_{p-p}$ , ( $\text{SVR} = 20 \log(1 V_{p-p}/V_{O\text{p-p}})$ )			60		dB

<sup>1)</sup> At  $V_{\text{out}} \leq 80\%$  of nominal the power module goes into hick up mode.

## Miscellaneous

Efficiency (typ)

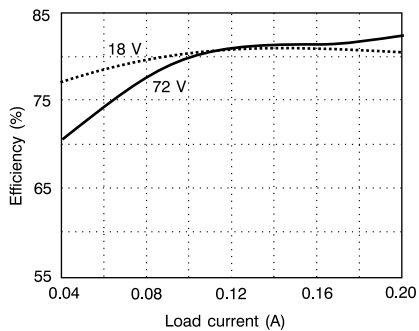

Characteristics		Conditions		min	typ	max	Unit
$\eta$	Efficiency	$I_O = I_{O\text{max}}$ , $V_I = 53\text{V}$		76	82		%
$P_d$	Power dissipation	$I_O = I_{O\text{max}}$ , $V_I = 53\text{V}$			0.66	0.95	W

# PKV 5222 PI

## Output

$T_A = +25^\circ\text{C}$ ,  $V_I = 18\text{...}72\text{V}$  unless otherwise specified.

Characteristics		Conditions	Output 1			Output 2			Unit
			min	typ	max	min	typ	max	
$V_O$	Output voltage tolerance band	$I_O = 0.1 \dots 1.0 \times I_{O\text{max}}$ and long term drift	+4.9		+5.1	-4.9		-5.1	V
	Line regulation	$I_O = I_{O\text{max}}$		10	25		10	25	mV
	Load regulation	$I_O = 0.1 \dots 1.0 \times I_{O\text{max}}$ , $V_I = 53\text{ V}$		10	50		10	50	mV
$t_{\text{tr}}$	Load transient recovery time	$I_O = 0.1 \dots 1.0 \times I_{O\text{max}}$ , $V_I = 53\text{ V}$ load step = $0.5 \times I_{O\text{max}}$		300			300		$\mu\text{s}$
$V_{\text{tr}}$	Load transient voltage		+100		+100				mV
			-100		-100				mV
$T_{\text{coeff}}$	Temperature coefficient	Measured after stabilization			$\pm 0.02$			$\% / ^\circ\text{C}$	
$t_r$	Ramp-up time	$I_O = 0.1 \dots 1.0 \times I_{O\text{max}}$ , $V_I = 53\text{ V}$	$0.1 \dots 0.9 \times V_O$		1.2		1.2		ms
$t_s$	Start-up time		From $V_I$ connection to $V_O = 0.9 \times V_{O1}$		900 1300		900 1300		ms
$I_O$	Output current		0.25		0.25		0.25		A
$P_{O\text{max}}$	Max output power		1.25		1.25		1.25		W
$I_{\text{lim}}$	Current limiting threshold <sup>1)</sup>	$T_C < T_{C\text{max}}$	0.25		0.81		0.25 0.81		A
$I_{\text{sc}}$	Short circuit current	$V_I = 53\text{ V}$	0.12		0.12		0.12		A
$V_{O\text{ac}}$	Output ripple & noise	$I_O = I_{O\text{max}}$ , $T_A = 25^\circ\text{C}$	DC ... 20 MHz		60		60		mV <sub>p-p</sub>
SVR	Supply voltage rejection (ac)	$f = 100/120\text{ Hz}$ sine wave, $1 V_{p-p}$ , ( $\text{SVR} = 20 \log(1 V_{p-p}/V_{O\text{p-p}})$ )		45		45		dB	

<sup>1)</sup> At  $V_{\text{out}} \leq 80\%$  of nominal the power module goes into hiccup mode.

## Miscellaneous

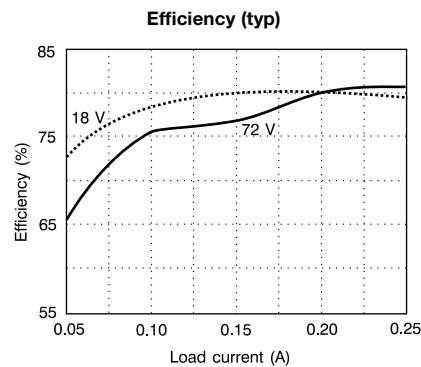

Characteristics		Conditions	min	typ	max	Unit
$\eta$	Efficiency	$I_O = I_{O\text{max}}$ , $V_I = 53\text{ V}$	75	82		%
$P_d$	Power dissipation	$I_O = I_{O\text{max}}$ , $V_I = 53\text{ V}$		0.55	0.83	W

# PKV 5321 PI

## Output

$T_A = +25^\circ\text{C}$ ,  $V_I = 9\text{...}36\text{V}$  unless otherwise specified.

Characteristics		Conditions		Output 1			Output 2			Unit
				min	typ	max	min	typ	max	
$V_O$	Output voltage tolerance band	$I_O = 0.1 \dots 1.0 \times I_{O\text{max}}$ and long term drift		+11.76		+12.24	-11.76		-12.24	V
	Line regulation	$I_O = I_{O\text{max}}$		24		60	24		60	mV
	Load regulation	$I_O = 0.1 \dots 1.0 \times I_{O\text{max}}$ , $V_I = 53\text{ V}$		24		120	24		120	mV
$t_{\text{tr}}$	Load transient recovery time	$I_O = 0.1 \dots 1.0 \times I_{O\text{max}}$ , $V_I = 53\text{ V}$ load step = $0.5 \times I_{O\text{max}}$		300			300			$\mu\text{s}$
$V_{\text{tr}}$	Load transient voltage			+150			+150			mV
				-150			-150			mV
$T_{\text{coeff}}$	Temperature coefficient	Measured after stabilization		$\pm 0.02$			$\pm 0.02$			%/ $^\circ\text{C}$
$t_r$	Ramp-up time	$I_O = 0.1 \dots 1.0 \times I_{O\text{max}}$ , $V_I = 53\text{ V}$	$0.1 \dots 0.9 \times V_O$	1.2			1.2			ms
$t_s$	Start-up time		From $V_I$ connection to $V_O = 0.9 \times V_{O1}$	900	1300	900	1300	ms		
$I_O$	Output current			0.125			0.125			A
$P_{O\text{max}}$	Max output power			1.5			1.5			W
$I_{\text{lim}}$	Current limiting threshold <sup>1)</sup>	$T_C < T_{C\text{max}}$		0.125		0.400	0.125		0.400	A
$I_{\text{sc}}$	Short circuit current	$V_I = 53\text{ V}$		0.17			0.17			A
$V_{O\text{ac}}$	Output ripple & noise	$I_O = I_{O\text{max}}$ , $T_A = 25^\circ\text{C}$	DC ... 20 MHz	60			60			mV <sub>p-p</sub>
SVR	Supply voltage rejection (ac)	$f = 100/120\text{ Hz}$ sine wave, $1 V_{p-p}$ , (SVR = $20 \log(1 V_{p-p}/V_{O\text{p-p}})$ )		45			45			dB

<sup>1)</sup> At  $V_{\text{out}} \leq 80\%$  of nominal the power module goes into hick up mode.

## Miscellaneous

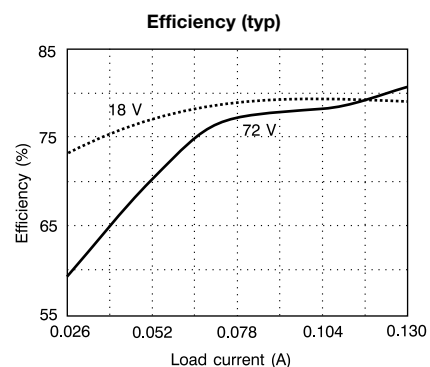

Characteristics		Conditions		min	typ	max	Unit
$\eta$	Efficiency	$I_O = I_{O\text{max}}$ , $V_I = 53\text{ V}$		73	82		%
$P_d$	Power dissipation	$I_O = I_{O\text{max}}$ , $V_I = 53\text{ V}$			0.66	1.11	W



# PKV 5325 PI

## Output

$T_A = +25^\circ\text{C}$ ,  $V_I = 9\text{...}36\text{V}$  unless otherwise specified.

Characteristics		Conditions		Output 1			Output 2			Unit
				min	typ	max	min	typ	max	
$V_O$	Output voltage tolerance band	$I_O = 0.1 \dots 1.0 \times I_{O\text{max}}$ and long term drift		+14.7		+15.3	-14.7		-15.3	V
	Line regulation	$I_O = I_{O\text{max}}$			30	75		30	75	mV
	Load regulation	$I_O = 0.1 \dots 1.0 \times I_{O\text{max}}$ , $V_I = 53\text{ V}$			30	150		30	150	mV
$t_{\text{tr}}$	Load transient recovery time	$I_O = 0.1 \dots 1.0 \times I_{O\text{max}}$ , $V_I = 53\text{ V}$ load step = $0.5 \times I_{O\text{max}}$		300			300			$\mu\text{s}$
$V_{\text{tr}}$	Load transient voltage			+200			+200			mV
				-200			-200			mV
$T_{\text{coeff}}$	Temperature coefficient	Measured after stabilization		$\pm 0.02$			$\pm 0.02$			%/ $^\circ\text{C}$
$t_r$	Ramp-up time	$I_O = 0.1 \dots 1.0 \times I_{O\text{max}}$ , $V_I = 53\text{ V}$	$0.1 \dots 0.9 \times V_O$	1.2			1.2			ms
$t_s$	Start-up time		From $V_I$ connection to $V_O = 0.9 \times V_{O1}$	900 1300			900 1300			ms
$I_O$	Output current			0.1			0.1			A
$P_{O\text{max}}$	Max output power			1.5			1.5			W
$I_{\text{lim}}$	Current limiting threshold <sup>1)</sup>	$T_C < T_{C\text{max}}$		0.10 0.32			0.10 0.32			A
$I_{\text{sc}}$	Short circuit current	$V_I = 53\text{ V}$		0.17			0.17			A
$V_{O\text{ac}}$	Output ripple & noise	$I_O = I_{O\text{max}}$ , $T_A = 25^\circ\text{C}$	DC ... 20 MHz	60			60			mV <sub>p-p</sub>
SVR	Supply voltage rejection (ac)	$f = 100/120\text{ Hz sine wave}$ , $1 V_{p-p}$ , ( $\text{SVR} = 20 \log(1 V_{p-p}/V_{O\text{p-p}})$ )		45			45			dB

<sup>1)</sup> At  $V_{\text{out}} \leq 80\%$  of nominal the power module goes into hiccup mode.

## Miscellaneous

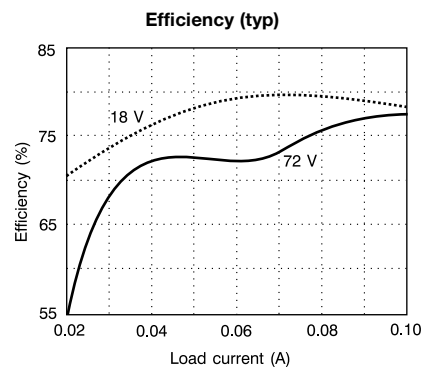

Characteristics		Conditions		min	typ	max	Unit
$\eta$	Efficiency	$I_O = I_{O\text{max}}$ , $V_I = 53\text{ V}$		76	82		%
$P_d$	Power dissipation	$I_O = I_{O\text{max}}$ , $V_I = 53\text{ V}$			0.66	0.95	W

# EMC Specifications

The PKV DC/DC power module is mounted on a double sided printed circuit board (PB) with groundplane during EMC measurements. The fundamental switching frequency is approx. 200 kHz.

The PKV series has a good input filter and will only need a simple filter to meet conducted noise according to EN 55022 level B. Fig. 1 shows an example of filter and the results for this filter is shown below.

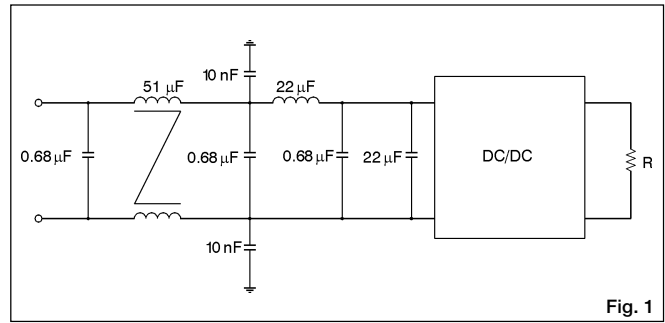
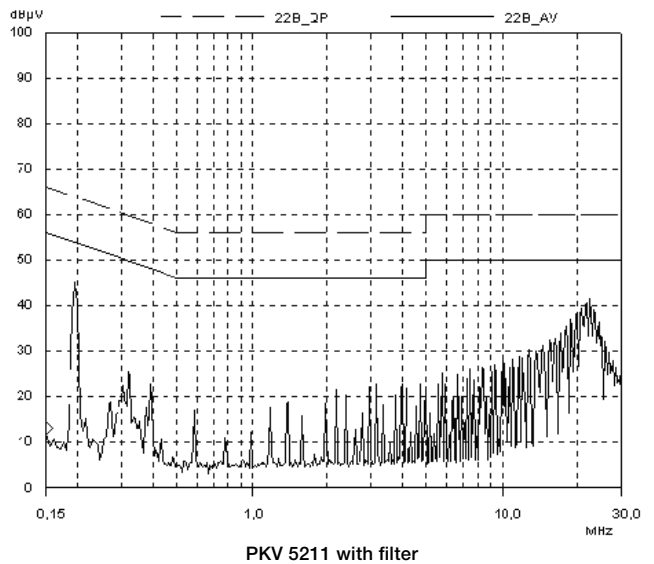
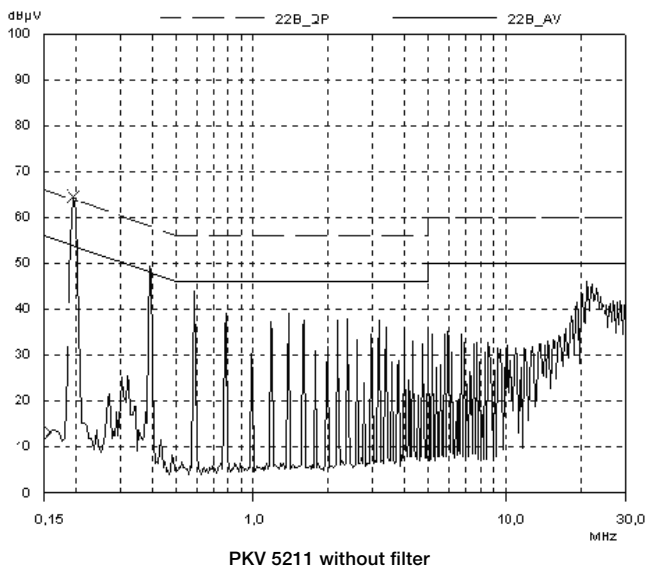
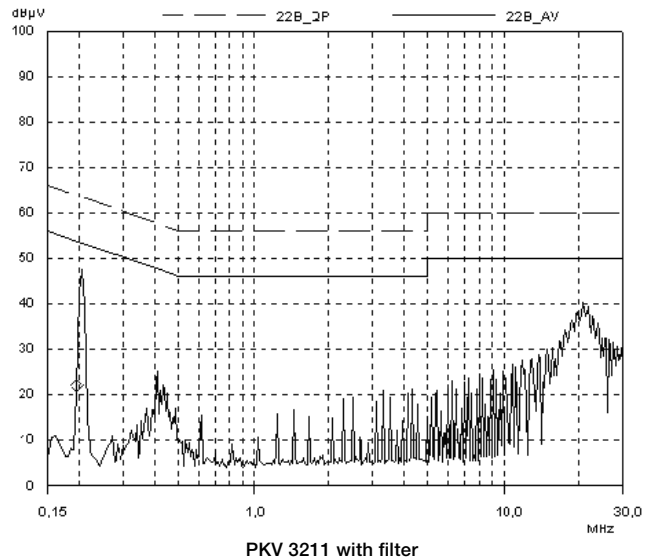
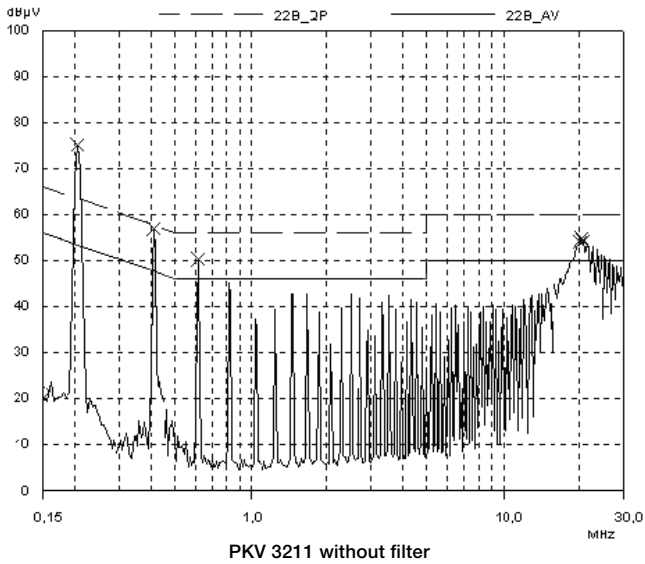
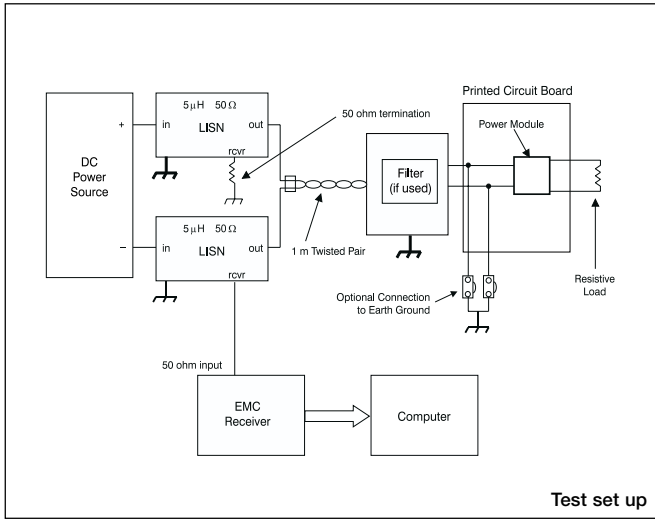

Fig. 1

## Conducted noise





## Limitation of liability

Ericsson Microelectronics does not make any other warranties, expressed or implied including any warranty of merchantability or fitness for a particular purpose (including, but not limited to, use in life support applications, where malfunctions of product can cause injury to a person's health or life).

## Quality

### Reliability

According to MIL-HDBK-217F the calculated MTBF value at 100% load (from PKV 5211 PI) at the following ambient temperatures will be approx.:

$T_{amb}$	Hours
0 °C	2.7 million
10 °C	1.5 million
25 °C	650 000
40 °C	276 000
60 °C	88 000
75 °C	37 000

At 80–100% load the case temperature will be approx. 15–20 °C higher than the ambient temperature.

### Quality Statement

The products are designed and manufactured in an industrial environment where quality systems and methods like ISO 9000 and SPC are intensively in use to boost the continuous improvements strategy. Infant mortality or early failures in the products are screened out by a burn-in procedure.

### Warranty

Ericsson Microelectronics warrants to the original purchaser or end user that the product conform to this Data Sheet and are free from material and workmanship defects for a period of five (5) years from the date of manufacture, if the product is used within specified conditions and not opened. In case the product is discontinued, claims will be accepted up to three (3) years from the date of the discontinuation. For additional details on this limited warranty we refer to Ericsson Microelectronics AB's "General Terms and Conditions of Sales", or individual contract documents.

Information given in this data sheet is believed to be accurate and reliable. No responsibility is assumed for the consequences of its use nor for any infringement of patents or other rights of third parties which may result from its use. No license is granted by implication or otherwise under any patent or patent rights of Ericsson Microelectronics. These products are sold only according to Ericsson Microelectronics' general conditions of sale, unless otherwise confirmed in writing. Specifications subject to change without notice.

## Product Program

$V_i$	$V_o/I_o$ max	$P_o$ max	Ordering No.
12/24 V	3.3 V/500 mA	1.65 W	PKV 3110 PI
	5 V/500 mA	2.50 W	PKV 3211 PI
	12 V/250 mA	3.00 W	PKV 3313 PI
	15 V/200 mA	3.00 W	PKV 3315 PI
	± 5V/250 mA	2.50 W	PKV 3222 PI
	±12V/125 mA	3.00 W	PKV 3321 PI
	±15V/100 mA	3.00 W	PKV 3325 PI
48/60 V	3.3 V/500 mA	1.65 W	PKV 5110 PI
	5 V/500 mA	2.50 W	PKV 5211 PI
	12 V/250 mA	3.00 W	PKV 5313 PI
	15 V/200 mA	3.00 W	PKV 5315 PI
	± 5 V/250 mA	2.50 W	PKV 5222 PI
	±12 V/125 mA	3.00 W	PKV 5321 PI
	±15 V/100 mA	3.00 W	PKV 5325 PI

Ericsson Microelectronics AB  
 SE-164 81 KISTA, Sweden  
 Phone: +46 8 757 5000  
[www.ericsson.com/microelectronics](http://www.ericsson.com/microelectronics)

For local sales contacts, please refer to our website  
 or call: Int. +46 8 757 4700, Fax: +46 8 757 4776

The latest and most complete information  
 can be found on our website!

Data Sheet

EN/LZT 146 37 R1A (Replaces EN/LZT 137 33 R1A)  
 © Ericsson Microelectronics AB, June 2000