



Chokes and inductors

For high frequency and EMC
RF chokes, HLBC series

Series/Type: **B82145**
Date: November 2005

HLBC choke (High-Current Large Bobbin Core)

Rated current 110 to 860 mA

Rated inductance 100 to 10 000 μ H

Construction

- Large ferrite drum core
- Winding: enamel copper wire
- Flame-retardant lacquer coating

Features

- High rated current at high inductance ratings
- RoHS-compatible (see page 5)

Applications

- Decoupling
- Interference suppression
- For energy-saving lamps and entertainment electronics

Terminals

- Central axial leads, lead-free tinned

Marking

Inductance indicated by color bands to IEC 60062

Delivery mode

Taped and reeled (packing see page 7)

Dimensional drawing

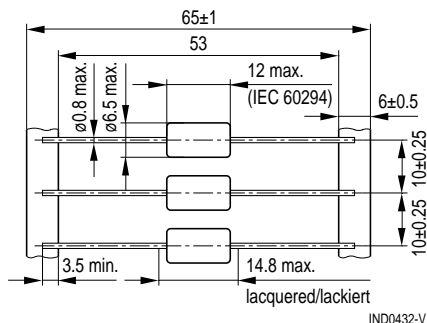

Minimum lead spacing 15 mm

Approx. weight 1.3 g

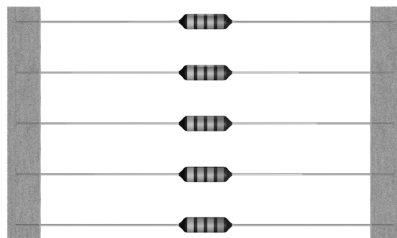

Characteristics and ordering codes

For further technical data see page 5.

L_R μH	Tolerance ¹⁾	Q_{\min}	f_Q MHz	I_R mA	R_{\max} Ω	$f_{\text{res, min}}$ MHz	Ordering code
100	$\pm 5\%$ $\triangleq J$	50	0.796	860	0.70	3.5	B82145A1104J000
150		40	0.796	770	0.90	3.0	B82145A1154J000
220		30	0.796	690	1.10	2.5	B82145A1224J000
330		30	0.796	630	1.30	2.1	B82145A1334J000
470		30	0.796	510	1.90	1.8	B82145A1474J000
680		20	0.796	440	2.50	1.5	B82145A1684J000
1000		60	0.252	370	3.60	1.3	B82145A1105J000
1500		60	0.252	300	5.40	1.0	B82145A1155J000
2200		60	0.252	250	8.00	0.8	B82145A1225J000
3300		60	0.252	200	12.5	0.6	B82145A1335J000
4700	60	0.252	170	18.0	0.5	B82145A1475J000	
6800	60	0.252	130	28.5	0.4	B82145A1685J000	
10000	50	0.0796	110	35.0	0.35	B82145A1106J000	

HLBC chokes with diameter 7.5 and 8.5 mm for even higher rated currents available upon request.

1) Closer tolerances upon request.

Impedance $|Z|$
 versus frequency f
 measured with impedance analyzer
 HP 4191A / HP 4194A

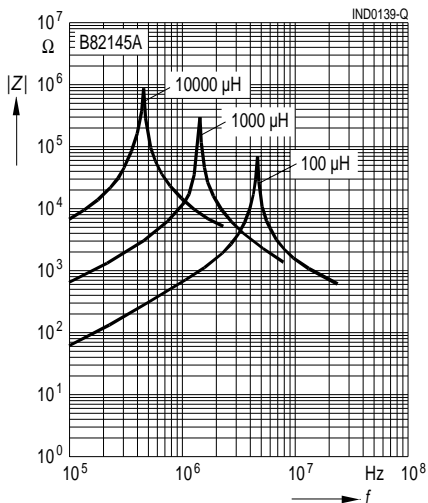

Inductance L
 versus DC load current I_{DC}
 measured with LCR meter
 HP 4275A

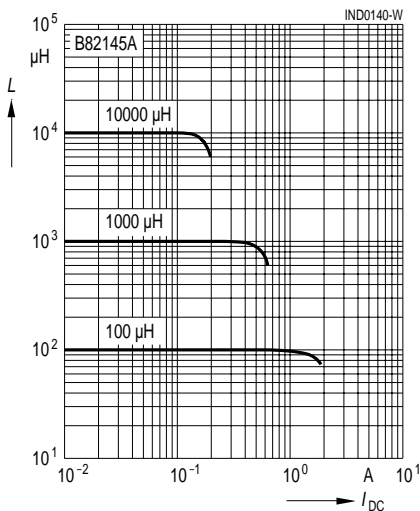

Q factor
 versus frequency f
 measured with impedance analyzer
 HP 4194A

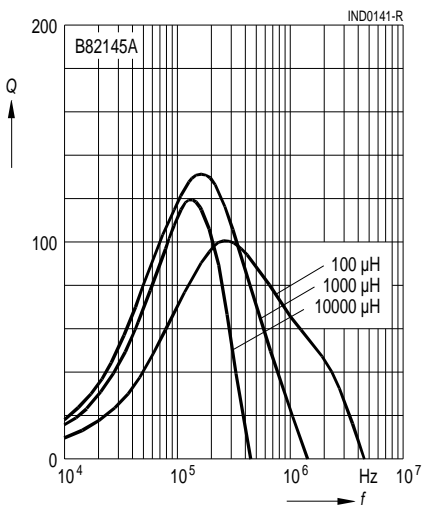

Current derating I_{op}/I_R
 versus ambient temperature T_A
 (rated temperature $T_R = 40\text{ °C}$)

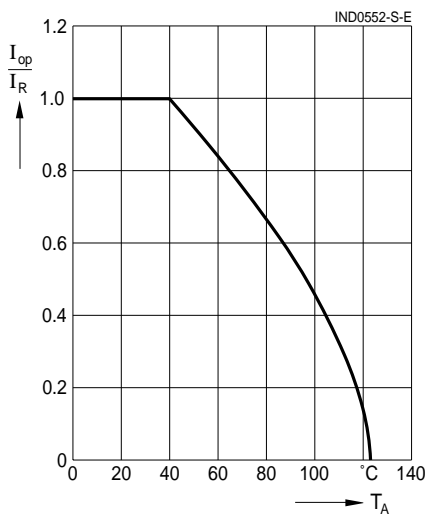

General technical data

Rated inductance L_R	Measuring frequency: $L \leq 10 \mu\text{H}$ = 1 MHz $10 \mu\text{H} < L \leq 4700 \mu\text{H}$ = 100 kHz $L > 4700 \mu\text{H}$ = 10 kHz Measuring current: $\leq 1 \text{ mA}$ Distance between measuring clamps: 25.4 mm
Q factor Q_{\min}	Measured with HP 4342A
Rated current I_R	Maximum permissible DC current referred to 40 °C ambient temperature, for derating see below
Inductance decrease $\Delta L/L_0$	$\leq 10\%$ (referred to initial value) at I_R at 20 °C ambient temperature
DC resistance R_{\max}	Measured at 20 °C ambient temperature, distance between measuring clamps: 25.4 mm
Resonance frequency $f_{\text{res, min}}$	Measured with Scalar Network Analyzer ZAS from Rohde & Schwarz
Climatic category	55/125/56 (-55 °C/+125 °C/56 days damp heat test) to IEC 60068-1
Solderability	235 °C, 2 s, $\geq 90\%$ wetting to IEC 60068-2-20, test Ta
Resistance to soldering heat	To IEC 60068-2-20, test Tb 260 °C, 10 s
Tensile strength of leads	To IEC 60068-2-21, test Ua $\geq 20 \text{ N}$
RoHS-compatible	RoHS-compatible is defined as compatible with the following documents: DIRECTIVE 2002/95/EC OF THE EUROPEAN PARLIAMENT AND OF THE COUNCIL of 13 February 2003 on the restriction of the use of certain hazardous substances in electrical and electronic equipment COM (2004) 606 final Proposal for a COUNCIL DECISION amending Directive 2002/95/EC of the European Parliament and of the Council for the purposes of establishing the maximum concentration values for certain hazardous substances in electrical and electronic equipment.
 Mounting information	When bending the leads, take care that the start-of-winding areas at the face ends (protected by glue and lacquer) are not subjected to any mechanical stress.

Color coding of the inductance value

The inductance value and tolerance are encoded by means of colored bands in accordance with IEC 60062. The basic unit is μH .

1st band 1st digit of inductance value

2nd band 2nd digit of inductance value

3rd band multiplier, i.e. the power of ten, by which the first two digits have to be multiplied.

4th band tolerance of the inductance value.

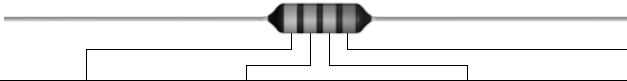

Color code	1 st band = 1 st digit	2 nd band = 2 nd digit	3 rd band = multiplier	4 th band = tolerance
Colorless	—	—	—	$\pm 20\%$ (M)
Silver	—	—	$\times 10^{-2} \mu\text{H} =$	$0.01 \mu\text{H}$ $\pm 10\%$ (K)
Gold	—	—	$\times 10^{-1} \mu\text{H} =$	$0.1 \mu\text{H}$ $\pm 5\%$ (J)
Black	—	0	$\times 10^0 \mu\text{H} =$	$1 \mu\text{H}$ —
Brown	1	1	$\times 10^1 \mu\text{H} =$	$10 \mu\text{H}$ —
Red	2	2	$\times 10^2 \mu\text{H} =$	$100 \mu\text{H}$ $\pm 2\%$ (G)
Orange	3	3	$\times 10^3 \mu\text{H} =$	$1000 \mu\text{H}$ —
Yellow	4	4	$\times 10^4 \mu\text{H} =$	$10000 \mu\text{H}$ —
Green	5	5	$\times 10^5 \mu\text{H} =$	$100000 \mu\text{H}$ —
Blue	6	6		Special designs manufactured to customer specifica- tions are identified by a white tolerance band.
Violet	7	7		
Grey	8	8		
White	9	9		

Examples:

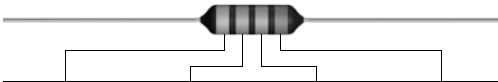

1 st band	2 nd band	3 rd band	4 th band	Decoding
Yellow 4	Violet 7	Gold $\times 0.1 \mu\text{H}$	Silver $\pm 10\%$	$= 47 \times 0.1 \mu\text{H} \pm 10\% = 4.7 \mu\text{H} \pm 10\%$
Brown 1	Green 5	Red $\times 100 \mu\text{H}$	Gold $\pm 5\%$	$= 15 \times 100 \mu\text{H} \pm 5\% = 1500 \mu\text{H} \pm 5\%$

Taping and packing

Reel packing

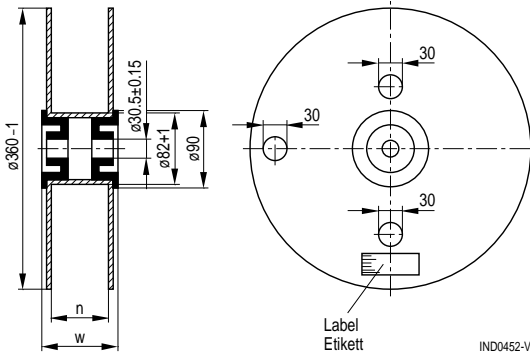

	Axial
n (mm)	72 +1
w (mm)	84 max.

Packing unit: 1250 pcs./reel

Important notes

The following applies to all products named in this publication:

1. Some parts of this publication contain **statements about the suitability of our products for certain areas of application**. These statements are based on our knowledge of typical requirements that are often placed on our products in the areas of application concerned. We nevertheless expressly point out **that such statements cannot be regarded as binding statements about the suitability of our products for a particular customer application**.

As a rule, EPCOS is either unfamiliar with individual customer applications or less familiar with them than the customers themselves. For these reasons, it is always ultimately incumbent on the customer to check and decide whether an EPCOS product with the properties described in the product specification is suitable for use in a particular customer application.

2. We also point out that in **individual cases, a malfunction of passive electronic components or failure before the end of their usual service life cannot be completely ruled out in the current state of the art, even if they are operated as specified**. In customer applications requiring a very high level of operational safety and especially in customer applications in which the malfunction or failure of a passive electronic component could endanger human life or health (e.g. in accident prevention or life-saving systems), it must therefore be ensured by means of suitable design of the customer application or other action taken by the customer (e.g. installation of protective circuitry or redundancy) that no injury or damage is sustained by third parties in the event of malfunction or failure of a passive electronic component.

3. **The warnings, cautions and product-specific notes must be observed.**

4. In order to satisfy certain technical requirements, **some of the products described in this publication may contain substances subject to restrictions in certain jurisdictions (e.g. because they are classed as “hazardous”)**. Useful information on this will be found in our Material Data Sheets on the Internet (www.epcos.com/material). Should you have any more detailed questions, please contact our sales offices.

5. We constantly strive to improve our products. Consequently, **the products described in this publication may change from time to time**. The same is true of the corresponding product specifications. Please check therefore to what extent product descriptions and specifications contained in this publication are still applicable before or when you place an order.

We also **reserve the right to discontinue production and delivery of products**. Consequently, we cannot guarantee that all products named in this publication will always be available.

6. Unless otherwise agreed in individual contracts, **all orders are subject to the current version of the “General Terms of Delivery for Products and Services in the Electrical Industry” published by the German Electrical and Electronics Industry Association (ZVEI)**.

7. The trade names EPCOS, CeraDiode, CSSP, PhaseCap, PhaseMod, SilverCap, SIFI, SIMID, SIKOREL, SIOV, SIP5D, SIP5K, TOPcap, UltraCap, WindCap are **trademarks registered or pending** in Europe and in other countries. Further information will be found on the Internet at www.epcos.com/trademarks.