

### Features

1. High sensitivity.
2. TTL and LSTTL compatible output.
3. Operating supply voltage range.  
(Vcc 4.5V to 17V)
4. Output form pull-up resistor built-in type.
5. Low output current dissipation.  
(Iccl : MAX. 3.8mA)
6. High isolation voltage between input and output  
(Viso : 5000Vrms).
7. Available package : DIP/ SMD/ H. (For Package Dimension please refer to page 82 )

### Applications

1. Computer terminals.
2. High speed line receivers.
3. Interfaces with various data transmission equipment.
4. Switching regulators.

### Outside Dimension : Unit (mm)

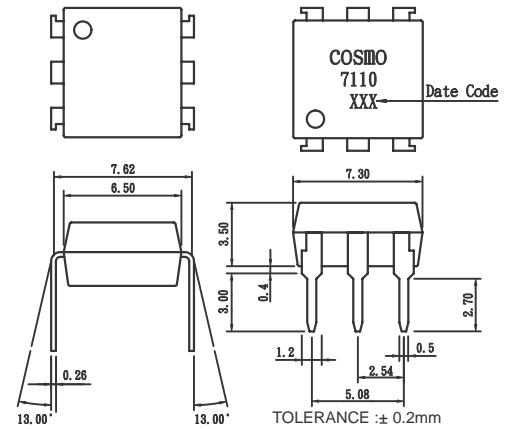

### Schematic : Top View

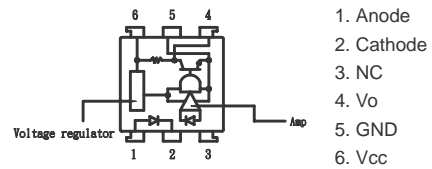

### Absolute Maximum Ratings

(Ta=25°C)

Parameter		Symbol	Rating	Unit
Input	Forward current	IF	50	mA
	Peak forward current	IFM	1	A
	Reverse voltage	VR	6	V
	Power dissipation	Pd	70	mW
Output	Supply voltage	VCC	-0.5+0.17	A
	Output current	Io	50	A
	Power dissipation	Pd	150	mW
Total power dissipation		Ptot	170	mW
Isolation voltage 1 minute		Viso	5000	Vrms
Operating temperature		Topr	-25 to +85	°C
Storage temperature		Tstg	-40 to +125	°C
Soldering temperature		Tsol	260	°C

### Electro-optical Characteristics

(Ta=25°C)

Parameter		Symbol	Conditions	MIN.	TYP.	MAX.	Unit	
Input	Forward voltage	VF	IF =10mA	—	1.2	1.4	V	
	Peak forward voltage	VFM	IFM =0.5A	—	—	3.5	V	
	Reverse current	IR	VR =4V	—	—	10	uA	
	Terminal capacitance	Ct	V =0, f=1kHz	—	30	—	pF	
Output	Operating supply voltage	VCC		4.5	—	17	V	
	Low level output voltage	VOL	IOL =16mA, VCC=5V, IF=4mA	—	0.15	0.4	V	
	High level output voltage	VOH	VCC =5V, IF=0	3.5	—	—	V	
	Low level supply current	ICCL	VCC =5V, IF=1mA	—	1.7	3.8	mA	
	High level supply current	ICCH	VCC =5V, IF=0	—	0.7	2.2	mA	
Transfer characteristics	"High-Low" Threshold input current	IFHL	VCC =5V, RL=280ohm	—	0.5	1.0	mA	
	" Low-High " Threshold input current	IFLH	VCC =5V, RL=280ohm	0.1	0.4	—	mA	
	Hysteresis	IFLH /IFHL	VCC =5V, RL=280ohm	—	0.8	—	—	
	Isolation resistance	Riso	Ta =25°C, DC500V	5x10 <sup>10</sup>	10 <sup>11</sup>	—	ohm	
	Response time	"High-Low" propagation delay time	tPHL	Ta=25°C, Vcc=5V, IF =1mA, RL =280ohm	—	3	9	us
		" Low -High " propagation delay time	tPLH		—	5	15	
		Fall time	tf		—	0.05	0.5	
Rise time		tr	—		0.1	0.5		

**Fig.1** Low Level Output Current vs. Ambient Temperature

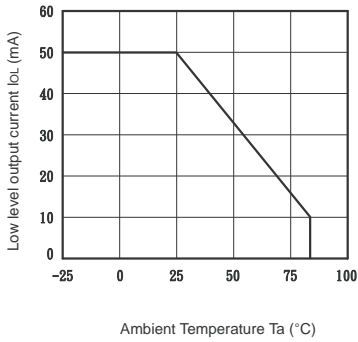

**Fig.2** Power Dissipation vs. Ambient Temperature

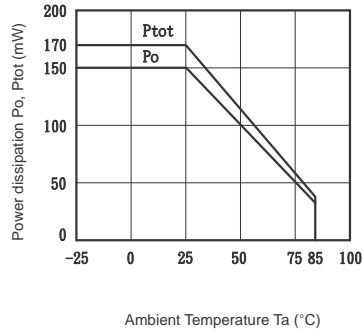

**Fig.3** Rise Time, Fall Time vs. Load Resistance

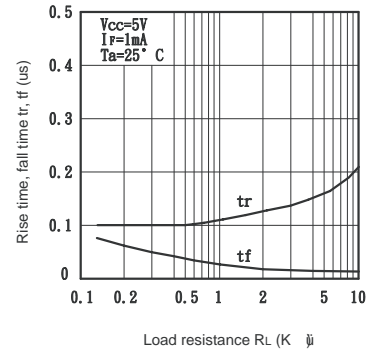

**Fig.4** Forward Current vs. Forward Voltage

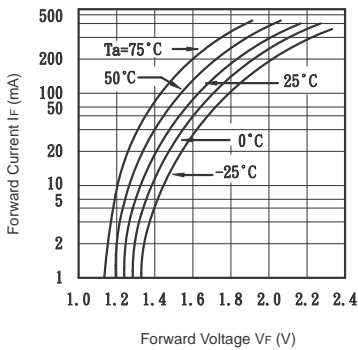

**Fig.5** Supply Current vs. Ambient Temperature

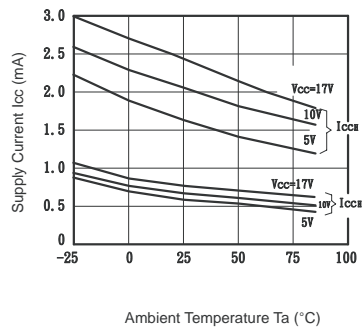

**Fig.6** Low Level Output Voltage vs. Ambient Temperature

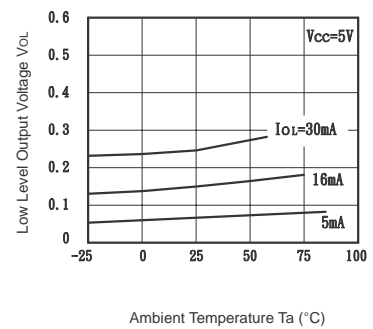

**Fig.7** Propagation Delay Time vs. Forward Current

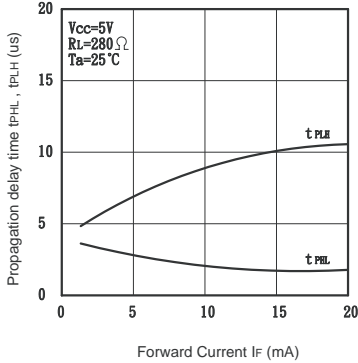

**Fig.8** Low Level Output Voltage vs. Low Level Output Current

