

Cascadable Silicon Bipolar MMIC Amplifier

Technical Data

MSA-0104

Features

- **Cascadable 50 Ω Gain Block**
- **3 dB Bandwidth:**
DC to 0.8 GHz
- **High Gain:**
17.0 dB Typical at 0.5 GHz
- **Unconditionally Stable**
($k > 1$)
- **Low Cost Plastic Package**

Description

The MSA-0104 is a high performance silicon bipolar Monolithic Microwave Integrated Circuit (MMIC) housed in a low cost plastic package. This MMIC is

designed for use as a general purpose 50 Ω gain block. Typical applications include narrow and wide bandwidth IF and RF amplifiers in commercial and industrial applications.

The MSA-series is fabricated using HP's 10 GHz f_T , 25 GHz f_{MAX} , silicon bipolar MMIC process which uses nitride self-alignment, ion implantation, and gold metallization to achieve excellent performance, uniformity and reliability. The use of an external bias resistor for temperature and current stability also allows bias flexibility.

04A Plastic Package

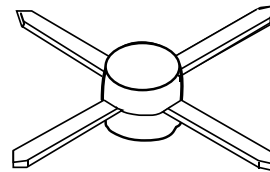

Typical Biasing Configuration

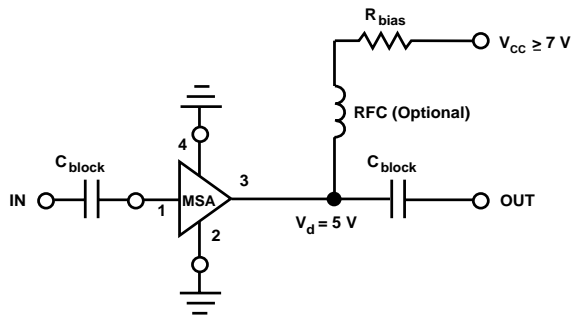

MSA-0104 Absolute Maximum Ratings

Parameter	Absolute Maximum ^[1]
Device Current	40 mA
Power Dissipation ^[2,3]	200 mW
RF Input Power	+13 dBm
Junction Temperature	150°C
Storage Temperature	-65 to 150°C

Thermal Resistance^[2,4]:

$$\theta_{jc} = 100^{\circ}\text{C/W}$$

Notes:

1. Permanent damage may occur if any of these limits are exceeded.
2. $T_{\text{CASE}} = 25^{\circ}\text{C}$.
3. Derate at 10 mW/°C for $T_{\text{C}} > 130^{\circ}\text{C}$.
4. See MEASUREMENTS section "Thermal Resistance" for more information.

MSA-0104 Electrical Specifications^[1], $T_{\text{A}} = 25^{\circ}\text{C}$

Symbol	Parameters and Test Conditions: $I_{\text{d}} = 17 \text{ mA}$, $Z_{\text{O}} = 50 \Omega$	Units	Min.	Typ.	Max.
G_{P}	Power Gain ($ S_{21} ^2$) f = 0.1 GHz f = 0.5 GHz	dB	17.0	18.5 17.0	
ΔG_{P}	Gain Flatness f = 0.1 to 0.6 GHz	dB		± 1.0	
$f_{3 \text{ dB}}$	3 dB Bandwidth	GHz		0.8	
VSWR	Input VSWR f = 0.1 to 3.0 GHz			1.4:1	
	Output VSWR f = 0.1 to 3.0 GHz			1.3:1	
NF	50 Ω Noise Figure f = 0.5 GHz	dB		5.5	
$P_{1 \text{ dB}}$	Output Power at 1 dB Gain Compression f = 0.5 GHz	dBm		1.5	
IP_3	Third Order Intercept Point f = 0.5 GHz	dBm		14.0	
t_{D}	Group Delay f = 0.5 GHz	psec		180	
V_{d}	Device Voltage	V	4.5	5.0	5.5
dV/dT	Device Voltage Temperature Coefficient	mV/°C		-9.0	

Notes:

1. The recommended operating current range for this device is 13 to 25 mA. Typical performance as a function of current is on the following page.

MSA-0104 Typical Scattering Parameters ($Z_{\text{O}} = 50 \Omega$, $T_{\text{A}} = 25^{\circ}\text{C}$, $I_{\text{d}} = 17 \text{ mA}$)

Freq. GHz	S_{11}		S_{21}			S_{12}			S_{22}	
	Mag	Ang	dB	Mag	Ang	dB	Mag	Ang	Mag	Ang
0.1	.06	141	18.4	8.31	170	-22.3	.077	5	.07	-9
0.2	.08	112	18.1	8.07	160	-22.3	.077	9	.07	-15
0.3	.10	94	17.8	7.75	151	-22.0	.079	15	.07	-22
0.4	.12	77	17.4	7.38	142	-21.6	.083	16	.07	-32
0.5	.13	70	16.9	7.01	134	-21.0	.089	19	.07	-37
0.6	.14	56	16.4	6.60	127	-20.7	.092	21	.08	-44
0.8	.16	41	15.4	5.87	114	-19.5	.106	27	.08	-53
1.0	.17	28	14.3	5.21	102	-18.9	.114	29	.08	-61
1.5	.17	5	12.1	4.02	78	-16.6	.148	30	.08	-73
2.0	.13	-12	10.2	3.25	59	-14.9	.179	25	.07	-90
2.5	.08	-20	8.9	2.77	46	-13.6	.209	25	.05	-112
3.0	.02	-37	7.7	2.42	31	-12.7	.232	18	.05	-134
3.5	.05	128	6.7	2.15	15	-11.9	.253	10	.06	-160
4.0	.12	113	5.7	1.92	-1	-11.3	.272	2	.06	-175
4.5	.19	97	4.8	1.73	-15	-10.8	.289	-7	.07	173
5.0	.27	80	3.9	1.56	-30	-10.6	.294	-15	.07	150

A model for this device is available in the DEVICE MODELS section.

MSA-0104 Typical Performance, $T_A = 25^\circ\text{C}$

(unless otherwise noted)

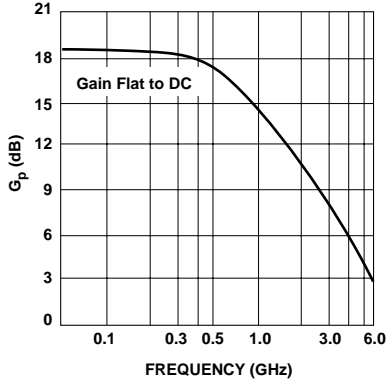

Figure 1. Typical Power Gain vs. Frequency, $T_A = 25^\circ\text{C}$, $I_d = 17\text{ mA}$.

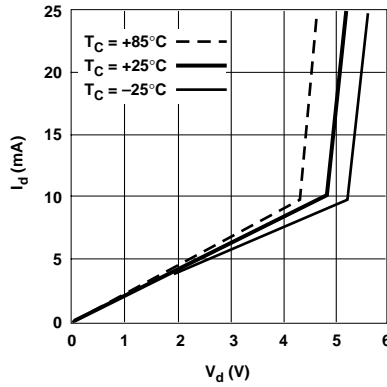

Figure 2. Device Current vs. Voltage.

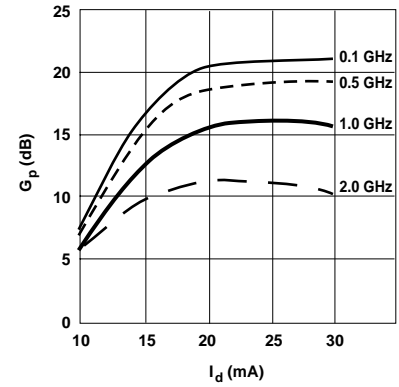

Figure 3. Power Gain vs. Current.

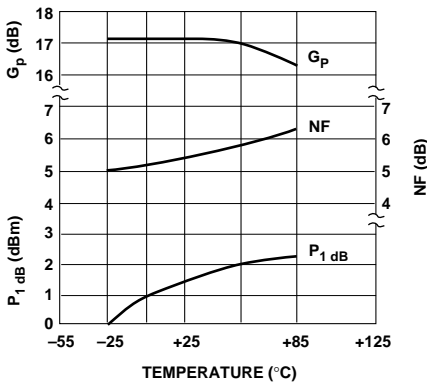

Figure 4. Output Power at 1 dB Gain Compression, NF and Power Gain vs. Case Temperature, $f = 0.5\text{ GHz}$, $I_d = 17\text{ mA}$.

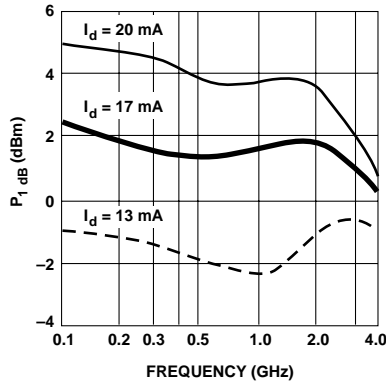

Figure 5. Output Power at 1 dB Gain Compression vs. Frequency.

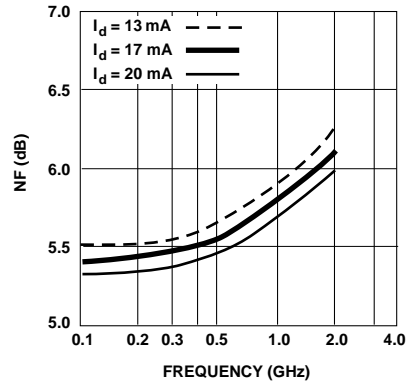

Figure 6. Noise Figure vs. Frequency.

04A Plastic Package Dimensions

