



Dual N-Channel 30-V (D-S) MOSFET with Schottky Diode

PRODUCT SUMMARY		
V_{DS} (V)	$r_{DS(on)}$ (Ω)	I_D (A)
30	0.022 @ $V_{GS} = 10$ V	7.5
	0.030 @ $V_{GS} = 4.5$ V	6.5

SCHOTTKY PRODUCT SUMMARY		
V_{DS} (V)	V_{SD} (V) Diode Forward Voltage	I_F (A)
30	0.50 V @ 1.0 A	2.0

FEATURES

- TrenchFET® Power MOSFET
- PWM Optimized
- 100% R_g Tested

APPLICATIONS

- Symmetrical Buck-Boost DC/DC Converter

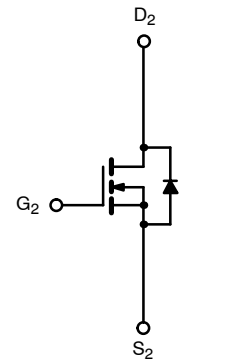
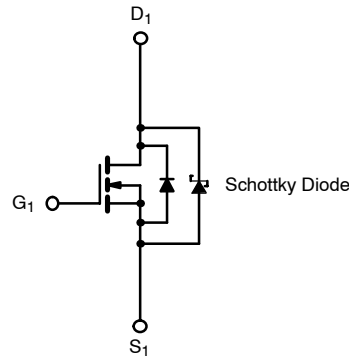
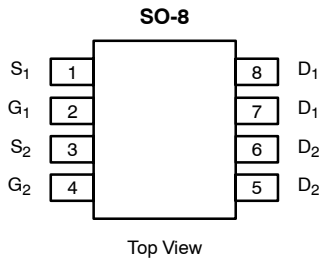

Ordering Information: Si4834BDY—E3 (Lead Free)
Si4834BDY:T1—E3 (Lead Free with Tape and Reel)

N-Channel MOSFET

N-Channel MOSFET

ABSOLUTE MAXIMUM RATINGS ($T_A = 25^\circ\text{C}$ UNLESS OTHERWISE NOTED)				
Parameter	Symbol	10 secs	Steady State	Unit
Drain-Source Voltage	V_{DS}	30		V
Gate-Source Voltage	V_{GS}	± 20		
Continuous Drain Current ($T_J = 150^\circ\text{C}$) ^a	I_D	$T_A = 25^\circ\text{C}$	7.5	5.7
		$T_A = 70^\circ\text{C}$	6.0	4.6
Pulsed Drain Current	I_{DM}	30		A
Continuous Source Current (Diode Conduction) ^a	I_S	1.7	0.9	
Maximum Power Dissipation ^a	P_D	$T_A = 25^\circ\text{C}$	2.0	1.1
		$T_A = 70^\circ\text{C}$	1.3	0.7
Operating Junction and Storage Temperature Range	T_J, T_{stg}	-55 to 150		$^\circ\text{C}$

THERMAL RESISTANCE RATINGS						
Parameter	Symbol	MOSFET		Schottky		Unit
		Typ	Max	Typ	Max	
Maximum Junction-to-Ambient ^a	R_{thJA}	$t \leq 10$ sec	52	62.5	53	62.5
		Steady-State	93	110	93	110
Maximum Junction-to-Foot (Drain)	R_{thJF}	35	40	35	40	$^\circ\text{C/W}$

Notes
a. Surface Mounted on 1" x 1" FR4 Board.



MOSFET SPECIFICATIONS (T_J = 25 °C UNLESS OTHERWISE NOTED).							
Parameter	Symbol	Test Condition	Min	Typ ^a	Max	Unit	
Static							
Gate Threshold Voltage	V _{GS(th)}	V _{DS} = V _{GS} , I _D = 250 μA	0.8		3.0	V	
Gate-Body Leakage	I _{GSS}	V _{DS} = 0 V, V _{GS} = ±20 V			±100	nA	
Zero Gate Voltage Drain Current	I _{DSS}	V _{DS} = 30 V, V _{GS} = 0 V	Ch-1		100	μA	
			Ch-2		1		
		V _{DS} = 30 V, V _{GS} = 0 V, T _J = 85 °C	Ch-1		2000		
			Ch-2		15		
On-State Drain Current ^b	I _{D(on)}	V _{DS} = 5 V, V _{GS} = 10 V	20			A	
Drain-Source On-State Resistance ^b	r _{DS(on)}	V _{GS} = 10 V, I _D = 7.5 A		0.017	0.022	Ω	
		V _{GS} = 4.5 V, I _D = 6.5 A		0.024	0.030		
Forward Transconductance ^b	g _{fs}	V _{DS} = 15 V, I _D = 7.5 A		19		S	
Diode Forward Voltage ^b	V _{SD}	I _S = 1 A, V _{GS} = 0 V	Ch-1		0.47	0.5	V
			Ch-2		0.75	1.2	
Dynamic^a							
Total Gate Charge	Q _g	V _{DS} = 15 V, V _{GS} = 4.5 V, I _D = 7.5 A		7	11	nC	
Gate-Source Charge	Q _{gs}			2.9			
Gate-Drain Charge	Q _{gd}			2.5			
Gate Resistance	R _g		0.5	1.5	2.6	Ω	
Turn-On Delay Time	t _{d(on)}	V _{DD} = 15 V, R _L = 15 Ω I _D ≅ 1 A, V _{GEN} = 10 V, R _g = 6 Ω		9	15	ns	
Rise Time	t _r			10	17		
Turn-Off Delay Time	t _{d(off)}			19	30		
Fall Time	t _f			9	15		
Source-Drain Reverse Recovery Time	t _{rr}	I _F = 1.7 A, di/dt = 100 A/μs	Ch-1		32	55	
			Ch-2		35	55	

Notes

- a. Guaranteed by design, not subject to production testing.
- b. Pulse test; pulse width ≤ 300 μs, duty cycle ≤ 2%.

SCHOTTKY SPECIFICATIONS (T_J = 25 °C UNLESS OTHERWISE NOTED)						
Parameter	Symbol	Test Condition	Min	Typ	Max	Unit
Forward Voltage Drop	V _F	I _F = 1.0 A		0.47	0.50	V
		I _F = 1.0 A, T _J = 125 °C		0.36	0.42	
Maximum Reverse Leakage Current	I _{rm}	V _r = 30 V		0.004	0.100	mA
		V _r = 30 V, T _J = 100 °C		0.7	10	
		V _r = -30 V, T _J = 125 °C		3.0	20	
Junction Capacitance	C _T	V _r = 10 V		50		pF



TYPICAL CHARACTERISTICS (25°C UNLESS NOTED)

MOSFET

Output Characteristics

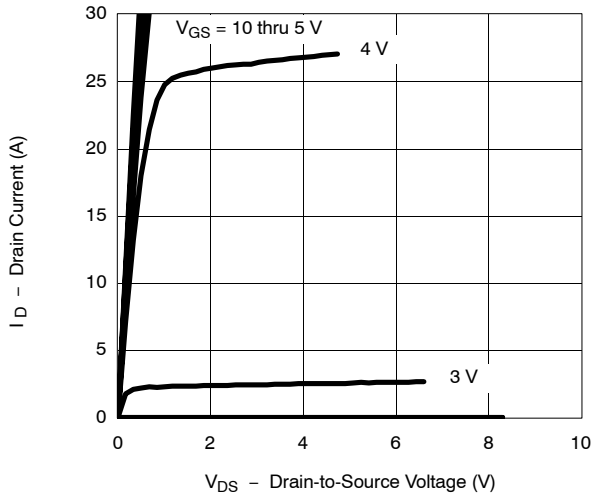

Transfer Characteristics

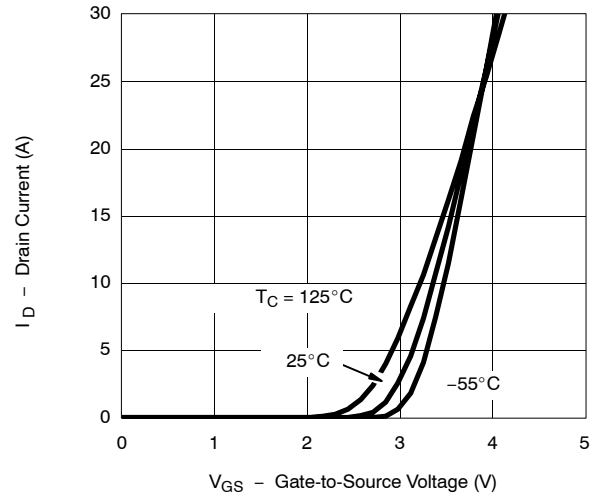

On-Resistance vs. Drain Current

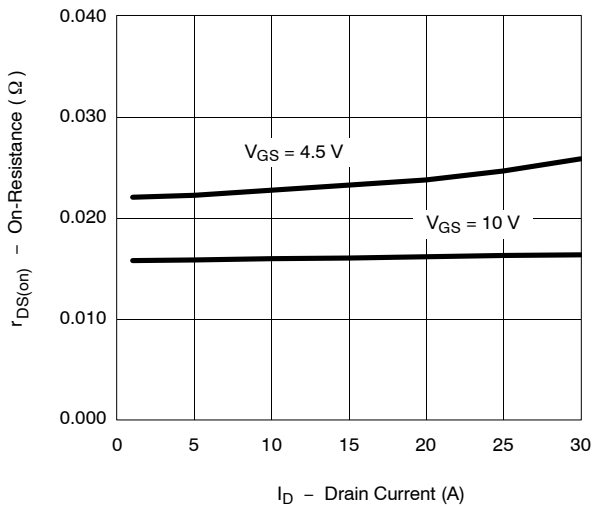

Capacitance

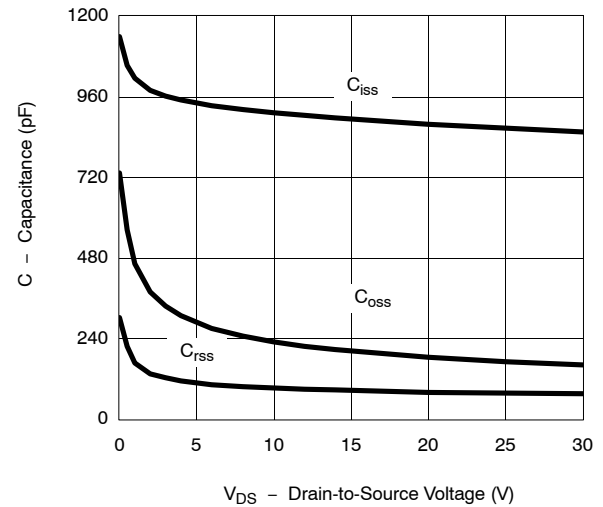

Gate Charge

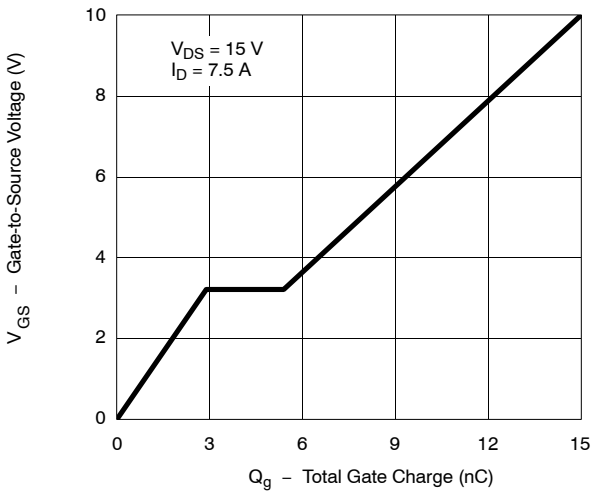

On-Resistance vs. Junction Temperature

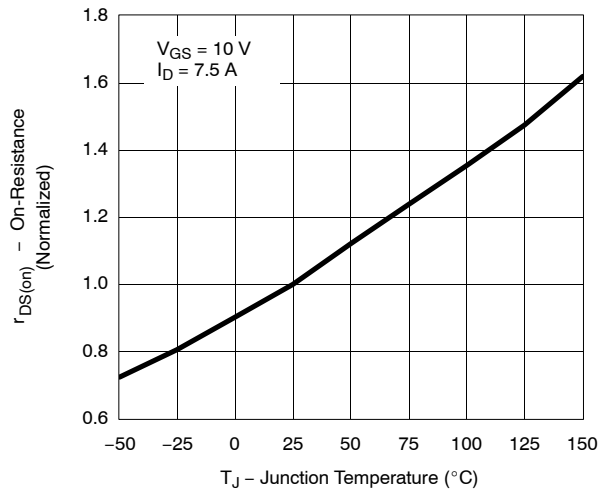

TYPICAL CHARACTERISTICS (25 °C UNLESS NOTED) MOSFET

Source-Drain Diode Forward Voltage

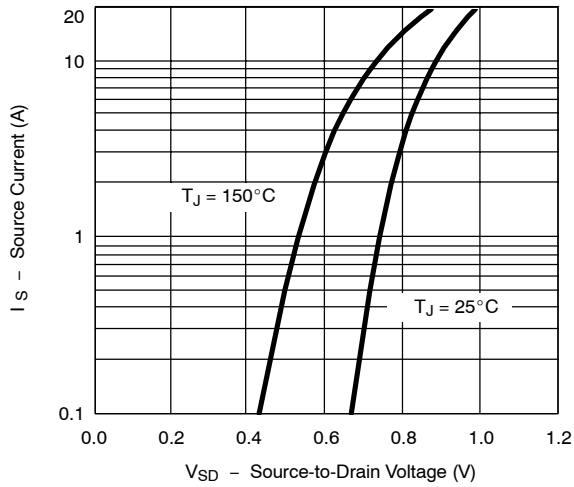

On-Resistance vs. Gate-to-Source Voltage

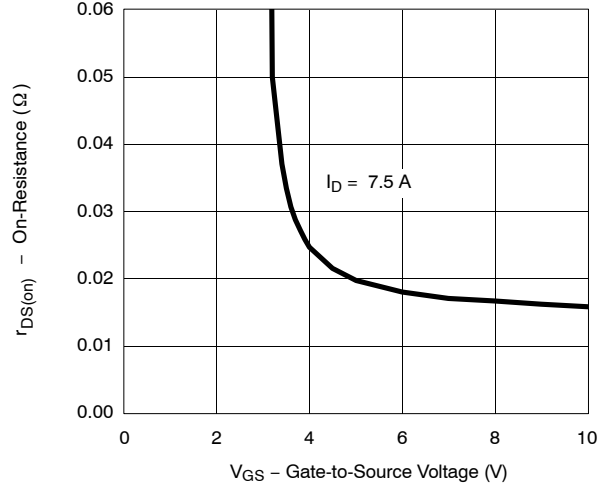

Threshold Voltage

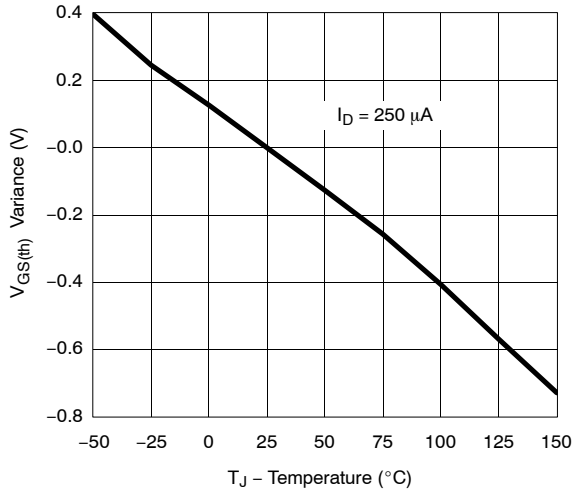

Single Pulse Power, Junction-to-Ambient

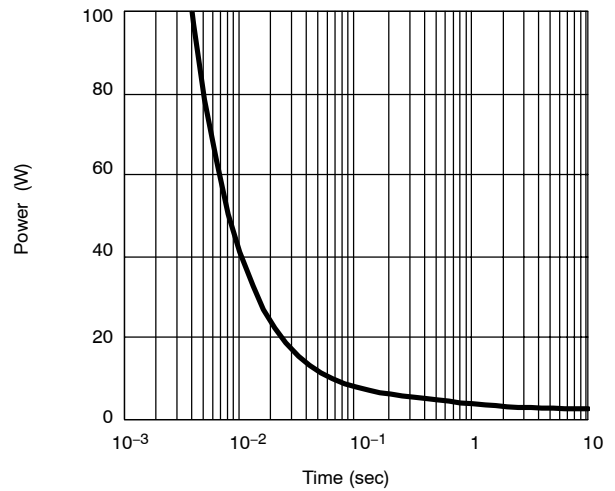

Safe Operating Area, Junction-to-Foot

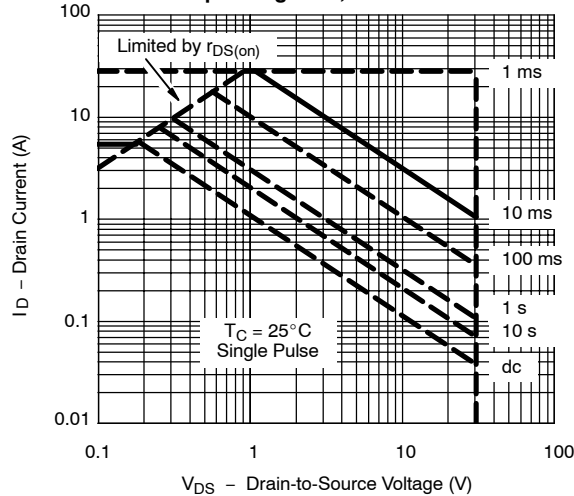



TYPICAL CHARACTERISTICS (25 °C UNLESS NOTED) MOSFET

Normalized Thermal Transient Impedance, Junction-to-Ambient

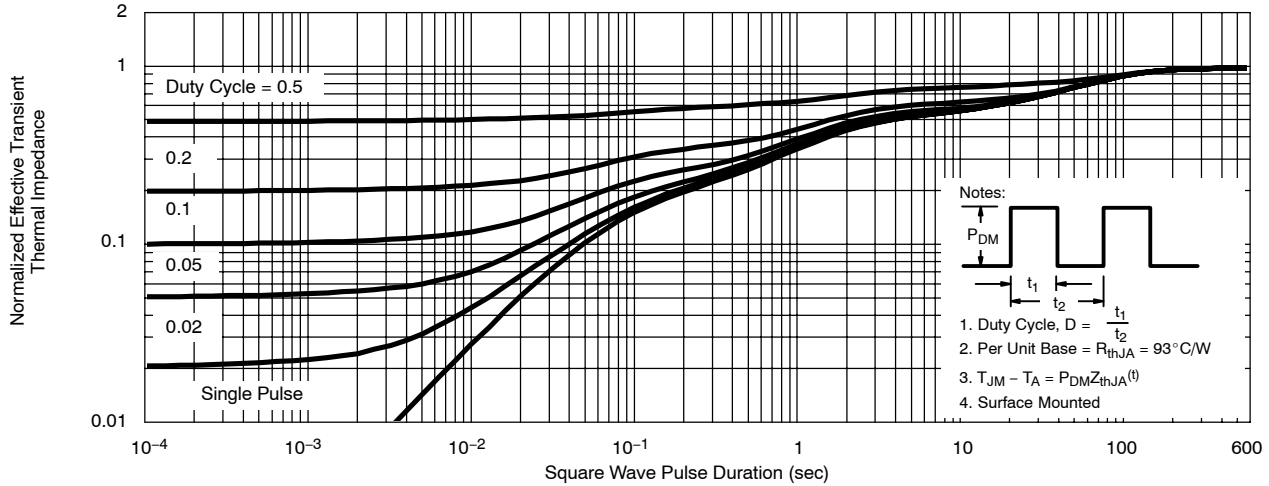

Normalized Thermal Transient Impedance, Junction-to-Foot

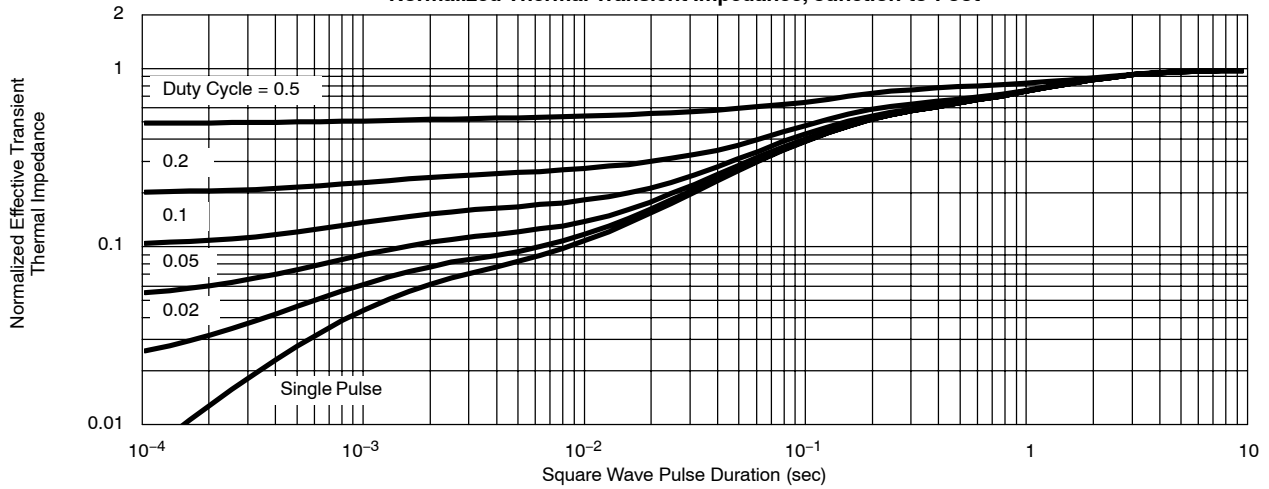

TYPICAL CHARACTERISTICS (25 °C UNLESS NOTED) SCHOTTKY

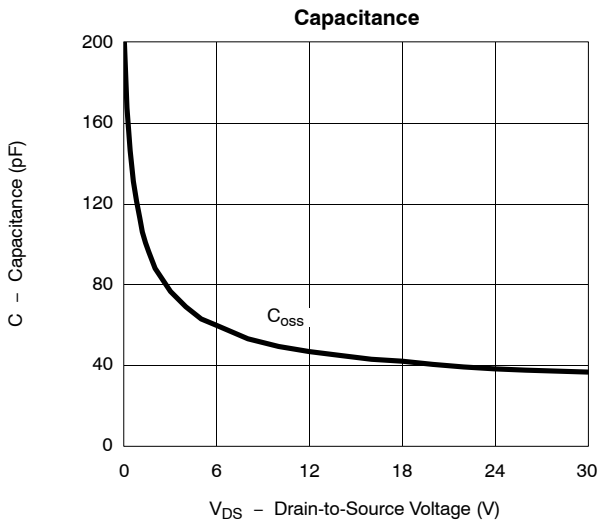
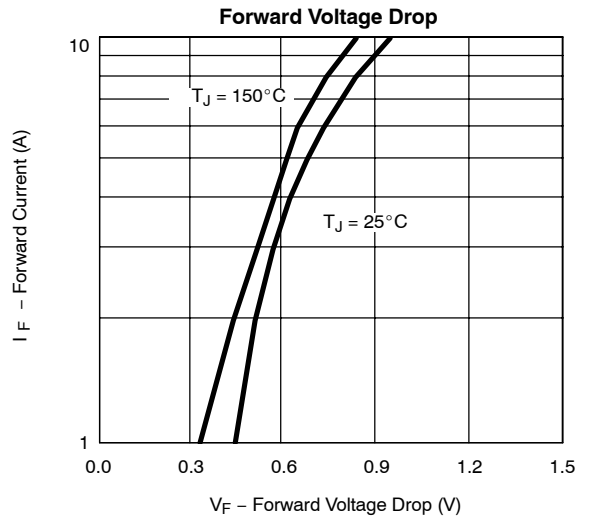
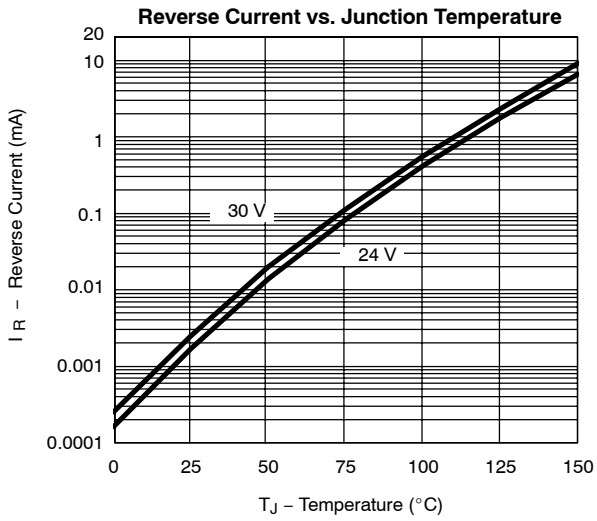



Notice

Specifications of the products displayed herein are subject to change without notice. Vishay Intertechnology, Inc., or anyone on its behalf, assumes no responsibility or liability for any errors or inaccuracies.

Information contained herein is intended to provide a product description only. No license, express or implied, by estoppel or otherwise, to any intellectual property rights is granted by this document. Except as provided in Vishay's terms and conditions of sale for such products, Vishay assumes no liability whatsoever, and disclaims any express or implied warranty, relating to sale and/or use of Vishay products including liability or warranties relating to fitness for a particular purpose, merchantability, or infringement of any patent, copyright, or other intellectual property right.

The products shown herein are not designed for use in medical, life-saving, or life-sustaining applications. Customers using or selling these products for use in such applications do so at their own risk and agree to fully indemnify Vishay for any damages resulting from such improper use or sale.