

P-Channel CICLON NexFET™ Power MOSFETs CSD23201W10



Features

- Ultra Low Qg & Qgd
- Small Footprint
- Low Profile 0.65mm height
- Pb Free
- Gate ESD Protection – 3kV
- RoHS Compliant
- Halogen Free



CSP 1.0 x 1.0 mm Wafer
Level Package

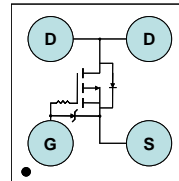

Top

Product Summary

V_{DS}	-12	V
Q_g	1.8	nC
Q_{gd}	0.4	nC
$R_{DS(on)}$	$V_{GS} = -1.5V$	110 mΩ
	$V_{GS} = -2.5V$	77 mΩ
	$V_{GS} = -4.5V$	66 mΩ
V_{th}	-0.6	V

Maximum Values ($T_A = 25^\circ C$ unless otherwise stated)

Symbol	Parameter	Value	Units
V_{DS}	Drain to Source Voltage	-12	V
V_{GS}	Gate to Source Voltage	-5	V
I_D	Continuous Drain Current, $T_A = 25^\circ C^1$	-1.1	A
I_{DM}	Pulsed Drain Current, $T_A = 25^\circ C^{1,2}$	-4.4	A
P_D	Power Dissipation ¹	1.0	W
T_J, T_{STG}	Operating Junction and Storage Temperature Range	-55 to 150	$^\circ C$

1. $R_{thJA} = 100^\circ C/W$ on 1 in² Cu (2 oz.) on 0.060" thick FR4 PCB
2. Pulse width $\leq 300 \mu s$, duty cycle $\leq 2\%$

$R_{DS(ON)}$ vs. V_{GS}

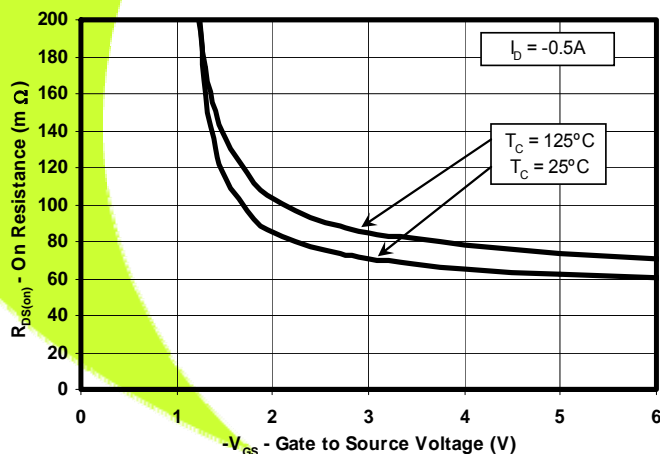

Gate Charge

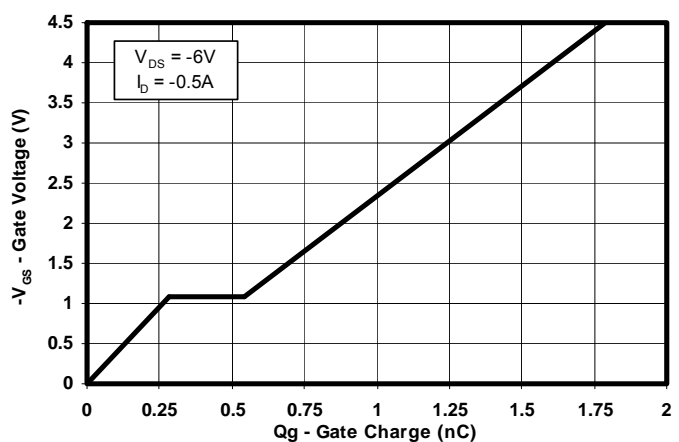

Ordering Information

Type	Package	Package Media	Qty	Ship
CSD23201W10	1.0 X 1.0 Wafer Level Package	7 inch reel	3000	Tape and Reel

P-Channel
CICLON NexFET™ Power MOSFETs
CSD23201W10



Electrical Characteristics ($T_A = 25^\circ\text{C}$ unless otherwise stated)

Symbol	Parameter	Test Conditions	Min	Typ	Max	Units
Static Characteristics						
BV_{DSS}	Drain to Source Voltage	$V_{GS} = 0V, I_D = -250\mu A$	-12	—	—	V
I_{DSS}	Drain to Source Leakage Current	$V_{GS} = 0V, V_{DS} = -9.6V$	—	—	-1	μA
I_{GSS}	Gate to Source Leakage Current	$V_{DS} = 0V, V_{GS} = -5V$	—	—	-100	nA
$V_{GS(th)}$	Gate to Source Threshold Voltage	$V_{DS} = V_{GS}, I_D = -250\mu A$	-0.4	-0.6	-1.0	V
$R_{DS(on)}$	Drain to Source On Resistance	$V_{GS} = -1.5V, I_D = -0.5A$	—	110	138	m Ω
		$V_{GS} = -2.5V, I_D = -0.5A$	—	77	96	m Ω
		$V_{GS} = -4.5V, I_D = -0.5A$	—	66	82	m Ω
g_{fs}	Transconductance	$V_{DS} = -6.0V, I_D = -0.5A$	—	9.0	—	S
Dynamic Characteristics						
C_{ISS}	Input Capacitance	$V_{GS} = 0V, V_{DS} = -6.0V$ $f = 1MHz$	—	250	325	pF
C_{OSS}	Output Capacitance		—	125	155	pF
C_{RSS}	Reverse Transfer Capacitance		—	32	42	pF
Q_g	Gate Charge Total (-4.5V)	$V_{DS} = -6.0V, I_D = -0.5A$	—	1.8	2.4	nC
Q_{gd}	Gate Charge Gate to Drain		—	0.26	—	nC
Q_{gs}	Gate Charge Gate to Source		—	0.28	—	nC
$Q_{g(th)}$	Gate Charge at V_{th}		—	0.11	—	nC
Q_{OSS}	Output Charge	$V_{DS} = -6.0V, V_{GS} = 0V$	—	1.7	—	nC
$t_{d(on)}$	Turn On Delay Time	$V_{DS} = -6.0V$ $V_{GS} = -2.5V, I_D = -0.5A$ $R_G = 20\Omega$	—	24	—	ns
t_r	Rise Time		—	19	—	ns
$t_{d(off)}$	Turn Off Delay Time		—	68	—	ns
t_f	Fall Time		—	29	—	ns
Diode Characteristics						
V_{SD}	Diode Forward Voltage	$I_S = -0.5A, V_{GS} = 0V$	—	-0.77	-1.0	V
Q_{rr}	Reverse Recovery Charge	$V_{dd} = -4.0V, I_F = -0.5A,$ $di/dt = 100A/\mu s$	—	2.0	—	nC
t_{rr}	Reverse Recovery Time	$V_{dd} = -4.0V, I_F = -0.5A,$ $di/dt = 100A/\mu s$	—	9.5	—	ns

P-Channel CICLON NexFET™ Power MOSFETs CSD23201W10



Thermal Characteristics ($T_A = 25^\circ\text{C}$ unless otherwise stated)

Symbol	Parameter	Min	Typ	Max	Units
Thermal Characteristics					
$R_{\theta JA}$	Thermal Resistance Junction to Ambient (Minimum Cu area)	—	—	245	$^\circ\text{C/W}$
$R_{\theta JA}$	Thermal Resistance Junction to Ambient (1 in ² Cu area)	—	—	125	$^\circ\text{C/W}$

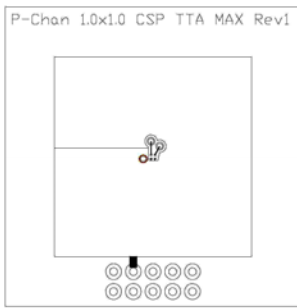

Max $R_{\theta JA} = 125^\circ\text{C/W}$
when mounted on 1in² of
2 oz. Cu.

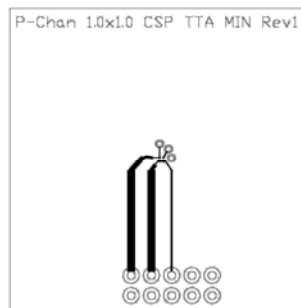

Max $R_{\theta JA} = 245^\circ\text{C/W}$ when
mounted on min pad area of
2 oz. Cu.

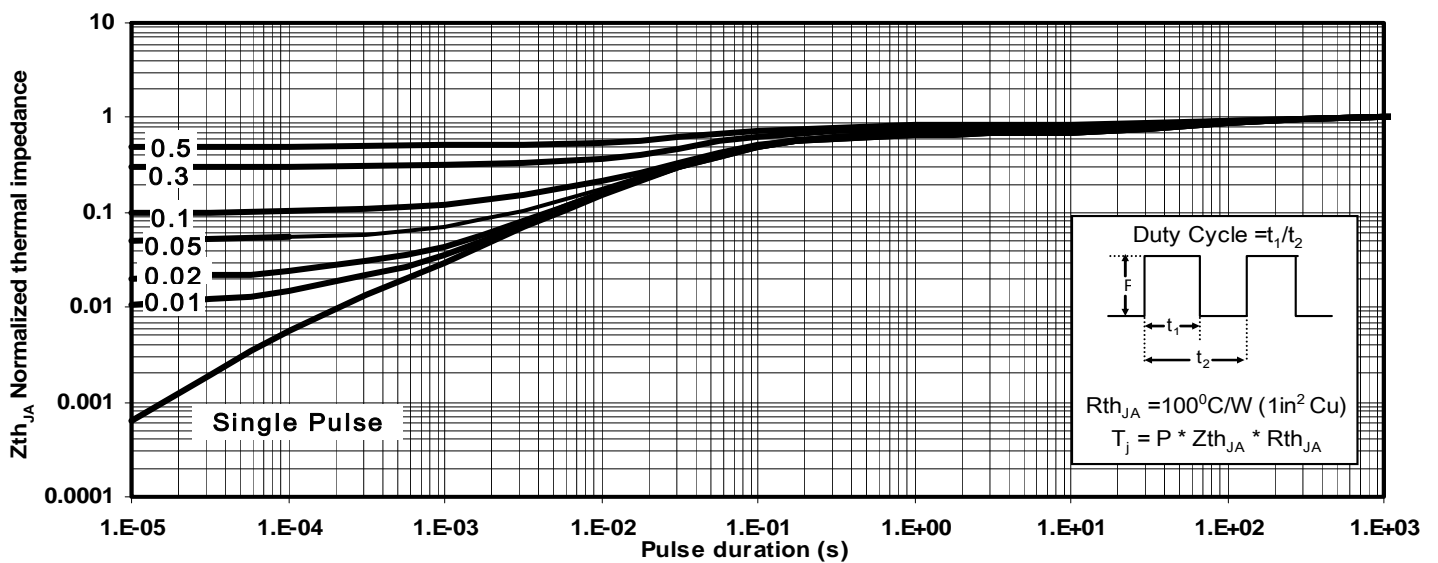

Figure 1: Transient Thermal Impedance

P-Channel
CICLON NexFET™ Power MOSFETs
CSD23201W10



Typical MOSFET Characteristics ($T_A = 25^\circ\text{C}$ unless otherwise stated)

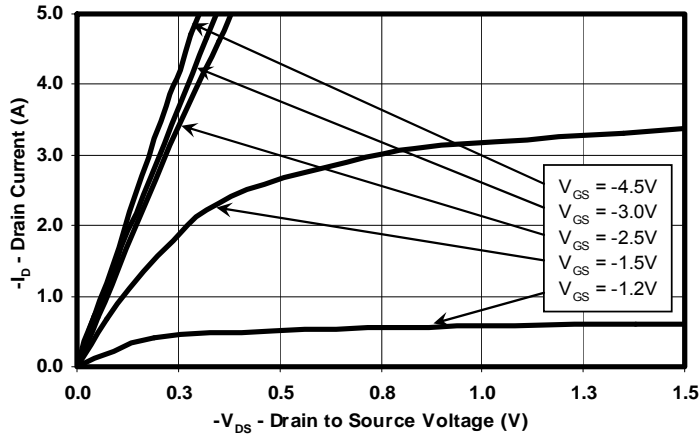

Figure 2: Saturation Characteristics

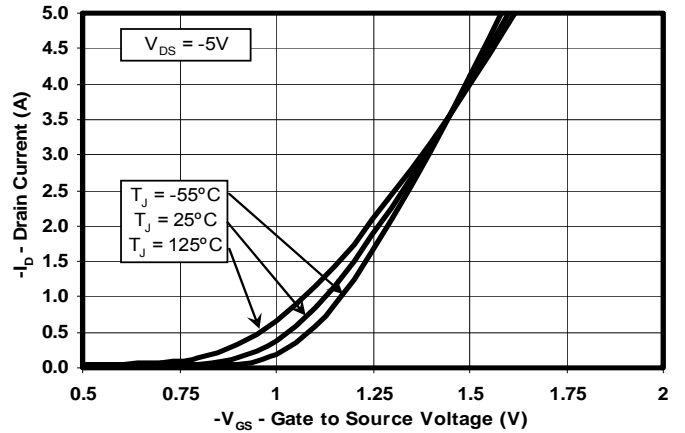

Figure 3: Transfer Characteristics

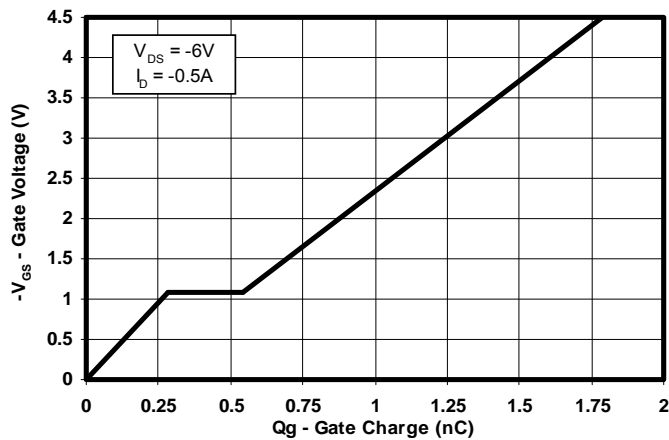

Figure 4: Gate Charge

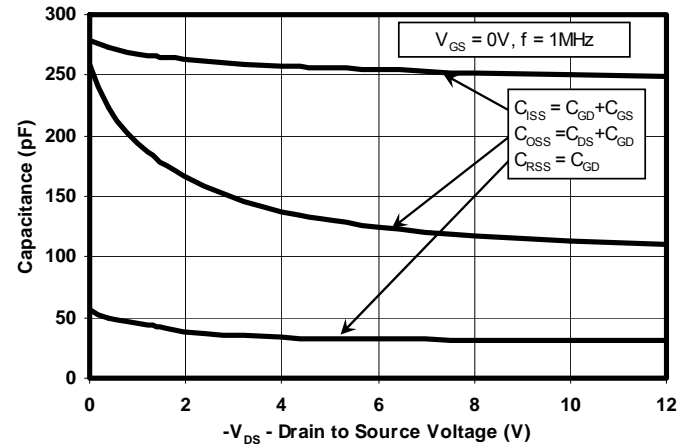

Figure 5: Capacitance

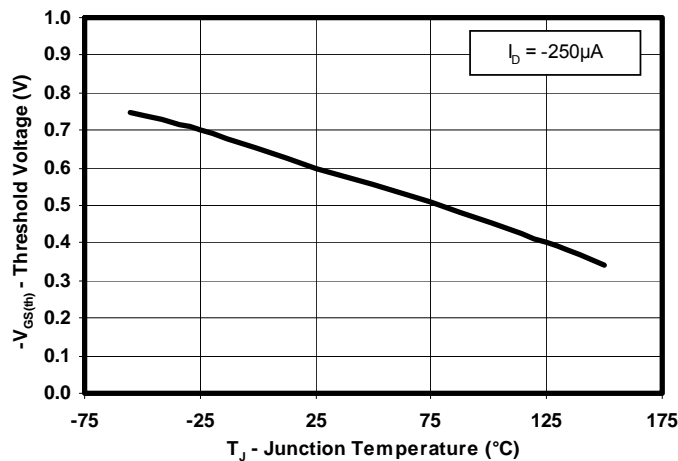

Figure 6: Threshold Voltage vs. Temperature

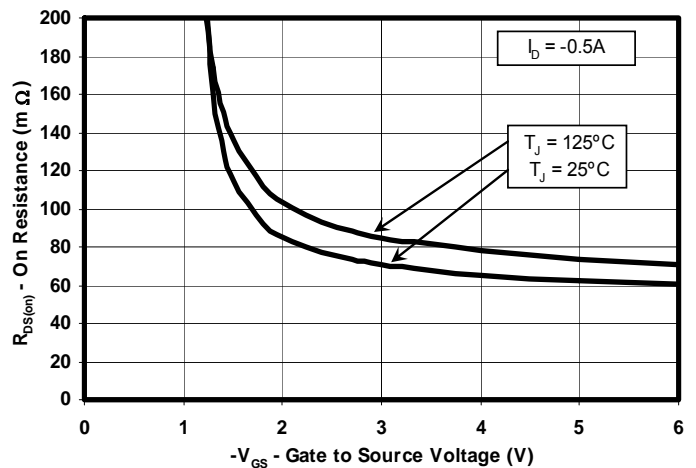

Figure 7: On Resistance vs. Gate Voltage

P-Channel CICLON NexFET™ Power MOSFETs CSD23201W10



Typical MOSFET Characteristics ($T_A = 25^\circ\text{C}$ unless otherwise stated)

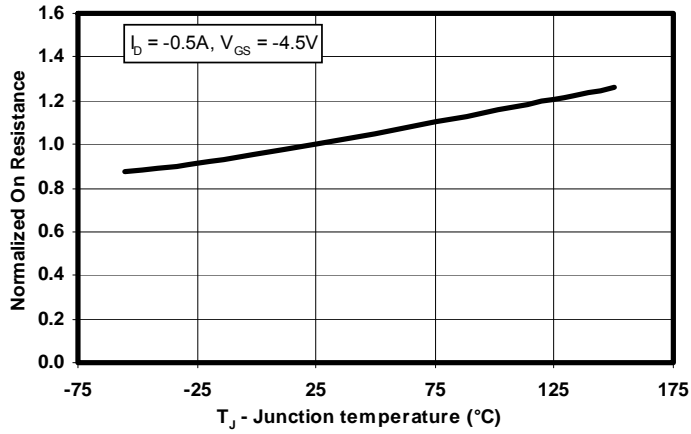

Figure 8: On Resistance vs. Temperature

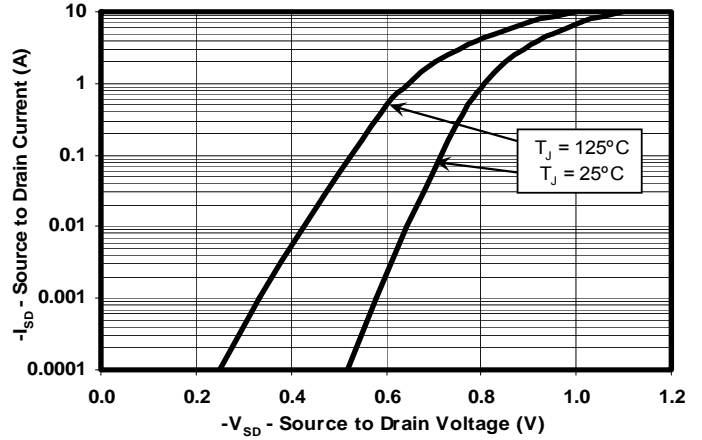

Figure 9: Typical Diode Forward Voltage

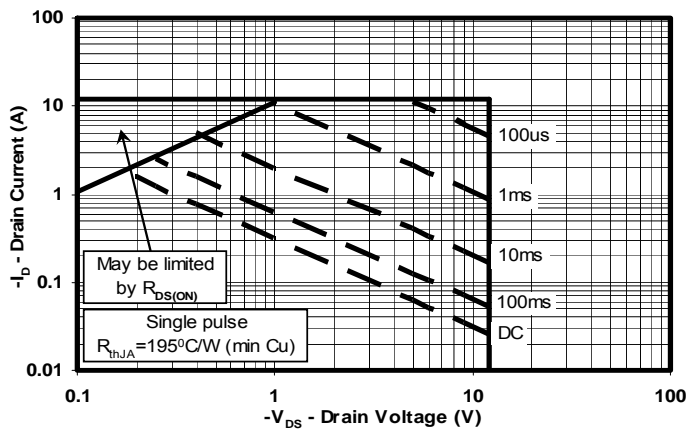

Figure 10: Maximum Safe Operating Area

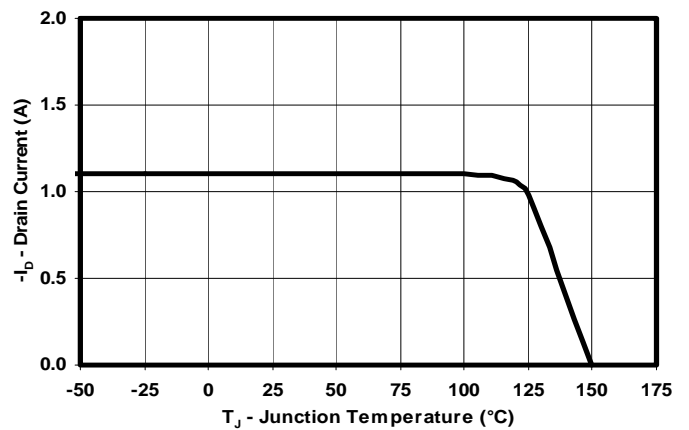
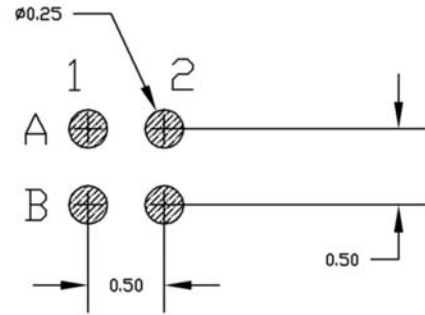
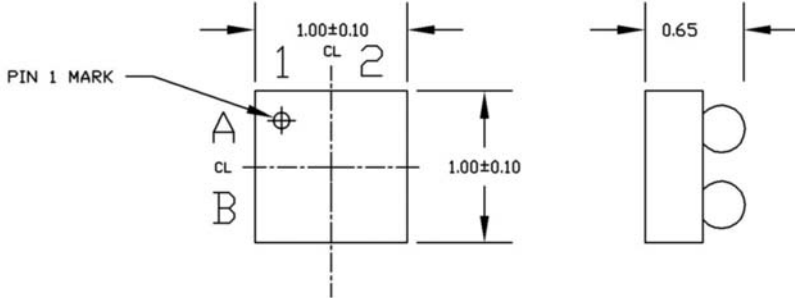

Figure 11: Maximum Drain Current vs. Temperature

P-Channel
CICLON NexFET™ Power MOSFETs
CSD23201W10



CSD23201W10 Package Dimensions



LAND PATTERN RECOMMENDATION

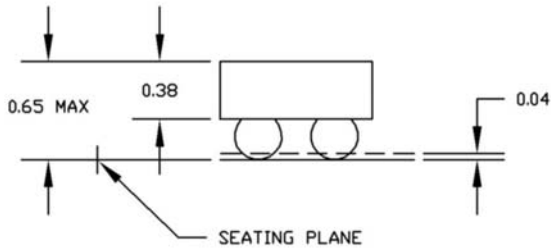

SOLDER BALL

NOTES: UNLESS OTHERWISE SPECIFIED

- A) ALL DIMENSIONS ARE IN MILLIMETERS
- B) TERMINAL CONFIGURATION TABLE.

POSITION	DESIGNATION
A2, B2	DRAIN
A1	GATE
B1	SOURCE

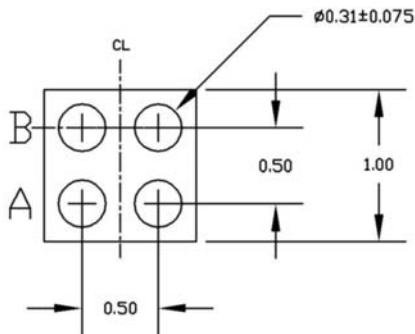

P-Channel
CICLON NexFET™ Power MOSFETs
CSD23201W10



Tape and Reel Information

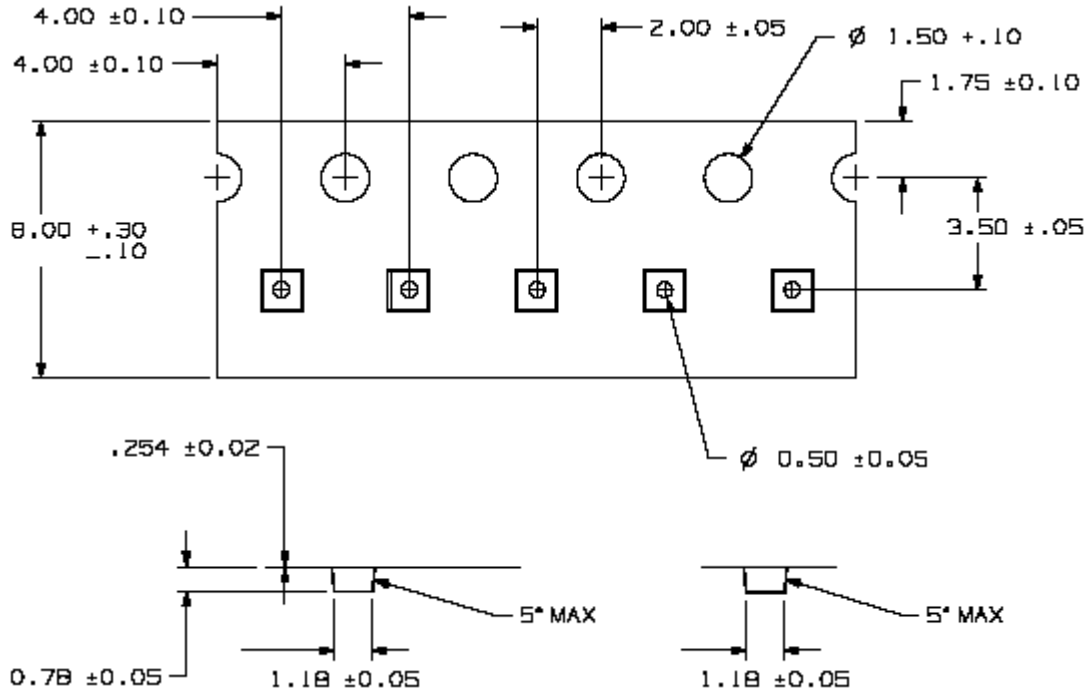

Package Marking Information

Location:

1st Line

Product Code = 321 (Fixed Text)

2nd Line

XXX = Last 3 digits of wafer lot number

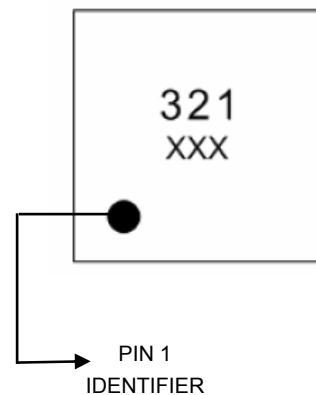

P-Channel
CICLON NexFET™ Power MOSFETs
CSD23201W10



Disclaimer

CICLON Semiconductor Device Corp. ("**CICLON**") reserves the right to make corrections, modifications, enhancements, improvements and other changes to its products and services at any time and to discontinue any product or service without notice. Customers should obtain the latest relevant information before placing orders and should verify that such information is current and complete. All products are sold subject to **CICLON**'s terms and conditions of sale supplied at the time of order acknowledgement.

Additional Information

For further information on technology, delivery terms and conditions, or pricing please contact your nearest **CICLON** Semiconductor representative.

CICLON Semiconductor Device Corp.
116 Research Drive, Bethlehem, PA 18015
T 610-849-5100 F 610-849-5101

© 2008 **CICLON** Semiconductor Device Corp., rev 2.1
All rights reserved.

www.ciclonsemi.com

PACKAGING INFORMATION

Orderable Device	Status ⁽¹⁾	Package Type	Package Drawing	Pins	Package Qty	Eco Plan ⁽²⁾	Lead/Ball Finish	MSL Peak Temp ⁽³⁾
CSD23201W10	ACTIVE	DSBGA	YZB	4	3000	Green (RoHS & no Sb/Br)	SNAGCU	Level-1-260C-UNLIM

⁽¹⁾ The marketing status values are defined as follows:

ACTIVE: Product device recommended for new designs.

LIFEBUY: TI has announced that the device will be discontinued, and a lifetime-buy period is in effect.

NRND: Not recommended for new designs. Device is in production to support existing customers, but TI does not recommend using this part in a new design.

PREVIEW: Device has been announced but is not in production. Samples may or may not be available.

OBSOLETE: TI has discontinued the production of the device.

⁽²⁾ Eco Plan - The planned eco-friendly classification: Pb-Free (RoHS), Pb-Free (RoHS Exempt), or Green (RoHS & no Sb/Br) - please check <http://www.ti.com/productcontent> for the latest availability information and additional product content details.

TBD: The Pb-Free/Green conversion plan has not been defined.

Pb-Free (RoHS): TI's terms "Lead-Free" or "Pb-Free" mean semiconductor products that are compatible with the current RoHS requirements for all 6 substances, including the requirement that lead not exceed 0.1% by weight in homogeneous materials. Where designed to be soldered at high temperatures, TI Pb-Free products are suitable for use in specified lead-free processes.

Pb-Free (RoHS Exempt): This component has a RoHS exemption for either 1) lead-based flip-chip solder bumps used between the die and package, or 2) lead-based die adhesive used between the die and leadframe. The component is otherwise considered Pb-Free (RoHS compatible) as defined above.

Green (RoHS & no Sb/Br): TI defines "Green" to mean Pb-Free (RoHS compatible), and free of Bromine (Br) and Antimony (Sb) based flame retardants (Br or Sb do not exceed 0.1% by weight in homogeneous material)

⁽³⁾ MSL, Peak Temp. -- The Moisture Sensitivity Level rating according to the JEDEC industry standard classifications, and peak solder temperature.

Important Information and Disclaimer: The information provided on this page represents TI's knowledge and belief as of the date that it is provided. TI bases its knowledge and belief on information provided by third parties, and makes no representation or warranty as to the accuracy of such information. Efforts are underway to better integrate information from third parties. TI has taken and continues to take reasonable steps to provide representative and accurate information but may not have conducted destructive testing or chemical analysis on incoming materials and chemicals. TI and TI suppliers consider certain information to be proprietary, and thus CAS numbers and other limited information may not be available for release.

In no event shall TI's liability arising out of such information exceed the total purchase price of the TI part(s) at issue in this document sold by TI to Customer on an annual basis.

IMPORTANT NOTICE

Texas Instruments Incorporated and its subsidiaries (TI) reserve the right to make corrections, modifications, enhancements, improvements, and other changes to its products and services at any time and to discontinue any product or service without notice. Customers should obtain the latest relevant information before placing orders and should verify that such information is current and complete. All products are sold subject to TI's terms and conditions of sale supplied at the time of order acknowledgment.

TI warrants performance of its hardware products to the specifications applicable at the time of sale in accordance with TI's standard warranty. Testing and other quality control techniques are used to the extent TI deems necessary to support this warranty. Except where mandated by government requirements, testing of all parameters of each product is not necessarily performed.

TI assumes no liability for applications assistance or customer product design. Customers are responsible for their products and applications using TI components. To minimize the risks associated with customer products and applications, customers should provide adequate design and operating safeguards.

TI does not warrant or represent that any license, either express or implied, is granted under any TI patent right, copyright, mask work right, or other TI intellectual property right relating to any combination, machine, or process in which TI products or services are used. Information published by TI regarding third-party products or services does not constitute a license from TI to use such products or services or a warranty or endorsement thereof. Use of such information may require a license from a third party under the patents or other intellectual property of the third party, or a license from TI under the patents or other intellectual property of TI.

Reproduction of TI information in TI data books or data sheets is permissible only if reproduction is without alteration and is accompanied by all associated warranties, conditions, limitations, and notices. Reproduction of this information with alteration is an unfair and deceptive business practice. TI is not responsible or liable for such altered documentation. Information of third parties may be subject to additional restrictions.

Resale of TI products or services with statements different from or beyond the parameters stated by TI for that product or service voids all express and any implied warranties for the associated TI product or service and is an unfair and deceptive business practice. TI is not responsible or liable for any such statements.

TI products are not authorized for use in safety-critical applications (such as life support) where a failure of the TI product would reasonably be expected to cause severe personal injury or death, unless officers of the parties have executed an agreement specifically governing such use. Buyers represent that they have all necessary expertise in the safety and regulatory ramifications of their applications, and acknowledge and agree that they are solely responsible for all legal, regulatory and safety-related requirements concerning their products and any use of TI products in such safety-critical applications, notwithstanding any applications-related information or support that may be provided by TI. Further, Buyers must fully indemnify TI and its representatives against any damages arising out of the use of TI products in such safety-critical applications.

TI products are neither designed nor intended for use in military/aerospace applications or environments unless the TI products are specifically designated by TI as military-grade or "enhanced plastic." Only products designated by TI as military-grade meet military specifications. Buyers acknowledge and agree that any such use of TI products which TI has not designated as military-grade is solely at the Buyer's risk, and that they are solely responsible for compliance with all legal and regulatory requirements in connection with such use.

TI products are neither designed nor intended for use in automotive applications or environments unless the specific TI products are designated by TI as compliant with ISO/TS 16949 requirements. Buyers acknowledge and agree that, if they use any non-designated products in automotive applications, TI will not be responsible for any failure to meet such requirements.

Following are URLs where you can obtain information on other Texas Instruments products and application solutions:

Products

Amplifiers	amplifier.ti.com
Data Converters	dataconverter.ti.com
DLP® Products	www.dlp.com
DSP	dsp.ti.com
Clocks and Timers	www.ti.com/clocks
Interface	interface.ti.com
Logic	logic.ti.com
Power Mgmt	power.ti.com
Microcontrollers	microcontroller.ti.com
RFID	www.ti-rfid.com
RF/IF and ZigBee® Solutions	www.ti.com/lprf

Applications

Audio	www.ti.com/audio
Automotive	www.ti.com/automotive
Broadband	www.ti.com/broadband
Digital Control	www.ti.com/digitalcontrol
Medical	www.ti.com/medical
Military	www.ti.com/military
Optical Networking	www.ti.com/opticalnetwork
Security	www.ti.com/security
Telephony	www.ti.com/telephony
Video & Imaging	www.ti.com/video
Wireless	www.ti.com/wireless

Mailing Address: Texas Instruments, Post Office Box 655303, Dallas, Texas 75265
Copyright © 2009, Texas Instruments Incorporated