

8-Channel, 12-Bit, 70MSPS Analog-to-Digital Converter with Serial LVDS Interface

FEATURES

- **Maximum Sample Rate: 70MSPS**
- **12-Bit Resolution**
- **No Missing Codes**
- **Total Power Dissipation:**
Internal Reference: 1W
External Reference: 937mW
- **CMOS Technology**
- **Simultaneous Sample-and-Hold**
- **71dBFS SNR at 5MHz IF**
- **3.3V Digital/Analog Supply**
- **Serialized LVDS Outputs**
- **Integrated Frame and Bit Patterns**
- **Option to Double LVDS Clock Output Currents**
- **Four Current Modes for LVDS**
- **Pin- and Format-Compatible Family**
- **TQFP-80 PowerPAD™ Package**

APPLICATIONS

- **Portable Ultrasound Systems**
- **Test Equipment**
- **Military**

DESCRIPTION

The ADS5273 is a high-performance, CMOS, 70MSPS, 8-channel analog-to-digital converter (ADC). An internal reference is provided, simplifying system design requirements. Low power consumption allows for the highest of system integration densities. Serial LVDS (low-voltage differential signaling) outputs reduce the number of interface lines and package size.

RELATED PRODUCTS

MODEL	RESOLUTION (BITS)	SAMPLE RATE (MSPS)	CHANNELS
ADS5270	12	40	8
ADS5271	12	50	8
ADS5272	12	65	8
ADS5277	10	65	8

An integrated phase lock loop (PLL) multiplies the incoming ADC sampling clock by a factor of 12. This high-frequency LVDS clock is used in the data serialization and transmission process. The word output of each internal ADC is serialized and transmitted either MSB or LSB first. In addition to the eight data outputs, a bit clock and a word clock are also transmitted. The bit clock is at 6x the speed of the sampling clock, whereas the word clock is at the same speed of the sampling clock.

The ADS5273 provides an internal reference, or can optionally be driven with an external reference. Best performance is achieved through the internal reference mode.

The device is available in a PowerPAD TQFP-80 package and is specified over a -40°C to $+85^{\circ}\text{C}$ operating range.

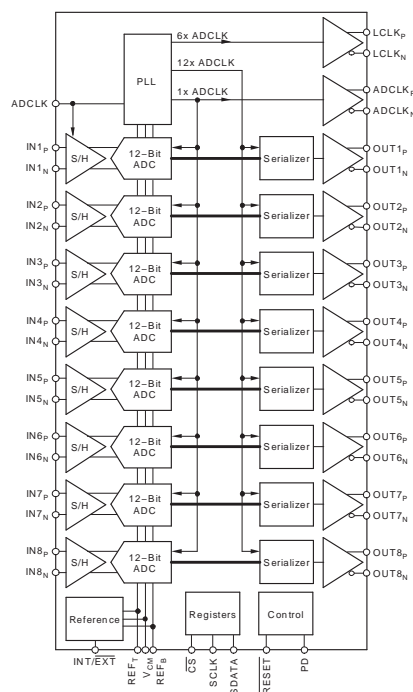

Please be aware that an important notice concerning availability, standard warranty, and use in critical applications of Texas Instruments semiconductor products and disclaimers thereto appears at the end of this data sheet.

PowerPAD is a trademark of Texas Instruments.
All other trademarks are the property of their respective owners.



This integrated circuit can be damaged by ESD. Texas Instruments recommends that all integrated circuits be handled with appropriate precautions. Failure to observe proper handling and installation procedures can cause damage.

ESD damage can range from subtle performance degradation to complete device failure. Precision integrated circuits may be more susceptible to damage because very small parametric changes could cause the device not to meet its published specifications.

ORDERING INFORMATION⁽¹⁾

PRODUCT	PACKAGE-LEAD ⁽²⁾	PACKAGE DESIGNATOR	SPECIFIED TEMPERATURE RANGE	PACKAGE MARKING	ORDERING NUMBER	TRANSPORT MEDIA, QUANTITY
ADS5273	HTQFP-80	PFP	–40°C to +85°C	ADS5273IPFP	ADS5273IPFP	Tray, 96
					ADS5273IPFPT	Tape and Reel, 250

- (1) For the most current package and ordering information, see the Package Option Addendum at the end of this document or see the TI web site at www.ti.com.
- (2) Thermal pad size: 4.69mm x 4.69mm (min), 6.20mm x 6.20mm (max).

ABSOLUTE MAXIMUM RATINGS⁽¹⁾

Analog Supply Voltage Range, AVDD	–0.3V to +3.8V
Output Driver Supply Voltage Range, LVDD	–0.3V to +3.8V
Voltage Between AVSS and LVSS	–0.3V to +0.3V
Voltage Between AVDD and LVDD	–0.3V to +0.3V
Voltages Applied to External REF Pins	–0.3V to +2.4V
All LVDS Data and Clock Outputs	–0.3V to +2.4V
Analog Input Pins ⁽²⁾	–0.3V to min. [3.3V, (AVDD + 0.3V)]
Digital Input Pins, Set 1 (pins 69, 76-78)	–0.3V to min. [3.9V, (AVDD + 0.3V)] ⁽³⁾
Digital Input Pins, Set 2 (pins 16, 45)	–0.3V to min. [3.9V, (LVDD + 0.3V)] ⁽³⁾
Operating Free-Air Temperature Range, T _A	–40°C to +85°C
Lead Temperature, 1.6mm (1/16" from case for 10s)	+260°C
Junction Temperature	+105°C
Storage Temperature Range	–65°C to +150°C

- (1) Stresses above these ratings may cause permanent damage. Exposure to absolute maximum conditions for extended periods may degrade device reliability. These are stress ratings only, and functional operation of the device at these or any other conditions beyond those specified is not supported.
- (2) The dc voltage applied on the input pins should not go below –0.3V. Also, the dc voltage should be limited to the lower of either 3.3V or (AVDD + 0.3V). If the input can go higher than +3.3V, then a resistor greater than or equal to 25Ω should be added in series with each of the input pins. Also, the duty cycle of the overshoot beyond +3.3V should be limited. The overshoot duty cycle can be defined either as a percentage of the time of overshoot over a clock period, or over the entire device lifetime. For a peak voltage between +3.3V and +3.5V, a duty cycle up to 10% is acceptable. For a peak voltage between +3.5V and +3.7V, the overshoot duty cycle should not exceed 1%. Any overshoot beyond +3.7V should be restricted to less than 0.1% duty cycle, and never exceed +3.9V.
- (3) It is recommended that a series resistor of 1kΩ or greater be used if the digital input pins are tied to AVDD or LVDD.

RECOMMENDED OPERATING CONDITIONS

PARAMETER	ADS5273			UNITS
	MIN	TYP	MAX	
SUPPLIES AND REFERENCES				
Analog Supply Voltage, AVDD	3.0	3.3	3.6	V
Output Driver Supply Voltage, LVDD	3.0	3.3	3.6	V
REF _T — External Reference Mode	1.825	1.95	2.0	V
REF _B — External Reference Mode	0.9	0.95	1.075	V
REF _{CM} = (REF _T + REF _B)/2 – External Reference Mode ⁽¹⁾	1.4	V _{CM} ± 50mV	1.5	V
Reference = (REF _T – REF _B) – External Reference Mode	0.75	1.0	1.1	V
Analog Input Common-Mode Range ⁽²⁾		V _{CM} ± 50mV		V
CLOCK INPUT AND OUTPUTS				
ADCLK Input Sample Rate (low-voltage TTL)	20		70	MSPS
ADCLK Duty Cycle	45		55	%
Low-Level Voltage Clock Input			0.6	V
High-Level Voltage Clock Input	2.2			V
ADCLK _P and ADCLK _N Outputs (LVDS)	20		70	MHz
LCLK _P and LCLK _N Outputs (LVDS) ⁽²⁾	120		420	MHz
Operating Free-Air Temperature, T _A	–40		+85	°C
Thermal Characteristics:				
θ _{JA}		19.4		°C/W
θ _{JC}		4.2		°C/W

(1) These voltages need to be set to 1.45V ± 50mV if they are derived independent of V_{CM}.

(2) 6 × ADCLK.

ELECTRICAL CHARACTERISTICS

$T_{MIN} = -40^{\circ}\text{C}$ and $T_{MAX} = +85^{\circ}\text{C}$. Typical values are at $T_A = +25^{\circ}\text{C}$, clock frequency = 70MSPS, 50% clock duty cycle, AVDD = 3.3V, LVDD = 3.3V, -1dBFS , $I_{SET} = 56.2\text{k}\Omega$, internal voltage reference, and LVDS buffer current at 3.5mA per channel, unless otherwise noted. All values are applicable after the device has been reset.

PARAMETER	TEST CONDITIONS	ADS5273			UNITS
		MIN	TYP	MAX	
DC ACCURACY					
No Missing Codes			Tested		
DNL Differential Nonlinearity	$f_{IN} = 5\text{MHz}$	-0.99	± 0.34	+1.2	LSB
INL Integral Nonlinearity	$f_{IN} = 5\text{MHz}$	-3.0	± 0.43	+3.0	LSB
Offset Error ⁽¹⁾		-0.75		+0.75	%FS
Offset Temperature Coefficient			± 6		ppm/ $^{\circ}\text{C}$
Fixed Attenuation in Channel ⁽²⁾			1.5		%FS
Fixed Attenuation Matching Across Channels			0.01	0.2	dB
Gain Error/Reference Error ⁽³⁾	$V_{REF_T} - V_{REF_B}$	-2.5	± 1.0	+2.5	%FS
Gain Error Temperature Coefficient			± 20		ppm/ $^{\circ}\text{C}$
POWER REQUIREMENTS⁽⁴⁾					
Internal Reference					
Power Dissipation	Analog Only (AVDD)		800	868	mW
	Output Driver (LVDD)		203	231	mW
Total Power Dissipation			1003	1099	mW
External Reference					
Power Dissipation	Analog Only (AVDD)		734		mW
	Output Driver (LVDD)		203		mW
Total Power Dissipation			937		mW
Total Power-Down	Clock Running		95	149	mW
REFERENCE VOLTAGES					
V_{REF_T} Reference Top (internal)		1.9	1.95	2.0	V
V_{REF_B} Reference Bottom (internal)		0.9	0.95	1.0	V
V_{CM} Common-Mode Voltage		1.4	1.45	1.5	V
V_{CM} Output Current ⁽⁵⁾	$\pm 50\text{mV}$ Change in Voltage		± 2.0		mA
V_{REF_T} Reference Top (external)		1.825	1.95	2.0	V
V_{REF_B} Reference Bottom (external)		0.9	0.95	1.075	V
External Reference Common-Mode			$V_{CM} \pm 50\text{mV}$		V
External Reference Input Current ⁽⁶⁾			1.0		mA

- (1) Offset error is the deviation of the average code from mid-code with -1dBFS sinusoid from ideal mid-code (2048). Offset error is expressed in terms of % of full-scale.
- (2) Fixed attenuation in the channel arises due to a fixed attenuation of about 1% in the sample-and-hold amplifier. When the differential voltage at the analog input pins are changed from $-V_{REF}$ to $+V_{REF}$, the swing of the output code is expected to deviate from the full-scale code (4096LSB) by the extent of this fixed attenuation. NOTE: V_{REF} is defined as $(V_{REF_T} - V_{REF_B})$.
- (3) The reference voltages are trimmed at production so that $(V_{REF_T} - V_{REF_B})$ is within $\pm 25\text{mV}$ of the ideal value of 1V. It does not include fixed attenuation.
- (4) Supply current can be calculated from dividing the power dissipation by the supply voltage of 3.3V.
- (5) V_{CM} provides the common-mode current for the inputs of all eight channels when the inputs are ac-coupled. The V_{CM} output current specified is the additional drive of the V_{CM} buffer if loaded externally.
- (6) Average current drawn from the reference pins in the external reference mode.

ELECTRICAL CHARACTERISTICS (continued)

$T_{MIN} = -40^{\circ}\text{C}$ and $T_{MAX} = +85^{\circ}\text{C}$. Typical values are at $T_A = +25^{\circ}\text{C}$, clock frequency = 70MSPS, 50% clock duty cycle, $AVDD = 3.3\text{V}$, $LVDD = 3.3\text{V}$, -1dBFS , $I_{SET} = 56.2\text{k}\Omega$, internal voltage reference, and LVDS buffer current at 3.5mA per channel, unless otherwise noted. All values are applicable after the device has been reset.

PARAMETER	TEST CONDITIONS	ADS5273			UNITS
		MIN	TYP	MAX	
ANALOG INPUT					
Differential Input Capacitance			4.0		pF
Analog Input Common-Mode Range			$V_{CM} \pm 50$		mV
Differential Full-Scale Input Voltage Range	Internal Reference		2.03		V_{PP}
	External Reference		$2.03 \times (V_{REF_T} - V_{REF_B})$		V_{PP}
Voltage Overload Recovery Time ⁽⁷⁾			3.0		CLK Cycles
Input Bandwidth	-3dBFS , 25Ω Series Resistances		300		MHz
DIGITAL DATA INPUTS					
V_{IH} High-Level Input Voltage		2.2			V
V_{IL} Low-Level Input Voltage				0.6	V
C_{IN} Input Capacitance			3.0		pF
DIGITAL DATA OUTPUTS					
Data Format			Straight Offset Binary		
Data Bit Rate		240		840	Mbps
SERIAL INTERFACE					
SCLK Serial Clock Input Frequency				20	MHz

(7) A differential ON/OFF pulse is applied to the ADC input. The differential amplitude of the pulse in its ON (high) state is twice the full-scale range of the ADC, while the differential amplitude of the pulse in its OFF (low) state is zero. The overload recovery time of the ADC is measured as the time required by the ADC output code to settle within 1% of full-scale, as measured from its mid-code value when the pulse is switched from ON (high) to OFF (low).

REFERENCE SELECTION

MODE	INT/EXT	DESCRIPTION
Internal Reference; $FSR = 2.03V_{PP}$	1	Default with internal pull-up.
External Reference; $FSR = 2.03 \times (REF_T - REF_B)$	0	Internal reference is powered down. The common-mode voltage of the external reference should be within 50mV of V_{CM} . V_{CM} is derived from the internal bandgap voltage.

AC CHARACTERISTICS

T_{MIN} = -40°C and T_{MAX} = +85°C. Typical values are at T_A = +25°C, sampling rate = 70MSPS, 50% clock duty cycle, AVDD = 3.3V, LVDD = 3.3V, -1dBFS, I_{SET} = 56.2kΩ, internal voltage reference, and LVDS buffer current at 3.5mA per channel, unless otherwise noted. All voltages are applicable after the device has been reset.

PARAMETER	CONDITIONS	ADS5273			UNITS
		MIN	TYP	MAX	
DYNAMIC CHARACTERISTICS					
SFDR Spurious-Free Dynamic Range	f _{IN} = 1MHz		92		dBc
	f _{IN} = 5MHz	76	90		dBc
	f _{IN} = 10MHz		87		dBc
	f _{IN} = 20MHz		86		dBc
HD ₂ 2nd-Order Harmonic Distortion	f _{IN} = 1MHz		101		dBc
	f _{IN} = 5MHz	82	95		dBc
	f _{IN} = 10MHz		92		dBc
	f _{IN} = 20MHz		86		dBc
HD ₃ 3rd-Order Harmonic Distortion	f _{IN} = 1MHz		92		dBc
	f _{IN} = 5MHz	76	90		dBc
	f _{IN} = 10MHz		87		dBc
	f _{IN} = 20MHz		86		dBc
SNR Signal-to-Noise Ratio	f _{IN} = 1MHz		71.1		dBFS
	f _{IN} = 5MHz	69	71		dBFS
	f _{IN} = 10MHz		70.8		dBFS
	f _{IN} = 20MHz		70		dBFS
SINAD Signal-to-Noise and Distortion	f _{IN} = 1MHz		71		dBFS
	f _{IN} = 5MHz	68.5	70.8		dBFS
	f _{IN} = 10MHz		70.6		dBFS
	f _{IN} = 20MHz		69.8		dBFS
ENOB Effective Number of Bits	f _{IN} = 5MHz	11.1	11.5		Bits
Crosstalk	5MHz Full-Scale Signal Applied to 7 Channels; Measurement Taken on the Channel with No Input Signal		-89		dBc
IMD3 Two-Tone, Third-Order Intermodulation Distortion	f ₁ = 9.5MHz at -7dBFS f ₂ = 10.2MHz at -7dBFS		97		dBFS

LVDS DIGITAL DATA AND CLOCK OUTPUTS

Test conditions at $I_O = 3.5\text{mA}$, $R_{LOAD} = 100\Omega$, $C_{LOAD} = 6\text{pF}$, and 50% duty cycle. I_O refers to the current setting for the LVDS buffer. R_{LOAD} is the differential load resistance between the differential LVDS pair. C_{LOAD} is the effective single-ended load capacitance between each of the LVDS pins and ground. C_{LOAD} includes the receiver input parasitics as well as the routing parasitics. Measurements are done with a 1-inch transmission line of 100Ω characteristic impedance between the device and the load. All LVDS specifications are characterized, but not parametrically tested at production. LCLKOUT refers to (LCLK_P – LCLK_N); ADCLKOUT refers to (ADCLK_P – ADCLK_N); DATA OUT refers to (OUT_P – OUT_N); and ADCLK refers to the input sampling clock.

PARAMETER	CONDITIONS	MIN	TYP	MAX	UNITS
DC SPECIFICATIONS⁽¹⁾					
V_{OH} Output Voltage High, OUT _P or OUT _N	$R_{LOAD} = 100\Omega \pm 1\%$; See LVDS Timing Diagram, Page 8	1265	1365	1465	mV
V_{OL} Output Voltage Low, OUT _P or OUT _N	$R_{LOAD} = 100\Omega \pm 1\%$	940	1040	1140	mV
$ V_{OD} $ Output Differential Voltage	$R_{LOAD} = 100\Omega \pm 1\%$	275	325	375	mV
V_{OS} Output Offset Voltage ⁽²⁾	$R_{LOAD} = 100\Omega \pm 1\%$; See LVDS Timing Diagram, Page 8	1.1	1.2	1.3	V
R_O Output Impedance, Differential	Normal Operation		13		k Ω
R_O Output Impedance, Differential	Power-Down		20		k Ω
C_O Output Capacitance ⁽³⁾			4		pF
$ \Delta V_{OD} $ Change in $ V_{OD} $ Between 0 and 1	$R_{LOAD} = 100\Omega \pm 1\%$			10	mV
ΔV_{OS} Change Between 0 and 1	$R_{LOAD} = 100\Omega \pm 1\%$			25	mV
ISOUT Output Short-Circuit Current	Drivers Shorted to Ground			40	mA
ISOUT _{NP} Output Current	Drivers Shorted Together			12	mA
DRIVER AC SPECIFICATIONS					
ADCLKOUT Clock Duty Cycle ⁽⁴⁾		45	50	55	%
LCLKOUT Duty Cycle ⁽⁴⁾		40	50	60	%
Data Setup Time ⁽⁵⁾⁽⁶⁾		0.35			ns
Data Hold Time ⁽⁶⁾⁽⁷⁾		0.20			ns
LVDS Outputs Rise/Fall Time ⁽⁸⁾	$I_O = 2.5\text{mA}$		400		ps
	$I_O = 3.5\text{mA}$	180	300	500	ps
	$I_O = 4.5\text{mA}$		230		ps
	$I_O = 6.0\text{mA}$		180		ps
LCLKOUT Rising Edge to ADCLKOUT Rising Edge ⁽⁹⁾		0.33	0.60	0.86	ns
ADCLKOUT Rising Edge to LCLKOUT Falling Edge ⁽⁹⁾		0.33	0.60	0.86	ns
ADCLKOUT Rising Edge to DATA OUT Transition ⁽⁹⁾		-0.3	0	+0.3	ns

- (1) The dc specifications refer to the condition where the LVDS outputs are not switching, but are permanently at a valid logic level 0 or 1.
- (2) V_{OS} refers to the common-mode of OUT_P and OUT_N.
- (3) Output capacitance inside the device, from either OUT_P or OUT_N to ground.
- (4) Measured between zero crossings.
- (5) DATA OUT (OUT_P – OUT_N) crossing zero to LCLKOUT (LCLK_P – LCLK_N) crossing zero.
- (6) Data setup and hold time accounts for data-dependent skews, channel-to-channel mismatches, and effects of clock jitter in the device.
- (7) LCLKOUT crossing zero to DATA OUT crossing zero.
- (8) Measured from -100mV to +100mV on the differential output for rise time, and +100mV to -100mV for fall time.
- (9) Measured between zero crossings.

SWITCHING CHARACTERISTICS

$T_{MIN} = -40^\circ\text{C}$ and $T_{MAX} = +85^\circ\text{C}$. Typical values are at $T_A = 25^\circ\text{C}$, clock frequency = maximum specified, 50% clock duty cycle, AVDD = 3.3V, LVDD = 3.3V, -1dBFS, $I_{SET} = 56.2\text{k}\Omega$, internal voltage reference, and LVDS buffer current at 3.5mA per channel, unless otherwise noted.

PARAMETER	MIN	TYP	MAX	UNITS
SWITCHING SPECIFICATIONS				
t_{SAMPLE}	14.3		50	ns
$t_D(A)$ Aperture Delay ⁽¹⁾	2	4	6.5	ns
Aperture Jitter (uncertainty)		1		ps rms
$t_D(\text{pipeline})$ Latency		6.5		Cycles
t_{PROP} Propagation Delay ⁽²⁾	3	4.8	6.5	ns

- (1) Rising edge of ADCLK to actual instant when data is sampled within the ADC.
- (2) Falling edge of ADCLK to zero-crossing of rising edge of ADCLKOUT.

LVDS TIMING DIAGRAM (PER ADC CHANNEL)

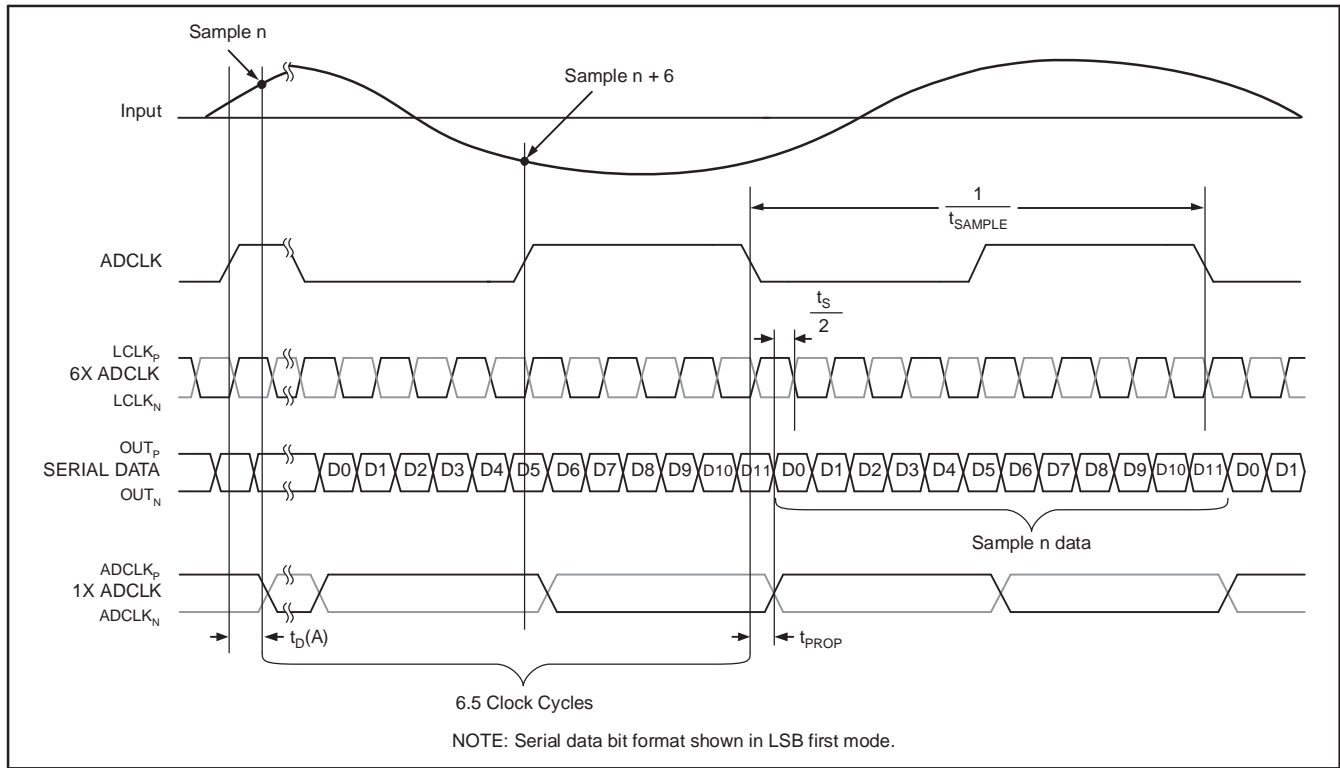

RECOMMENDED POWER-UP SEQUENCING AND RESET TIMING

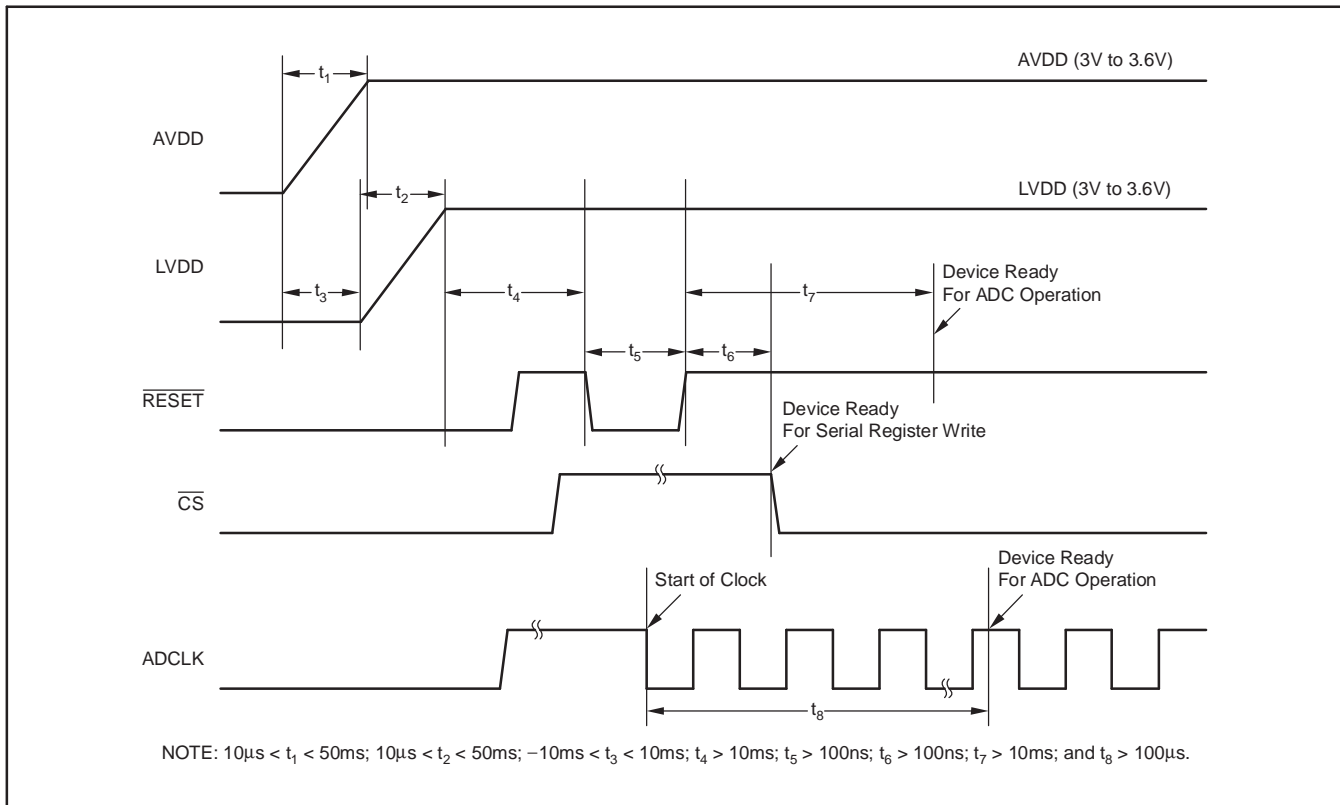

POWER-DOWN TIMING

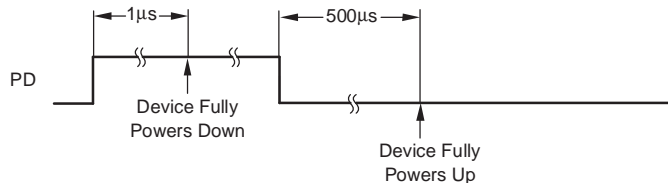

NOTE: The shown power-up time is based on 1µF bypass capacitors on the reference pins.
See the *Theory of Operation* section for details.

SERIAL INTERFACE TIMING

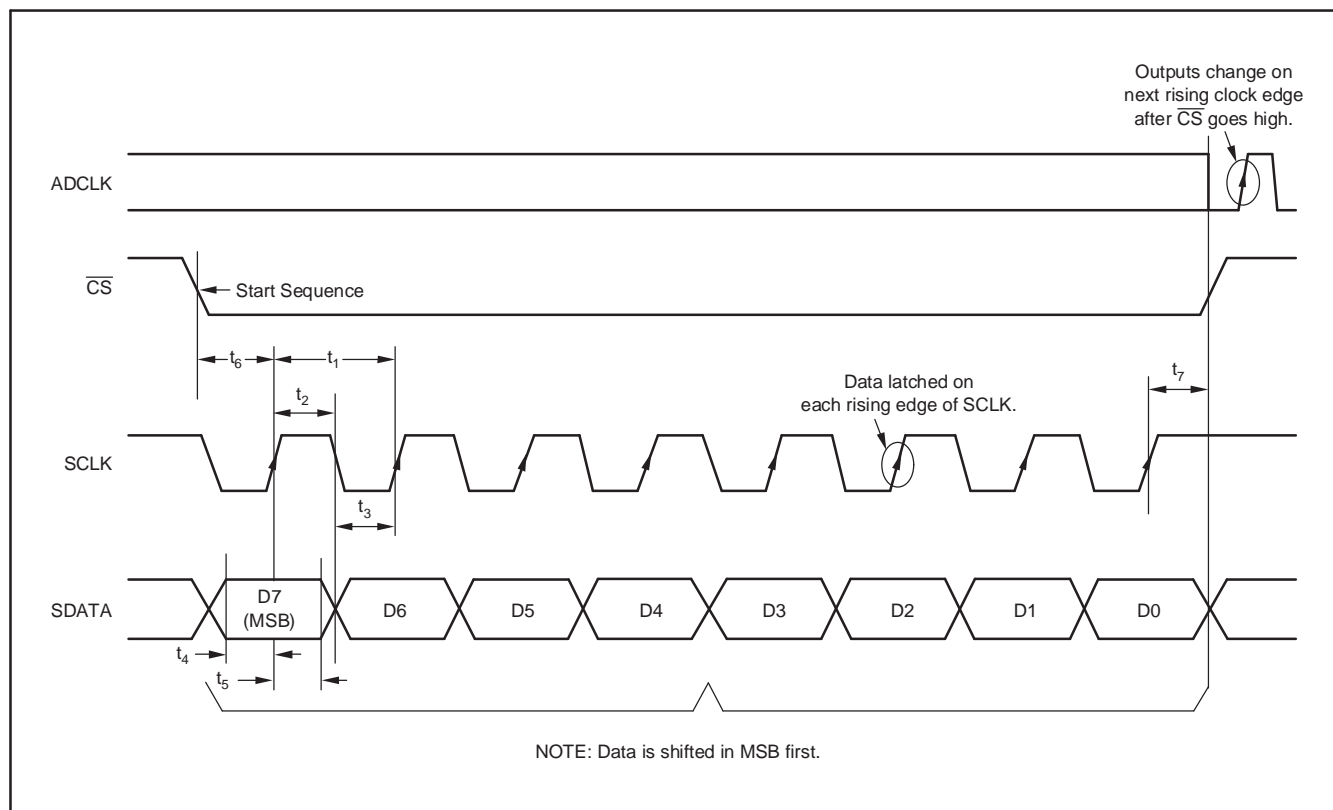

NOTE: Data is shifted in MSB first.

PARAMETER	DESCRIPTION	MIN	TYP	MAX	UNIT
t_1	Serial CLK Period	50			ns
t_2	Serial CLK High Time	20			ns
t_3	Serial CLK Low Time	20			ns
t_4	Data Setup Time	5			ns
t_5	Data Hold Time	5			ns
t_6	\overline{CS} Fall to SCLK Rise	8			ns
t_7	SCLK Rise to \overline{CS} Rise	8			ns

SERIAL INTERFACE REGISTERS

ADDRESS				DATA				DESCRIPTION	REMARKS
D7	D6	D5	D4	D3	D2	D1	D0		
0	0	0	0	0	0			LVDS BUFFERS (Register 0) Normal ADC Output	All Data Outputs (default after reset)
				0	1			Deskew Pattern	
				1	0			Sync Pattern	See <i>Test Patterns</i>
				1	1			Custom Pattern	
						0	0	Output Current in LVDS = 3.5mA	(default after reset)
						0	1	Output Current in LVDS = 2.5mA	
						1	0	Output Current in LVDS = 4.5mA	
						1	1	Output Current in LVDS = 6.0mA	
0	0	0	1	0	X	X	0	CLOCK CURRENT (Register 1) LVDS Clock Output Current	I _{OUT} = 3.5mA (default)
				0	X	X	1	2x LVDS Clock Output Current ⁽¹⁾	I _{OUT} = 7.0mA
				0	0	X	X	LSB/MSB MODE (Register 1) LSB Mode	(default after reset)
				0	1	X	X	MSB Mode	
0	0	1	0	X	X	X	X	POWER-DOWN ADC CHANNELS (Register 2) Power-Down Channels 1 to 4; D3 is for Channel 4 and D0 for Channel 1	Example: 1010 Powers Down Channels 4 and 2 and Keeps Channels 1 and 3 Active
0	0	1	1	X	X	X	X	POWER-DOWN ADC CHANNELS (Register 3) Power-Down Channels 5 to 8; D3 is for Channel 8 and D0 for Channel 5	
				D3	D2	D1	D0	CUSTOM PATTERN (Registers 4–6) Bits for Custom Pattern	See <i>Test Patterns</i>
0	1	0	0	X	X	X	X		
0	1	0	1	X	X	X	X		
0	1	1	0	X	X	X	X		

(1) Output current drive for the two clock LVDS buffers (LCLK_P and LCLK_N and ADCLK_P and ADCLK_N) is twice the output current setting programmed in register 0. The current drive of the data buffers remains the same as the setting in register 0.

TEST PATTERNS

Serial Output ⁽¹⁾	LSB											MSB
ADC Output ⁽²⁾	D0	D1	D2	D3	D4	D5	D6	D7	D8	D9	D10	D11
Deskew Pattern	1	0	1	0	1	0	1	0	1	0	1	0
Sync Pattern	0	0	0	0	0	0	1	1	1	1	1	1
Custom Pattern ⁽³⁾	D0(4)	D1(4)	D2(4)	D3(4)	D0(5)	D1(5)	D2(5)	D3(5)	D0(6)	D1(6)	D2(6)	D3(6)

(1) The serial output stream comes out LSB first by default.

(2) D11...D0 represent the 12 output bits from the ADC.

(3) D0(4) represents the content of the bit D0 of register 4, D3(6) represents the content of bit D3 of register 6, etc.

PIN CONFIGURATION

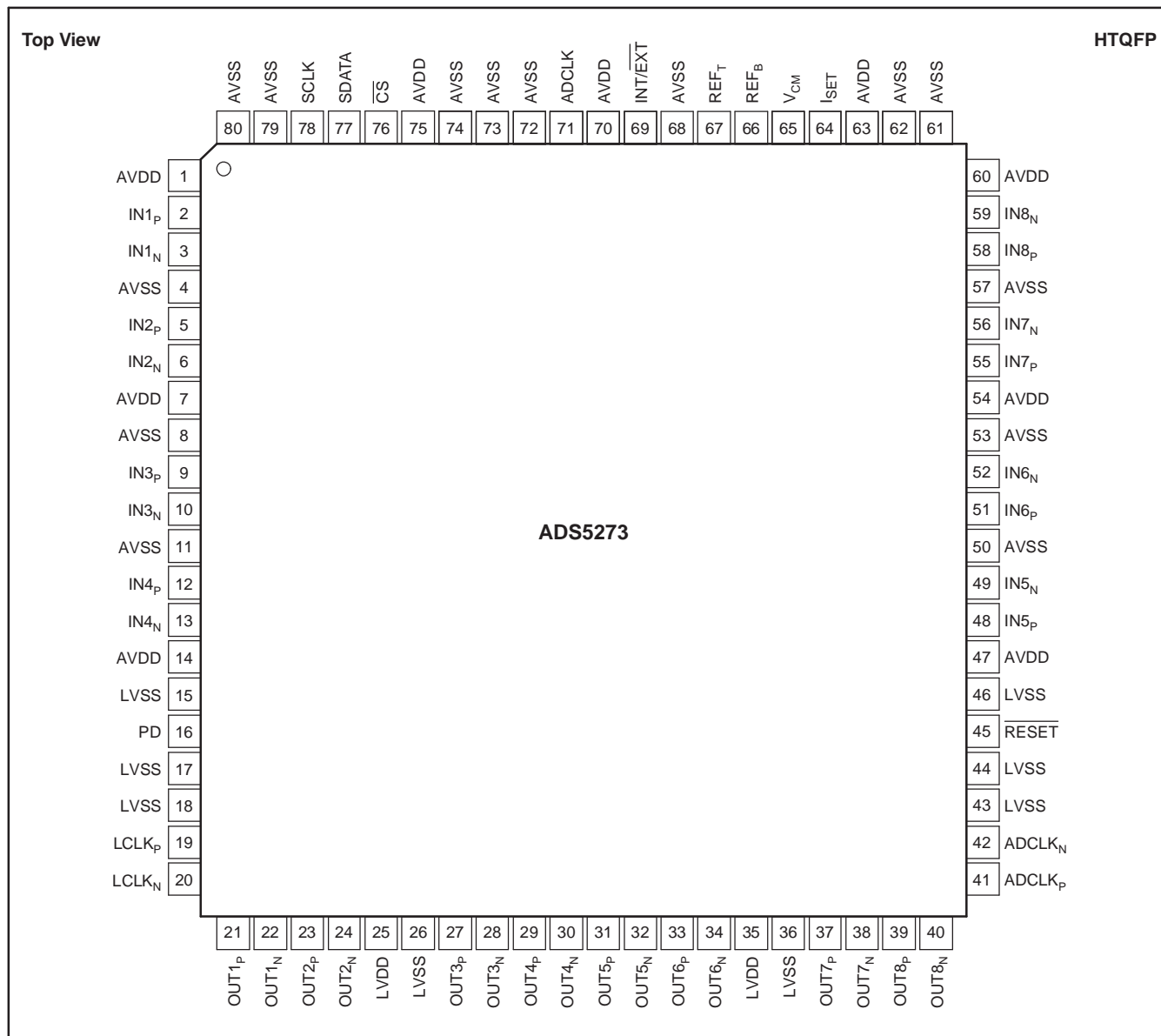

PIN DESCRIPTIONS

NAME	PIN #	I/O	DESCRIPTION
ADCLK	71	I	Data Converter Clock Input
ADCLK _N	42	O	Negative LVDS ADC Clock Output
ADCLK _P	41	O	Positive LVDS ADC Clock Output
AVDD	1, 7, 14, 47, 54, 60, 63, 70, 75	I	Analog Power Supply
AVSS	4, 8, 11, 50, 53, 57, 61, 62, 68, 72–74, 79, 80	I	Analog Ground
\overline{CS}	76	I	Chip Select; 0 = Select, 1 = No Select
IN1 _N	3	I	Channel 1 Differential Analog Input Low
IN1 _P	2	I	Channel 1 Differential Analog Input High
IN2 _N	6	I	Channel 2 Differential Analog Input Low
IN2 _P	5	I	Channel 2 Differential Analog Input High
IN3 _N	10	I	Channel 3 Differential Analog Input Low
IN3 _P	9	I	Channel 3 Differential Analog Input High
IN4 _N	13	I	Channel 4 Differential Analog Input Low
IN4 _P	12	I	Channel 4 Differential Analog Input High
IN5 _N	49	I	Channel 5 Differential Analog Input Low
IN5 _P	48	I	Channel 5 Differential Analog Input High
IN6 _N	52	I	Channel 6 Differential Analog Input Low
IN6 _P	51	I	Channel 6 Differential Analog Input High
IN7 _N	56	I	Channel 7 Differential Analog Input Low
IN7 _P	55	I	Channel 7 Differential Analog Input High
IN8 _N	59	I	Channel 8 Differential Analog Input Low
IN8 _P	58	I	Channel 8 Differential Analog Input High
INT/ \overline{EXT}	69	I	Internal/External Reference Select; 0 = External, 1 = Internal. Weak pull-up to supply.
I _{SET}	64	I/O	Bias Current Setting Resistor of 56.2k Ω to Ground
LVDD	25, 35	I	LVDS Power Supply
LVSS	15, 17, 18, 26, 36, 43, 44, 46	I	LVDS Ground
LCLK _N	20	O	Negative LVDS Clock
LCLK _P	19	O	Positive LVDS Clock
OUT1 _N	22	O	Channel 1 Negative LVDS Data Output
OUT1 _P	21	O	Channel 1 Positive LVDS Data Output
OUT2 _N	24	O	Channel 2 Negative LVDS Data Output
OUT2 _P	23	O	Channel 2 Positive LVDS Data Output
OUT3 _N	28	O	Channel 3 Negative LVDS Data Output
OUT3 _P	27	O	Channel 3 Positive LVDS Data Output
OUT4 _N	30	O	Channel 4 Negative LVDS Data Output
OUT4 _P	29	O	Channel 4 Positive LVDS Data Output
OUT5 _N	32	O	Channel 5 Negative LVDS Data Output
OUT5 _P	31	O	Channel 5 Positive LVDS Data Output
OUT6 _N	34	O	Channel 6 Negative LVDS Data Output
OUT6 _P	33	O	Channel 6 Positive LVDS Data Output
OUT7 _N	38	O	Channel 7 Negative LVDS Data Output
OUT7 _P	37	O	Channel 7 Positive LVDS Data Output
OUT8 _N	40	O	Channel 8 Negative LVDS Data Output
OUT8 _P	39	O	Channel 8 Positive LVDS Data Output
PD	16	I	Power-Down; 0 = Normal, 1 = Power-Down. Weak pull-down to ground.
REF _B	66	I/O	Reference Bottom Voltage (2 Ω resistor in series with a $\geq 0.1\mu\text{F}$ capacitor to ground)
REF _T	67	I/O	Reference Top Voltage (2 Ω resistor in series with a $\geq 0.1\mu\text{F}$ capacitor to ground)
\overline{RESET}	45	I	Reset to Default; 0 = Reset, 1 = Normal. Weak pull-down to ground.
SCLK	78	I	Serial Data Clock
SDATA	77	I	Serial Data Input
V _{CM}	65	O	Common-Mode Output Voltage

DEFINITION OF SPECIFICATIONS

Analog Bandwidth

The analog input frequency at which the spectral power of the fundamental frequency (as determined by FFT analysis) is reduced by 3dB.

Aperture Delay

The delay in time between the rising edge of the input sampling clock and the actual time at which the sampling occurs.

Aperture Uncertainty (Jitter)

The sample-to-sample variation in aperture delay.

Clock Duty Cycle

Pulse width high is the minimum amount of time that the ADCLK pulse should be left in logic '1' state to achieve rated performance. Pulse width low is the minimum time that the ADCLK pulse should be left in a low state (logic '0'). At a given clock rate, these specifications define an acceptable clock duty cycle.

Differential Nonlinearity (DNL)

An ideal ADC exhibits code transitions that are exactly 1 LSB apart. DNL is the deviation of any single LSB transition at the digital output from an ideal 1 LSB step at the analog input. If a device claims to have no missing codes, it means that all possible codes (for a 12-bit converter, 4096 codes) are present over the full operating range.

Effective Number of Bits (ENOB)

The ENOB is a measure of converter performance as compared to the theoretical limit based on quantization noise.

$$\text{ENOB} = \frac{\text{SINAD} - 1.76}{6.02}$$

Integral Nonlinearity (INL)

INL is the deviation of the transfer function from a reference line measured in fractions of 1 LSB using a *best straight line* or *best fit* determined by a least square curve fit. INL is independent from effects of offset, gain or quantization errors.

Maximum Conversion Rate

The encode rate at which parametric testing is performed. This is the maximum sampling rate where certified operation is given.

Minimum Conversion Rate

This is the minimum sampling rate where the ADC still works.

Signal-to-Noise and Distortion (SINAD)

SINAD is the ratio of the power of the fundamental (P_S) to the power of all the other spectral components including noise (P_N) and distortion (P_D), but not including dc.

$$\text{SINAD} = 10\text{Log}_{10} \frac{P_S}{P_N + P_D}$$

SINAD is either given in units of dBc (dB to carrier) when the absolute power of the fundamental is used as the reference, or dBFS (dB to full-scale) when the power of the fundamental is extrapolated to the full-scale range of the converter.

Signal-to-Noise Ratio (SNR)

SNR is the ratio of the power of the fundamental (P_S) to the noise floor power (P_N), excluding the power at dc and the first eight harmonics.

$$\text{SNR} = 10\text{Log}_{10} \frac{P_S}{P_N}$$

SNR is either given in units of dBc (dB to carrier) when the absolute power of the fundamental is used as the reference, or dBFS (dB to full-scale) when the power of the fundamental is extrapolated to the full-scale range of the converter.

Spurious-Free Dynamic Range

The ratio of the power of the fundamental to the highest other spectral component (either spur or harmonic). SFDR is typically given in units of dBc (dB to carrier).

Two-Tone, Third-Order Intermodulation Distortion

Two-tone IMD3 is the ratio of power of the fundamental (at frequencies f_1 and f_2) to the power of the worst spectral component of third-order intermodulation distortion at either frequency $2f_1 - f_2$ or $2f_2 - f_1$. IMD3 is either given in units of dBc (dB to carrier) when the absolute power of the fundamental is used as the reference, or dBFS (dB to full-scale) when the power of the fundamental is extrapolated to the full-scale range of the converter.

TYPICAL CHARACTERISTICS

$T_{MIN} = -40^{\circ}C$ and $T_{MAX} = +85^{\circ}C$. Typical values are at $T_A = +25^{\circ}C$, clock frequency = 70MSPS, 50% clock duty cycle, AVDD = 3.3V, LVDD = 3.3V, -1dBFS, $I_{SET} = 56.2k\Omega$, internal voltage reference, LVDS buffer current at 3.5mA per channel, 16kFFT, and 8 averages, unless otherwise noted.

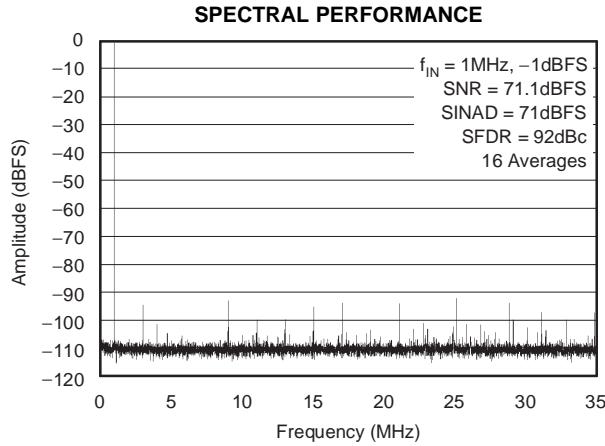

Figure 1.

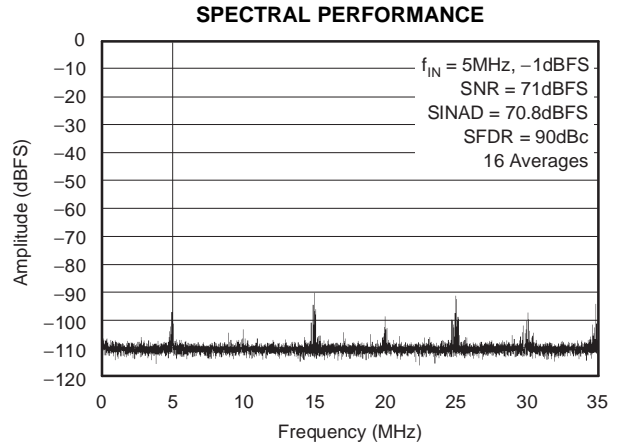

Figure 2.

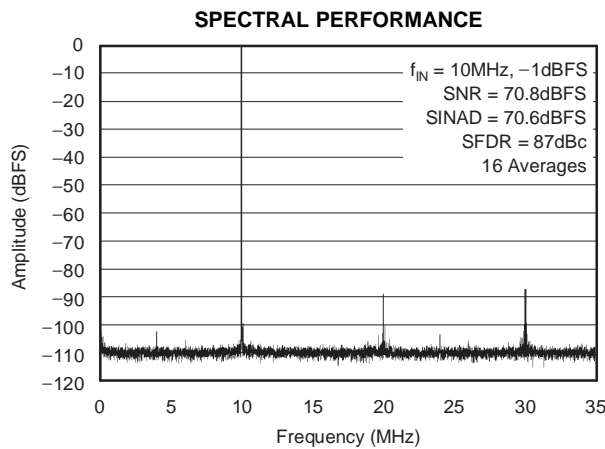

Figure 3.

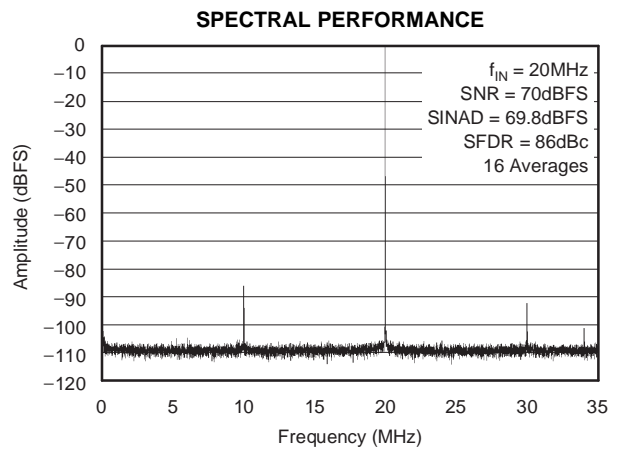

Figure 4.

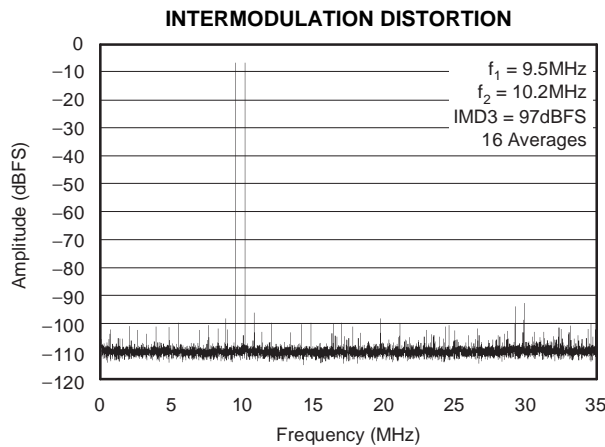

Figure 5.

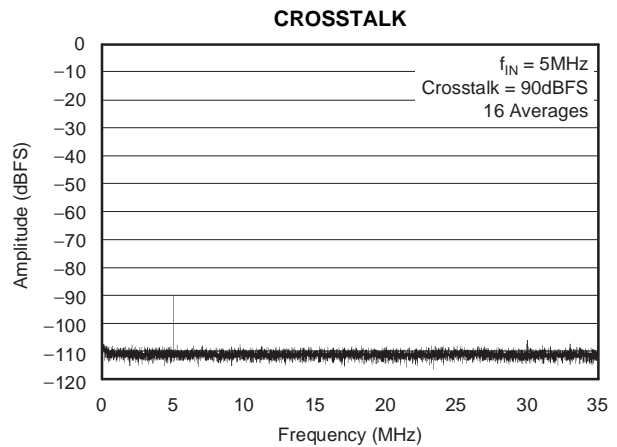

Figure 6.

TYPICAL CHARACTERISTICS (continued)

$T_{MIN} = -40^{\circ}C$ and $T_{MAX} = +85^{\circ}C$. Typical values are at $T_A = +25^{\circ}C$, clock frequency = 70MSPS, 50% clock duty cycle, AVDD = 3.3V, LVDD = 3.3V, -1dBFS, $I_{SET} = 56.2k\Omega$, internal voltage reference, LVDS buffer current at 3.5mA per channel, 16kFFT, and 8 averages, unless otherwise noted.

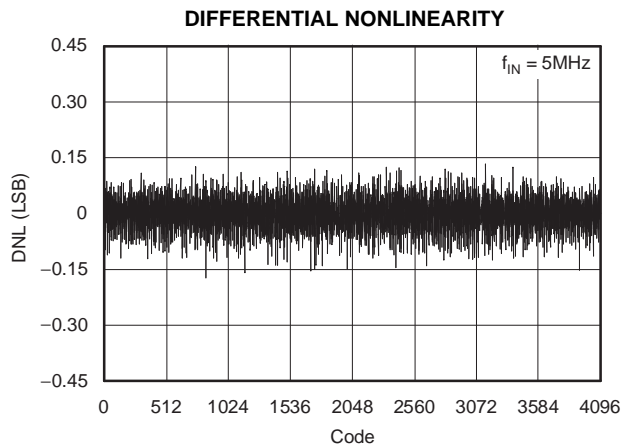

Figure 7.

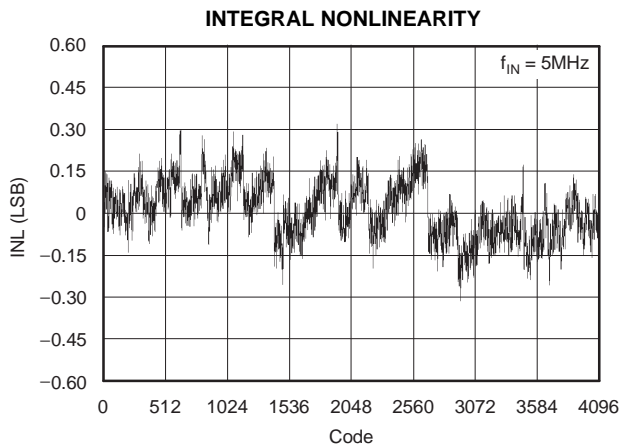

Figure 8.

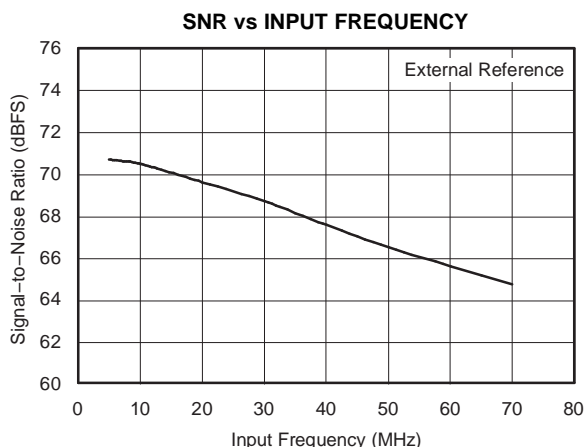

Figure 9.

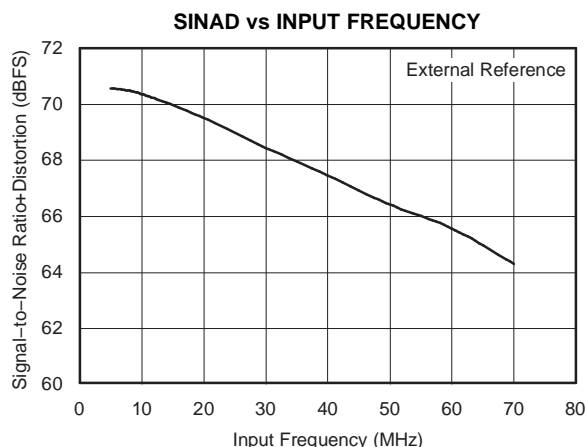

Figure 10.

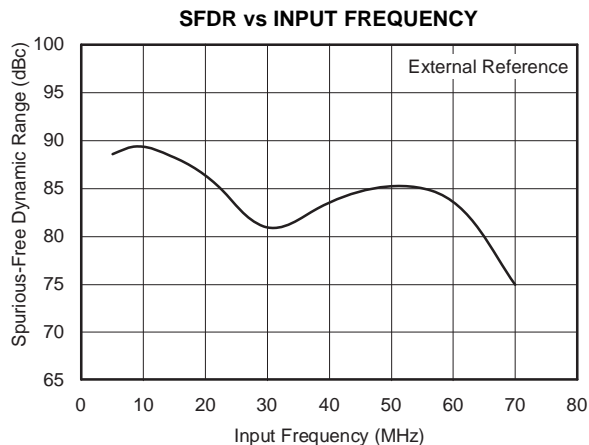

Figure 11.

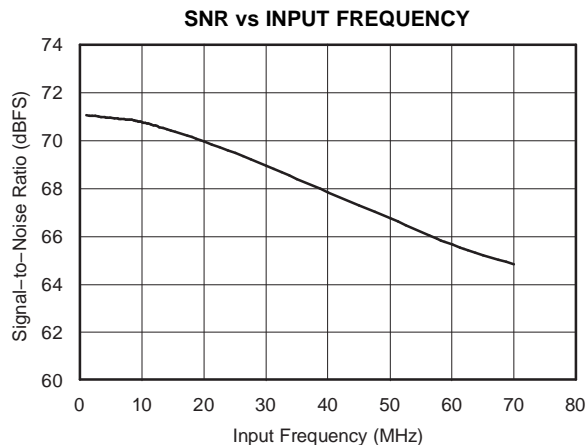

Figure 12.

TYPICAL CHARACTERISTICS (continued)

$T_{MIN} = -40^{\circ}C$ and $T_{MAX} = +85^{\circ}C$. Typical values are at $T_A = +25^{\circ}C$, clock frequency = 70MSPS, 50% clock duty cycle, AVDD = 3.3V, LVDD = 3.3V, -1dBFS, $I_{SET} = 56.2k\Omega$, internal voltage reference, LVDS buffer current at 3.5mA per channel, 16kFFT, and 8 averages, unless otherwise noted.

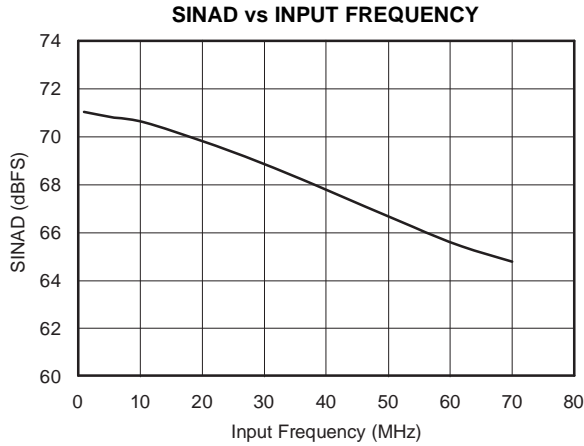

Figure 13.

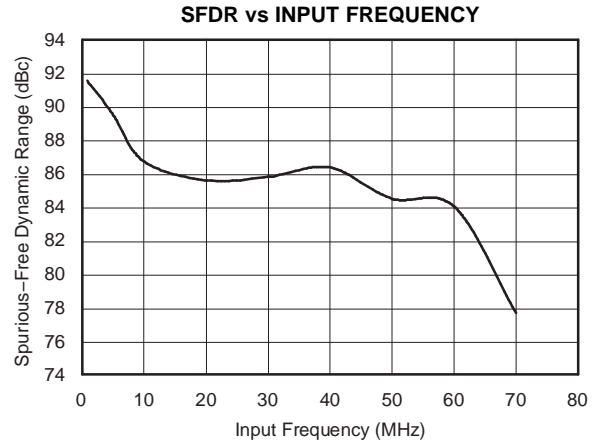

Figure 14.

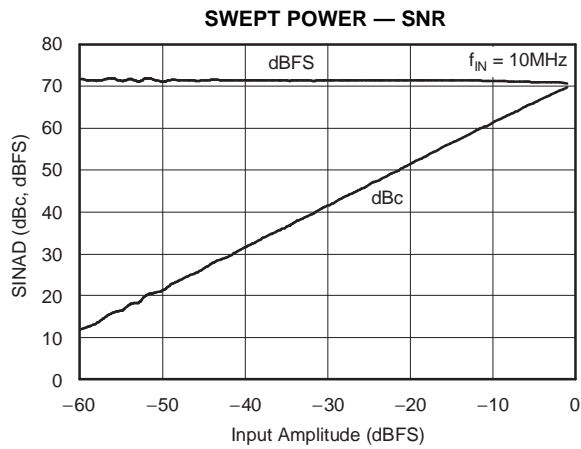

Figure 15.

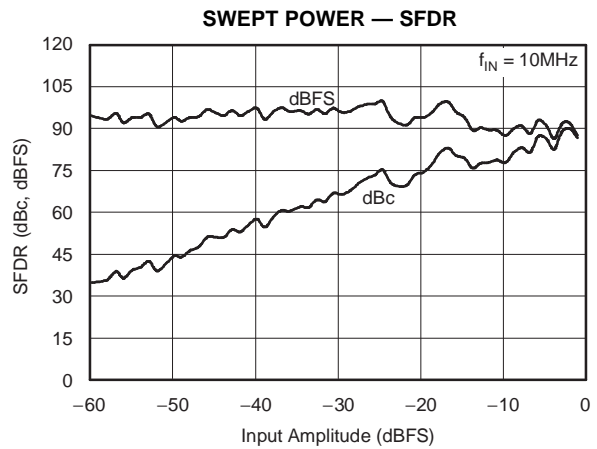

Figure 16.

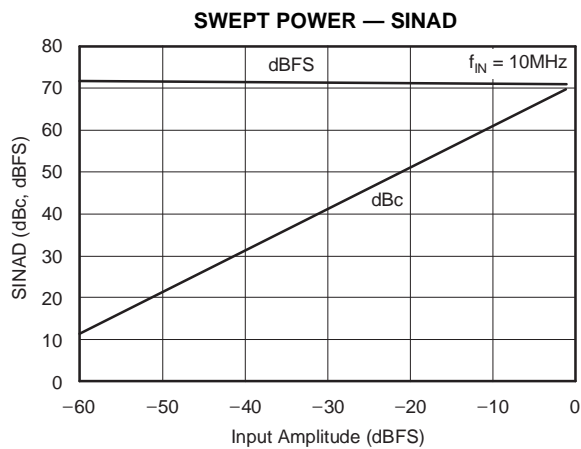

Figure 17.

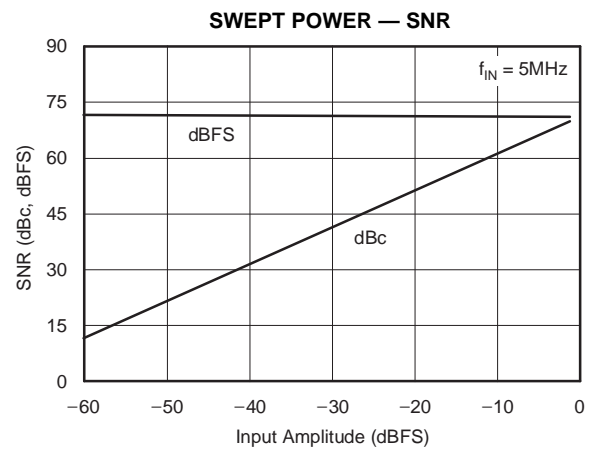

Figure 18.

TYPICAL CHARACTERISTICS (continued)

$T_{MIN} = -40^{\circ}C$ and $T_{MAX} = +85^{\circ}C$. Typical values are at $T_A = +25^{\circ}C$, clock frequency = 70MSPS, 50% clock duty cycle, AVDD = 3.3V, LVDD = 3.3V, -1dBFS, $I_{SET} = 56.2k\Omega$, internal voltage reference, LVDS buffer current at 3.5mA per channel, 16kFFT, and 8 averages, unless otherwise noted.

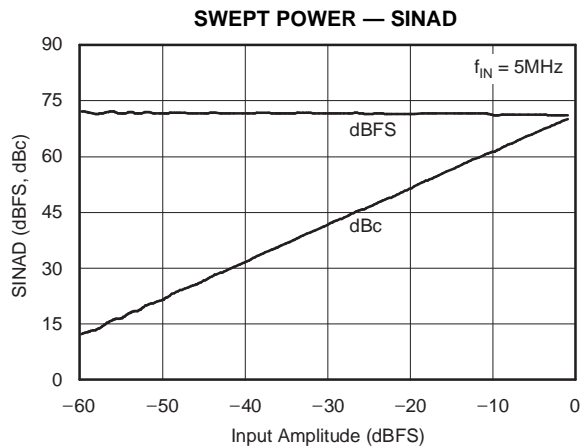

Figure 19.

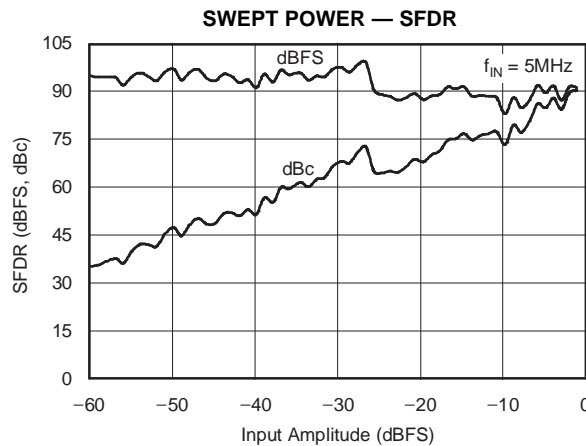

Figure 20.

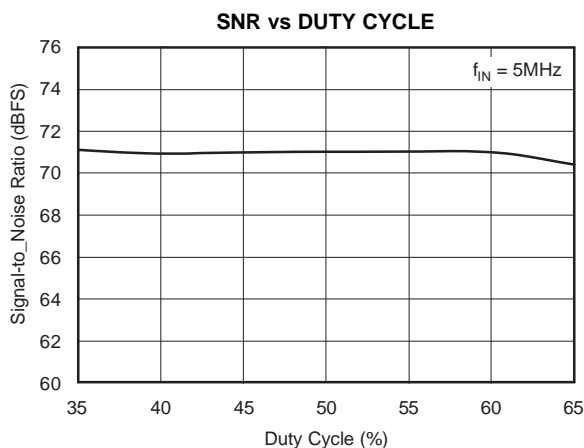

Figure 21.

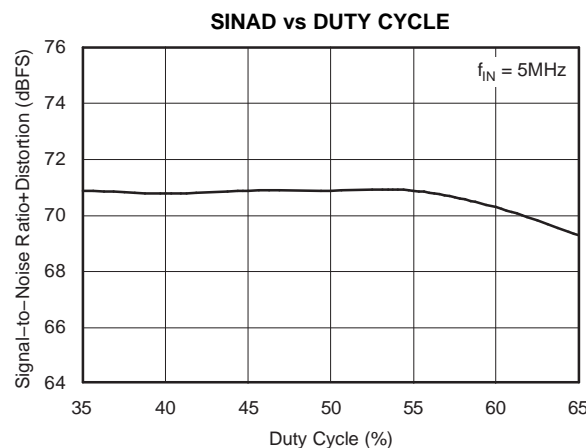

Figure 22.

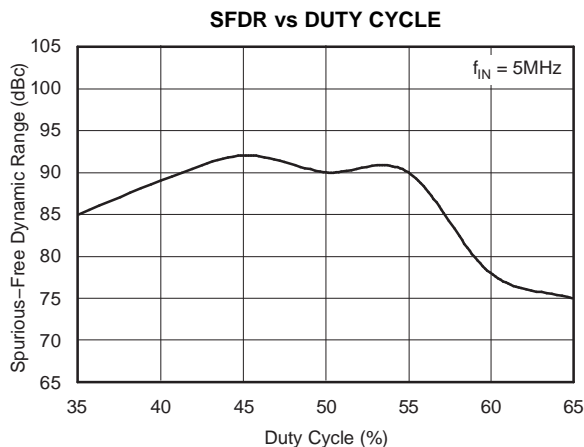

Figure 23.

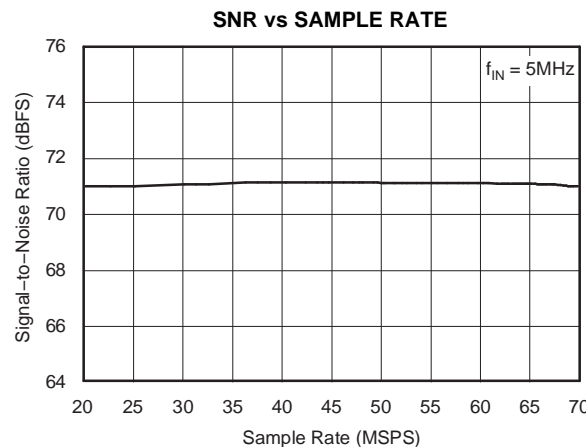

Figure 24.

TYPICAL CHARACTERISTICS (continued)

$T_{MIN} = -40^{\circ}C$ and $T_{MAX} = +85^{\circ}C$. Typical values are at $T_A = +25^{\circ}C$, clock frequency = 70MSPS, 50% clock duty cycle, AVDD = 3.3V, LVDD = 3.3V, $-1dBFS$, $I_{SET} = 56.2k\Omega$, internal voltage reference, LVDS buffer current at 3.5mA per channel, 16kFFT, and 8 averages, unless otherwise noted.

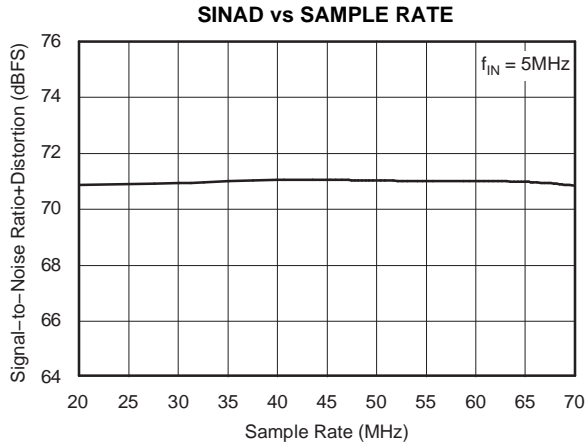

Figure 25.

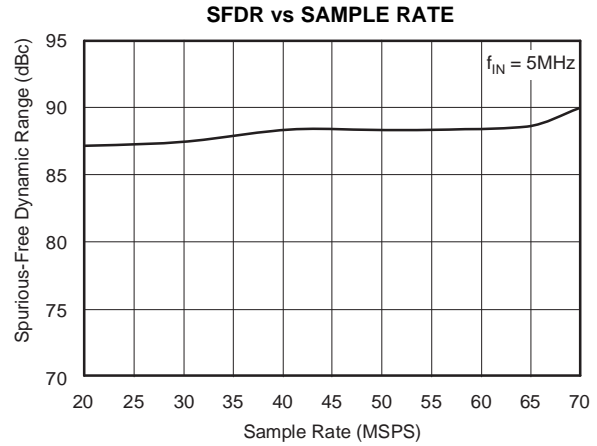

Figure 26.

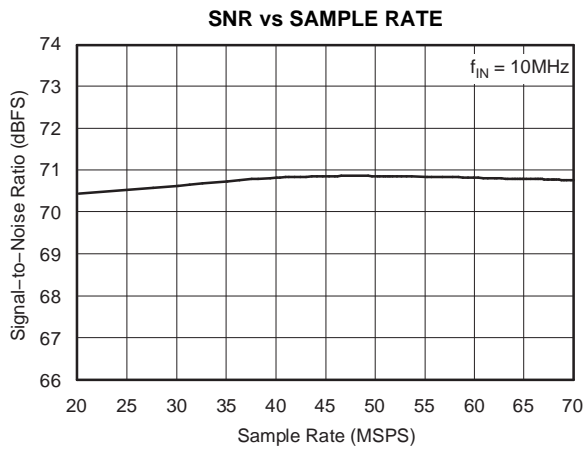

Figure 27.

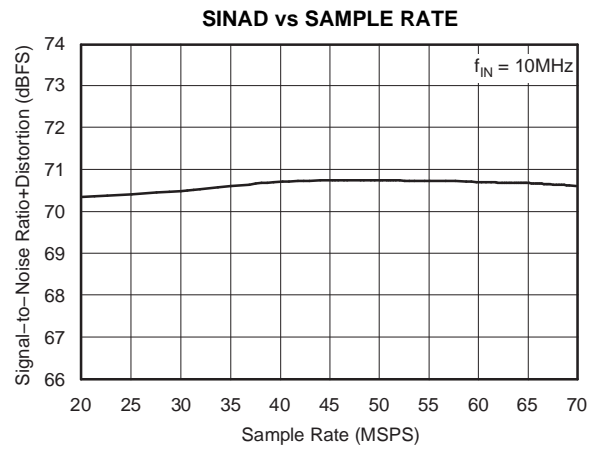

Figure 28.

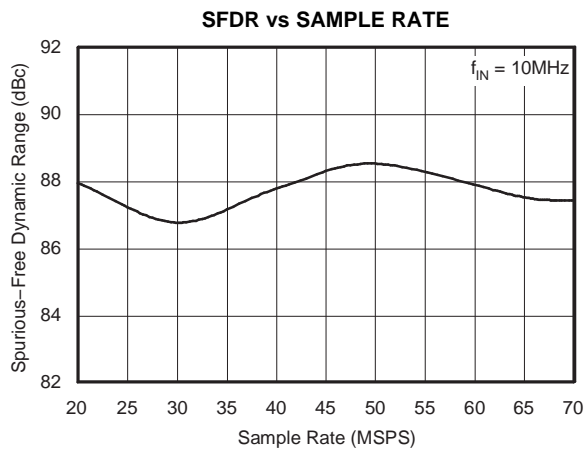

Figure 29.

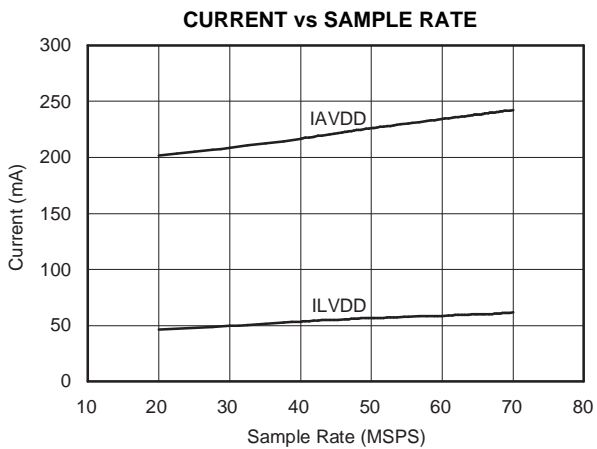

Figure 30.

TYPICAL CHARACTERISTICS (continued)

$T_{MIN} = -40^{\circ}C$ and $T_{MAX} = +85^{\circ}C$. Typical values are at $T_A = +25^{\circ}C$, clock frequency = 70MSPS, 50% clock duty cycle, AVDD = 3.3V, LVDD = 3.3V, -1dBFS, $I_{SET} = 56.2k\Omega$, internal voltage reference, LVDS buffer current at 3.5mA per channel, 16kFFT, and 8 averages, unless otherwise noted.

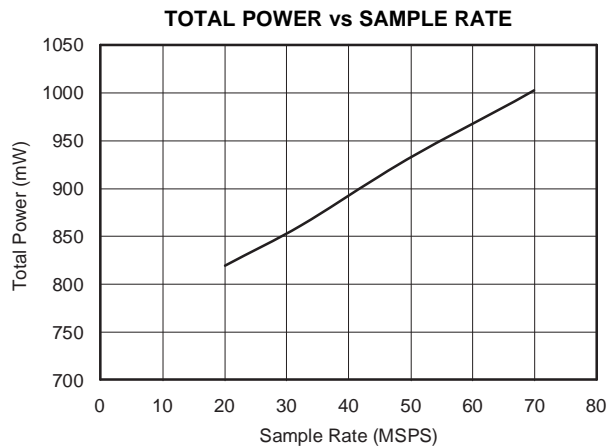

Figure 31.

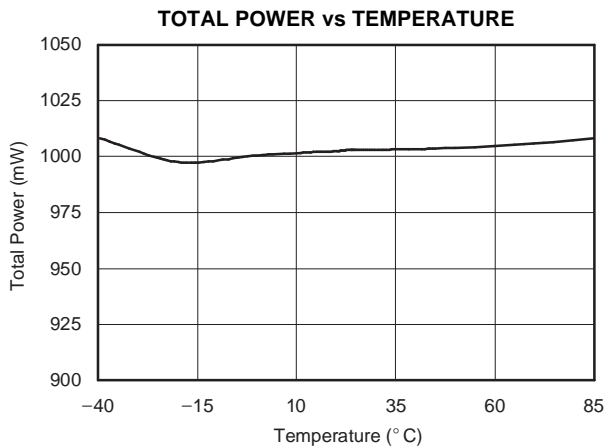

Figure 32.

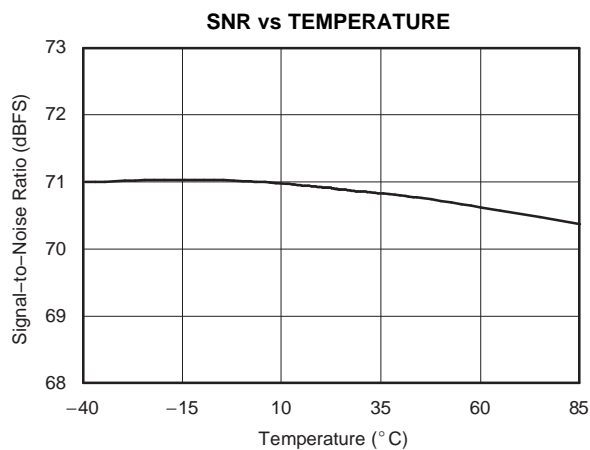

Figure 33.

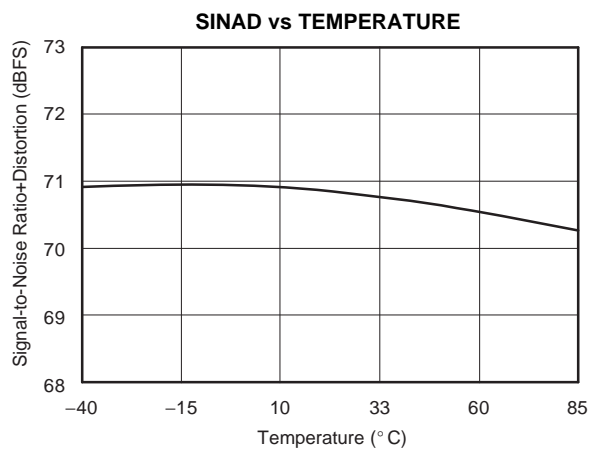

Figure 34.

THEORY OF OPERATION

OVERVIEW

The ADS5273 is an 8-channel, high-speed, CMOS ADC. It consists of a high-performance sample-and-hold circuit at the input, followed by a 12-bit ADC. The 12 bits given out by each channel are serialized and sent out on a single pair of pins in LVDS format. All eight channels of the ADS5273 operate from a single clock referred to as ADCLK. The sampling clocks for each of the eight channels are generated from the input clock using a carefully matched clock buffer tree. The 12x clock required for the serializer is generated internally from ADCLK using a phase lock loop (PLL). A 6x and a 1x clock are also output in LVDS format along with the data to enable easy data capture. The ADS5273 operates from internally-generated reference voltages that are trimmed to improve performance to a high level of accuracy. This feature eliminates the need for external routing of reference lines and also improves matching of the gain across devices. The nominal values of REF_T and REF_B are 1.95V and 0.95V, respectively. These values imply that a differential input of $-1V$ corresponds to the zero code of the ADC, and a differential input of $+1V$ corresponds to the full-scale code (4095 LSB). V_{CM} (common-mode voltage of REF_T and REF_B) is also made available externally through a pin, and is nominally 1.45V.

The ADC employs a pipelined converter architecture consisting of a combination of multi-bit and single-bit internal stages. Each stage feeds its data into the digital error correction logic, ensuring excellent differential linearity and no missing codes at the 12-bit level. The pipeline architecture results in a data latency of 6.5 clock cycles.

The output of the ADC goes to a serializer that operates from a 12x clock generated by the PLL. The 12 data bits from each channel are serialized and sent LSB first. In addition to serializing the data, the serializer also generates a 1x clock and a 6x clock. These clocks are generated in the same way the serialized data is generated, so these clocks maintain perfect synchronization with the data. The data and clock outputs of the serializer are buffered externally using LVDS buffers. Using LVDS buffers to transmit

data externally has multiple advantages, such as a reduced number of output pins (saving routing space on the board), reduced power consumption, and reduced effects of digital noise coupling to the analog circuit inside the ADS5273.

The ADS5273 operates from two sets of supplies and grounds. The analog supply/ground set is denoted as AVDD/AVSS, while the digital set is denoted by LVDD/LVSS.

DRIVING THE ANALOG INPUTS

The analog input biasing is shown in Figure 35. The inputs are biased internally using two 600 Ω resistors to enable ac-coupling. A resistor greater than 20 Ω is recommended in series with each input pin.

A 4pF sampling capacitor is used to sample the inputs. The choice of the external ac coupling capacitor is dictated by the attenuation at the lowest desired input frequency of operation. The attenuation resulting from using a 10nF ac-coupling capacitor is 0.04%.

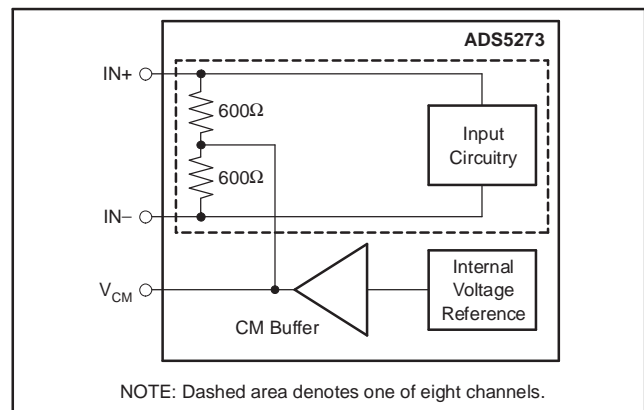

Figure 35. Analog Input Bias Circuitry

If the input is dc-coupled, then the output common-mode voltage of the circuit driving the ADS5273 should match the V_{CM} (which is provided as an output pin) to within $\pm 50mV$. It is recommended that the output common-mode of the driving circuit be derived from the V_{CM} provided by the device.

Figure 36 shows a detailed RLC model of the sample-and-hold circuit. The circuit operates in two phases. In the sample phase, the input is sampled on two capacitors that are nominally 4pF. The sampling circuit consists of a low-pass RC filter at the input to filter out noise components that might be differentially coupled on the input pins. The next phase is the hold phase wherein the voltage sampled on the capacitors is transferred (using the amplifier) to a subsequent pipeline ADC stage.

INPUT OVER-VOLTAGE RECOVERY

The differential full-scale range supported by the ADS5273 is nominally 2.03V. The ADS5273 is specially designed to handle an over-voltage condition where the differential peak-to-peak voltage can exceed up to twice the ADC full-scale range. If the input common-mode is not considerably off from V_{CM} during overload (less than 300mV around the nominal value of 1.45V), recovery from an

over-voltage pulse input of twice the amplitude of a full-scale pulse is expected to be within three clock cycles when the input switches from overload to zero strength. All of the amplifiers in the sample-and-hold amplifier (SHA) and ADC are specially designed for excellent recovery from an overload signal.

In most applications, the ADC inputs are driven with differential sinusoidal inputs. While the pulse-type signal remains at peak overload conditions throughout its HIGH state, the sinusoid signal only attains peak overload intermittently, at its minima and maxima. This condition is much less severe for the ADC input and the recovery of the ADC output (to 1% of full-scale around the expected code). This typically happens within the second clock when the input is driven with a sinusoid of amplitude equal to twice that of the ADC differential full-scale range.

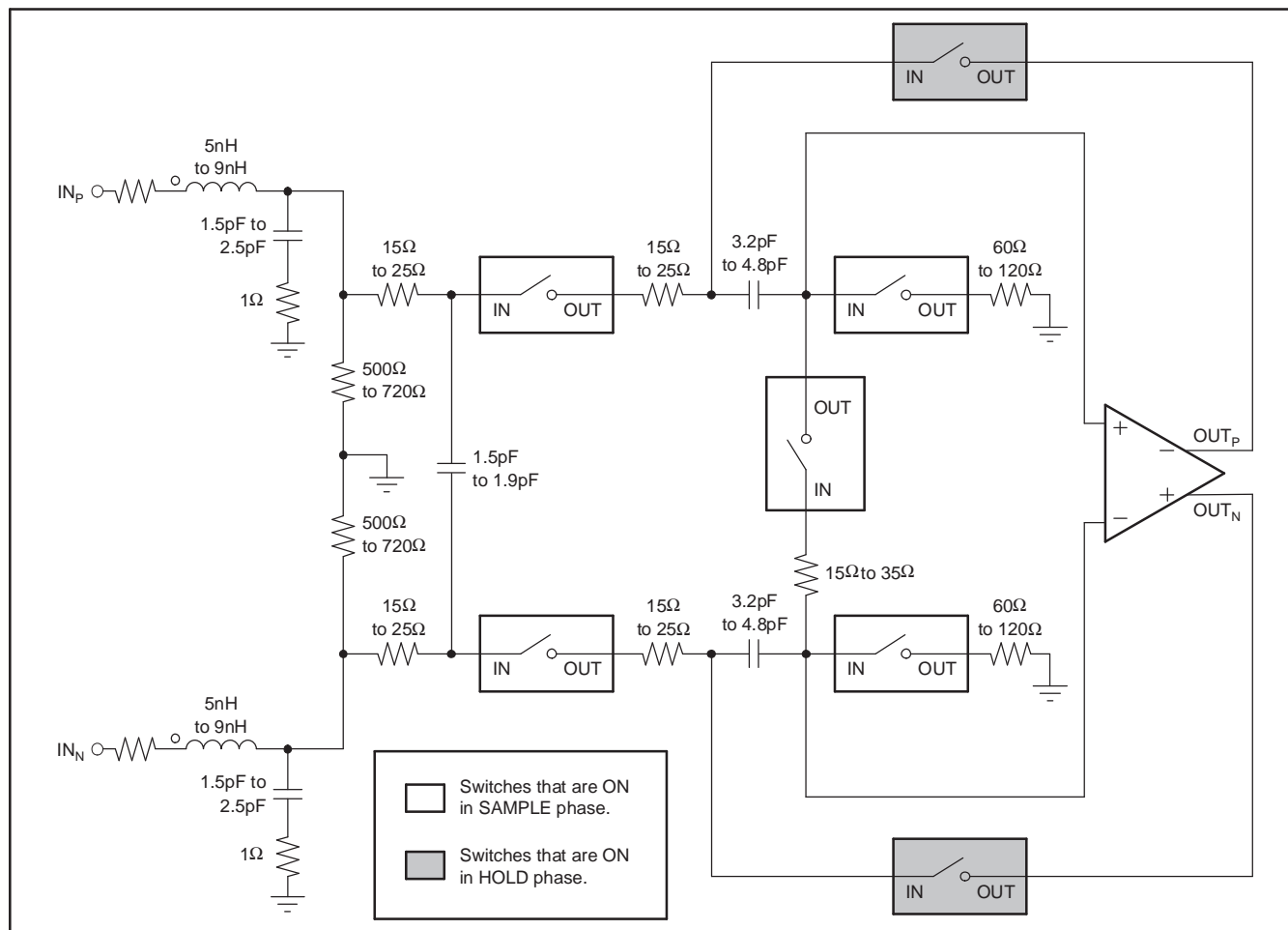

Figure 36. Overall Structure of the Sample-and-Hold Circuit

REFERENCE CIRCUIT DESIGN

The digital beam-forming algorithm relies on gain matching across all receiver channels. For example, a typical system has 12 octal ADCs on the board. In such a case, it is critical to ensure that the gain is matched, essentially requiring the reference voltages seen by all the ADCs to be the same. Matching references within the eight channels of a chip is done by using a single internal reference voltage buffer. Trimming the reference voltages on each chip during production ensures the reference voltages are well-matched across different chips.

All bias currents required for the internal operation of the device are set using an external resistor to ground at the I_{SET} pin. Using a 56.2k Ω resistor on I_{SET} generates an internal reference current of 20 μ A. This current is mirrored internally to generate the bias current for the internal blocks. Using a larger external resistor at I_{SET} reduces the reference bias current, and thereby scales down the device operating power. However, it is recommended that the external resistor be within 10% of the specified value of 56.2k Ω so that the internal bias margins for the various blocks are proper.

Buffering the internal bandgap voltage also generates a voltage called V_{CM} , which is set to the midlevel of REF_T and REF_B , and is accessible on a pin. It is meant as a reference voltage to derive the input common-mode in case the input is directly coupled. It can also be used to derive the reference common-mode voltage in the external reference mode.

When using the internal reference mode, a 2 Ω resistor should be added between the reference pins (REF_T and REF_B) and the decoupling capacitor, as shown in Figure 37. If the device is used in the external reference mode, this 2 Ω resistor is not required.

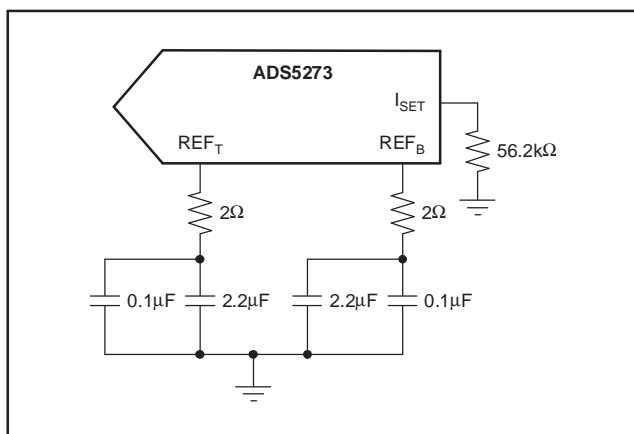

Figure 37. Internal Reference Mode

The device also supports the use of external reference voltages. This mode involves forcing REF_T and REF_B externally. In this mode, the internal reference buffer is tri-stated. Since the switching current for the eight ADCs comes from the externally-forced references, it is possible for the performance to be slightly less than when the internal references are used. It should be noted that in this mode, V_{CM} and I_{SET} continue to be generated from the internal bandgap voltage, as in the internal reference mode. Therefore, it is important to ensure that the common-mode voltage of the externally-forced reference matches to within 50mV of V_{CM} . The state of the reference voltages during various combinations of PD and INT/EXT is shown in Table 1.

Table 1. State of Reference Voltages for Various Combinations of PD and INT/EXT

PD	0	0	1	1
INT/EXT	0	1	0	1
REF_T	Tri-State	1.95V	Tri-State	Tri-State
REF_B	Tri-State	0.95V	Tri-State	Tri-State
V_{CM}	1.45V	1.45V	Tri-State ⁽¹⁾	Tri-State ⁽¹⁾

(1) Weak pull-down (approximately 5k Ω) to ground.

CLOCKING

The eight channels on the chip operate from a single ADCLK input. To ensure that the aperture delay and jitter are same for all the channels, a clock tree network is used to generate individual sampling clocks to each channel. The clock paths for all the channels are matched from the source point all the way to the sample-and-hold amplifier. This ensures that the performance and timing for all the channels are identical. The use of the clock tree for matching introduces an aperture delay, which is defined as the delay between the rising edge of ADCLK and the actual instant of sampling. The aperture delays for all the channels are matched to the best possible extent. However, a mismatch of ± 20 ps ($\pm 3\sigma$) could exist between the aperture instants of the eight ADCs within the same chip. However, the aperture delays of ADCs across two different chips can be several hundred picoseconds apart. Another critical specification is the aperture jitter that is defined as the uncertainty of the sampling instant. The gates in the clock path are designed to provide an rms jitter of approximately 1ps.

Ideally, the input ADCLK should have a 50% duty cycle. However, while routing ADCLK to different components onboard, the duty cycle of the ADCLK reaching the ADS5273 could deviate from 50%. A smaller (or larger) duty cycle reduces the time available for sample or hold phases of each circuit, and is therefore not optimal. For this reason, the

internal PLL is used to generate an internal clock that has 50% duty cycle. The input sampling instant, however, is determined by the rising edge of the external clock and is not affected by jitter in the PLL. In addition to generating a 50% duty cycle clock for the ADC, the PLL also generates a 12x clock that is used by the serializer to convert the parallel data from the ADC to a serial stream of bits.

The use of the PLL automatically dictates the minimum sample rate to be about 20MSPS. The PLL also requires the input clock to be free-running. If the input clock is momentarily stopped (for a duration of less than 300ns) then the PLL would require approximately 10 μ s to lock back to the input clock frequency.

LVDS BUFFERS

The LVDS buffer has two current sources, as shown in Figure 38. OUT_P and OUT_N are loaded externally by a resistive load that is ideally about 100 Ω . Depending on whether the data is 0 or 1, the currents are directed in one direction or the other through the resistor. The LVDS buffer has four current settings. The default current setting is 3.5mA, and provides a differential drop of about ± 350 mV across the 100 Ω resistor.

The single-ended output impedance of the LVDS drivers is very high because they are current-source driven. If there are excessive reflections from the receiver, it might be necessary to place a 100 Ω termination resistor across the outputs of the LVDS drivers to minimize the effect of reflections. In such a situation, the output current of the LVDS drivers can be increased to regain the output swing.

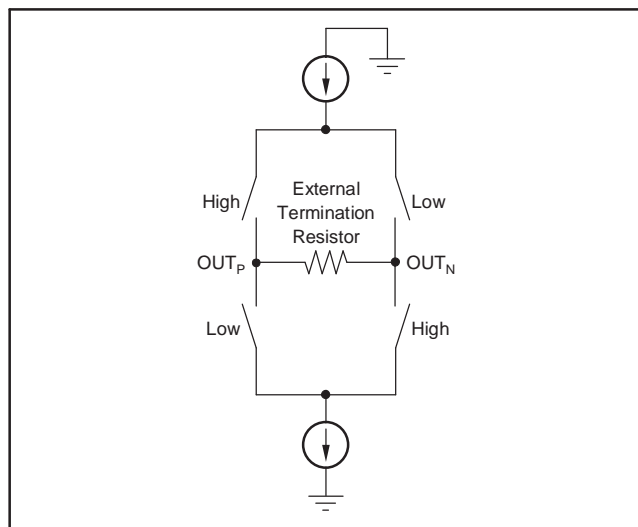

Figure 38. LVDS Buffer

The LVDS buffer receives data from a serializer that takes the output data from each channel and

serializes it into a single data stream. For a clock frequency of 70MHz, the data rate output of the serializer is 840Mbps. The data comes out LSB first, with a register programmability that allows it to revert to MSB first. The serializer also transmits a 1x clock and a 6x clock. The 6x clock (denoted as $LCLK_P/LCLK_N$) is meant to synchronize the capture of the LVDS data.

Deskew mode can be enabled as well, using a register setting. This mode gives out a data stream of alternate 0s and 1s and can be used to determine the relative delay between the 6x clock and the output data for optimum capture. A 1x clock is also generated by the serializer and transmitted through the LVDS buffer. The 1x clock (referred to as $ADCLK_P/ADCLK_N$) is used to determine the start of the 12-bit data frame. Sync mode (enabled through a register setting) gives out a data of six 0s followed by six 1s. Using this mode, the 1x clock can be used to determine the start of the data frame. In addition to the deskew mode pattern and the sync mode pattern, a custom pattern can be defined by the user and output from the LVDS buffer. The LVDS buffers are tri-stated in the power-down mode. The LVDS outputs are weakly forced to 1.2V through 10k Ω resistors (from each output pin to 1.2V).

NOISE COUPLING ISSUES

High-speed mixed signals are sensitive to various types of noise coupling. One of the main sources of noise is the switching noise from the serializer and the output buffers. Maximum care is taken to isolate these noise sources from the sensitive analog blocks. As a starting point, the analog and digital domains of the chip are clearly demarcated. AVDD and AVSS are used to denote the supplies for the analog sections, while LVDD and LVSS are used to denote the digital supplies. Care is taken to ensure that there is minimal interaction between the supply sets within the device. The extent of noise coupled and transmitted from the digital to the analog sections depends on the following:

1. The effective inductance of each of the supply/ground sets.
2. The isolation between the digital and analog supply/ground sets.

Smaller effective inductance of the supply/ground pins leads to better noise suppression. For this reason, multiple pins are used to drive each supply/ground. It is also critical to ensure that the impedances of the supply and ground lines onboard are kept to the minimum possible values. Use of ground planes in the board as well as large decoupling capacitors between the supply and ground lines are necessary to get the best possible SNR from the device.

It is recommended that the isolation be maintained onboard by using separate supplies to drive AVDD and LVDD, as well as separate ground planes for AVSS and LVSS.

The use of LVDS buffers reduces the injected noise considerably, compared to CMOS buffers. The current in the LVDS buffer is independent of the direction of switching. Also, the low output swing, as well as the differential nature of the LVDS buffer, results in low-noise coupling.

POWER-DOWN MODE

The ADS5273 has a power-down pin, referred to as PD. Pulling PD high causes the device to enter the power-down mode. In this mode, the reference and clock circuitry, as well as all the channels, are powered down. Device power consumption drops to less than 100mW in this mode. In power-down mode, the internal buffers driving REF_T and REF_B are tri-stated and their outputs are forced to a voltage roughly equal to half of the voltage on AVDD. Speed of recovery from power-down mode depends on the value of the external capacitance on the REF_T and REF_B pins. For capacitances on REF_T and REF_B less than 1μF, the reference voltages settle to within 1% of their steady-state values in less than 500μs. Individual channels can also be selectively powered down by programming registers.

The ADS5273 also has an internal circuit that monitors the state of stopped clocks. If ADCLK is stopped (or if it runs at a speed less than 3MHz), this monitoring circuit generates a logic signal that puts the device in a power-down state. As a result, the power consumption of the device is reduced to less than 100mW when ADCLK is stopped. The recovery from such a power-down could take approximately 100μs; this is described in [Table 2](#).

RESET

After the supplies have stabilized, it is required to give the device an active RESET pulse. This results in all internal registers getting reset to their default value of 0 (inactive). Without a reset, it is possible that some registers might be in their non-default state on power-up. This could cause the device to malfunction. When a reset is active, the device outputs 0 code on all channels. However, the LVDS output clocks are unaffected by reset.

LAYOUT OF PCB WITH PowerPAD THERMALLY-ENHANCED PACKAGES

The ADS5273 is housed in an 80-lead PowerPAD thermally-enhanced package. To make optimum use of the thermal efficiencies designed into the PowerPAD package, the printed circuit board (PCB) must be designed with this technology in mind. Please refer to PowerPAD brief [SLMA004](#), *PowerPAD Made Easy* (available for download at [www.ti.com](#)), which addresses the specific considerations required when integrating a PowerPAD package into a PCB design. For more detailed information, including thermal modeling and repair procedures, please see technical brief [SLMA002](#), *PowerPAD Thermally-Enhanced Package* ([www.ti.com](#)).

Interfacing High-Speed LVDS Outputs (SBOA104), an application report discussing the design of a simple deserializer that can deserialize LVDS outputs up to 840Mbps, can be found on the TI web site ([www.ti.com](#)).

CONNECTING HIGH-SPEED, MULTI-CHANNEL ADCs TO XILINX FPGAs

A separate application report (XAPP774) describing how to connect TI's high-speed, multi-channel ADCs with serial LVDS outputs to Xilinx FPGAs can be downloaded directly from the Xilinx web site (<http://www.xilinx.com>).

Table 2. Time Constraints Associated with Device Recovery from Power-Down and Clock Stoppage

DESCRIPTION	TYP	REMARKS
Recovery from power-down mode (PD = 1 to PD = 0).	500μs	Capacitors on REF _T and REF _B less than 1μF.
Recovery from momentary clock stoppage (< 300ns).	10μs	
Recovery from extended clock stoppage (> 300ns).	100μs	

Revision History

Changes from Revision C (September 2005) to Revision D Page

- Updated *Absolute Maximum Ratings* table: added entries for Digital Input Pins, Set 1 and Set 2 and added footnote 3... 2
-

Changes from Revision B (August 2005) to Revision C Page

- Deleted *parallel* from first paragraph of Description section. 1
 - Changed front page figure. 1
 - Changed unit values in Lead Temperature and Storage Temperature rows in Absolute Maximum Ratings table..... 2
 - Deleted condition value for C₀ row in LVDS table..... 7
 - Changed Figure 30. 18
 - Changed 2.0ps to 20ps and added ($\pm 3\sigma$) to seventh sentence of first paragraph of *Clocking* section in Theory of Operation. 22
-

PACKAGING INFORMATION

Orderable Device	Status ⁽¹⁾	Package Type	Package Drawing	Pins	Package Qty	Eco Plan ⁽²⁾	Lead/Ball Finish	MSL Peak Temp ⁽³⁾
ADS5273IPFP	ACTIVE	HTQFP	PFP	80	96	Green (RoHS & no Sb/Br)	CU NIPDAU	Level-3-260C-168 HR
ADS5273IPFPG4	ACTIVE	HTQFP	PFP	80	96	Green (RoHS & no Sb/Br)	CU NIPDAU	Level-3-260C-168 HR
ADS5273IPFPT	ACTIVE	HTQFP	PFP	80	250	Green (RoHS & no Sb/Br)	CU NIPDAU	Level-3-260C-168 HR
ADS5273IPFPTG4	ACTIVE	HTQFP	PFP	80	250	Green (RoHS & no Sb/Br)	CU NIPDAU	Level-3-260C-168 HR

⁽¹⁾ The marketing status values are defined as follows:

ACTIVE: Product device recommended for new designs.

LIFEBUY: TI has announced that the device will be discontinued, and a lifetime-buy period is in effect.

NRND: Not recommended for new designs. Device is in production to support existing customers, but TI does not recommend using this part in a new design.

PREVIEW: Device has been announced but is not in production. Samples may or may not be available.

OBSOLETE: TI has discontinued the production of the device.

⁽²⁾ Eco Plan - The planned eco-friendly classification: Pb-Free (RoHS), Pb-Free (RoHS Exempt), or Green (RoHS & no Sb/Br) - please check <http://www.ti.com/productcontent> for the latest availability information and additional product content details.

TBD: The Pb-Free/Green conversion plan has not been defined.

Pb-Free (RoHS): TI's terms "Lead-Free" or "Pb-Free" mean semiconductor products that are compatible with the current RoHS requirements for all 6 substances, including the requirement that lead not exceed 0.1% by weight in homogeneous materials. Where designed to be soldered at high temperatures, TI Pb-Free products are suitable for use in specified lead-free processes.

Pb-Free (RoHS Exempt): This component has a RoHS exemption for either 1) lead-based flip-chip solder bumps used between the die and package, or 2) lead-based die adhesive used between the die and leadframe. The component is otherwise considered Pb-Free (RoHS compatible) as defined above.

Green (RoHS & no Sb/Br): TI defines "Green" to mean Pb-Free (RoHS compatible), and free of Bromine (Br) and Antimony (Sb) based flame retardants (Br or Sb do not exceed 0.1% by weight in homogeneous material)

⁽³⁾ MSL, Peak Temp. -- The Moisture Sensitivity Level rating according to the JEDEC industry standard classifications, and peak solder temperature.

Important Information and Disclaimer:The information provided on this page represents TI's knowledge and belief as of the date that it is provided. TI bases its knowledge and belief on information provided by third parties, and makes no representation or warranty as to the accuracy of such information. Efforts are underway to better integrate information from third parties. TI has taken and continues to take reasonable steps to provide representative and accurate information but may not have conducted destructive testing or chemical analysis on incoming materials and chemicals. TI and TI suppliers consider certain information to be proprietary, and thus CAS numbers and other limited information may not be available for release.

In no event shall TI's liability arising out of such information exceed the total purchase price of the TI part(s) at issue in this document sold by TI to Customer on an annual basis.

TAPE AND REEL INFORMATION

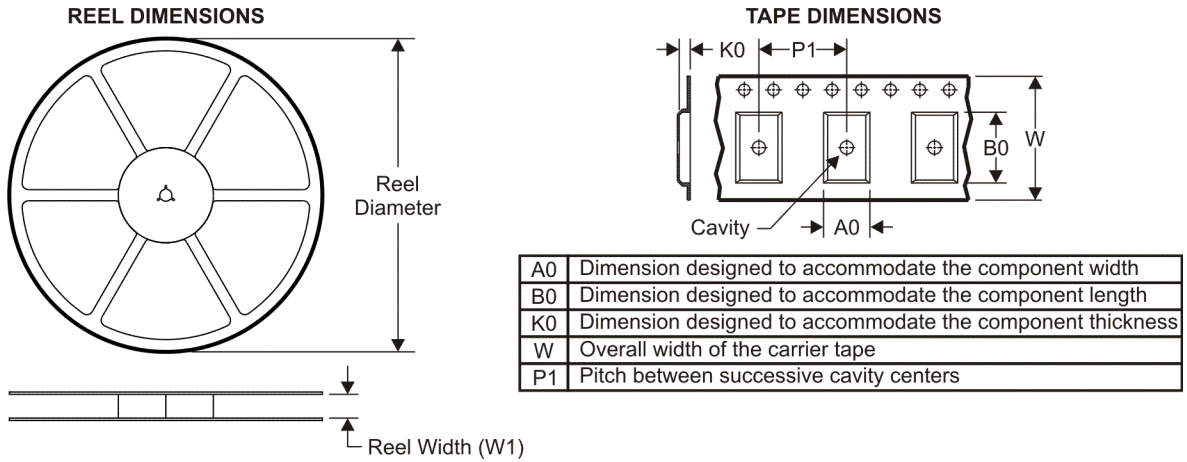

QUADRANT ASSIGNMENTS FOR PIN 1 ORIENTATION IN TAPE



*All dimensions are nominal

Device	Package Type	Package Drawing	Pins	SPQ	Reel Diameter (mm)	Reel Width W1 (mm)	A0 (mm)	B0 (mm)	K0 (mm)	P1 (mm)	W (mm)	Pin1 Quadrant
ADS5273IPFPT	HTQFP	PFP	80	250	330.0	24.4	15.0	15.0	1.5	20.0	24.0	Q2

TAPE AND REEL BOX DIMENSIONS



*All dimensions are nominal

Device	Package Type	Package Drawing	Pins	SPQ	Length (mm)	Width (mm)	Height (mm)
ADS5273IPFPT	HTQFP	PPF	80	250	346.0	346.0	41.0

PFP (S-PQFP-G80)

PowerPAD™ PLASTIC QUAD FLATPACK

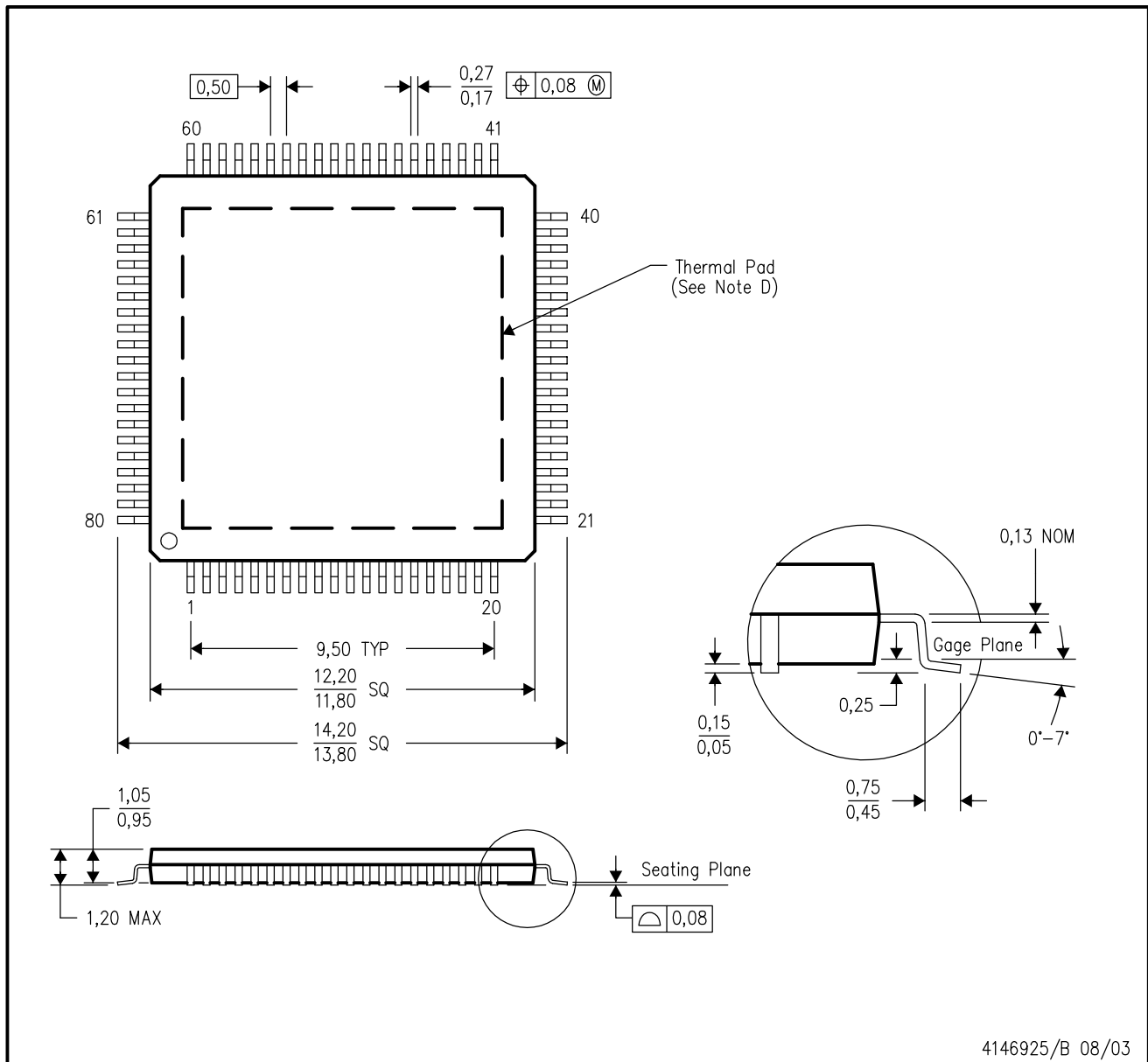

- NOTES:
- A. All linear dimensions are in millimeters.
 - B. This drawing is subject to change without notice.
 - C. Body dimensions do not include mold flash or protrusion
 - D. This package is designed to be soldered to a thermal pad on the board. Refer to Technical Brief, PowerPad Thermally Enhanced Package, Texas Instruments Literature No. SLMA002 for information regarding recommended board layout. This document is available at www.ti.com <<http://www.ti.com>>.
 - E. Falls within JEDEC MS-026

PowerPAD is a trademark of Texas Instruments.

THERMAL INFORMATION

This PowerPAD™ package incorporates an exposed thermal pad that is designed to be attached to a printed circuit board (PCB). The thermal pad must be soldered directly to the PCB. After soldering, the PCB can be used as a heatsink. In addition, through the use of thermal vias, the thermal pad can be attached directly to the appropriate copper plane shown in the electrical schematic for the device, or alternatively, can be attached to a special heatsink structure designed into the PCB. This design optimizes the heat transfer from the integrated circuit (IC).

For additional information on the PowerPAD package and how to take advantage of its heat dissipating abilities, refer to Technical Brief, PowerPAD Thermally Enhanced Package, Texas Instruments Literature No. SLMA002 and Application Brief, PowerPAD Made Easy, Texas Instruments Literature No. SLMA004. Both documents are available at www.ti.com.

The exposed thermal pad dimensions for this package are shown in the following illustration.

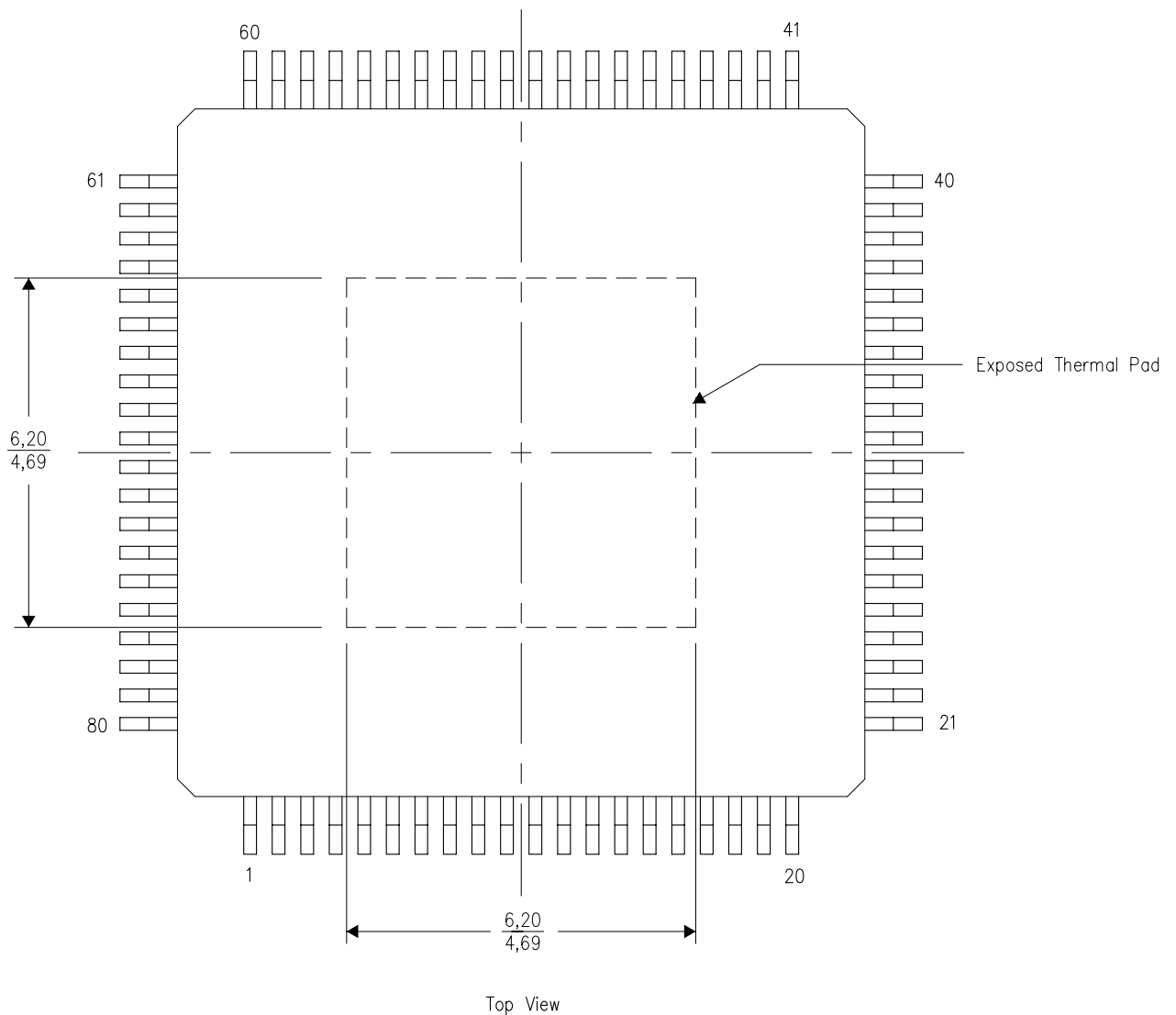

NOTE: All linear dimensions are in millimeters

PFP (S-PQFP-G80) PowerPAD™

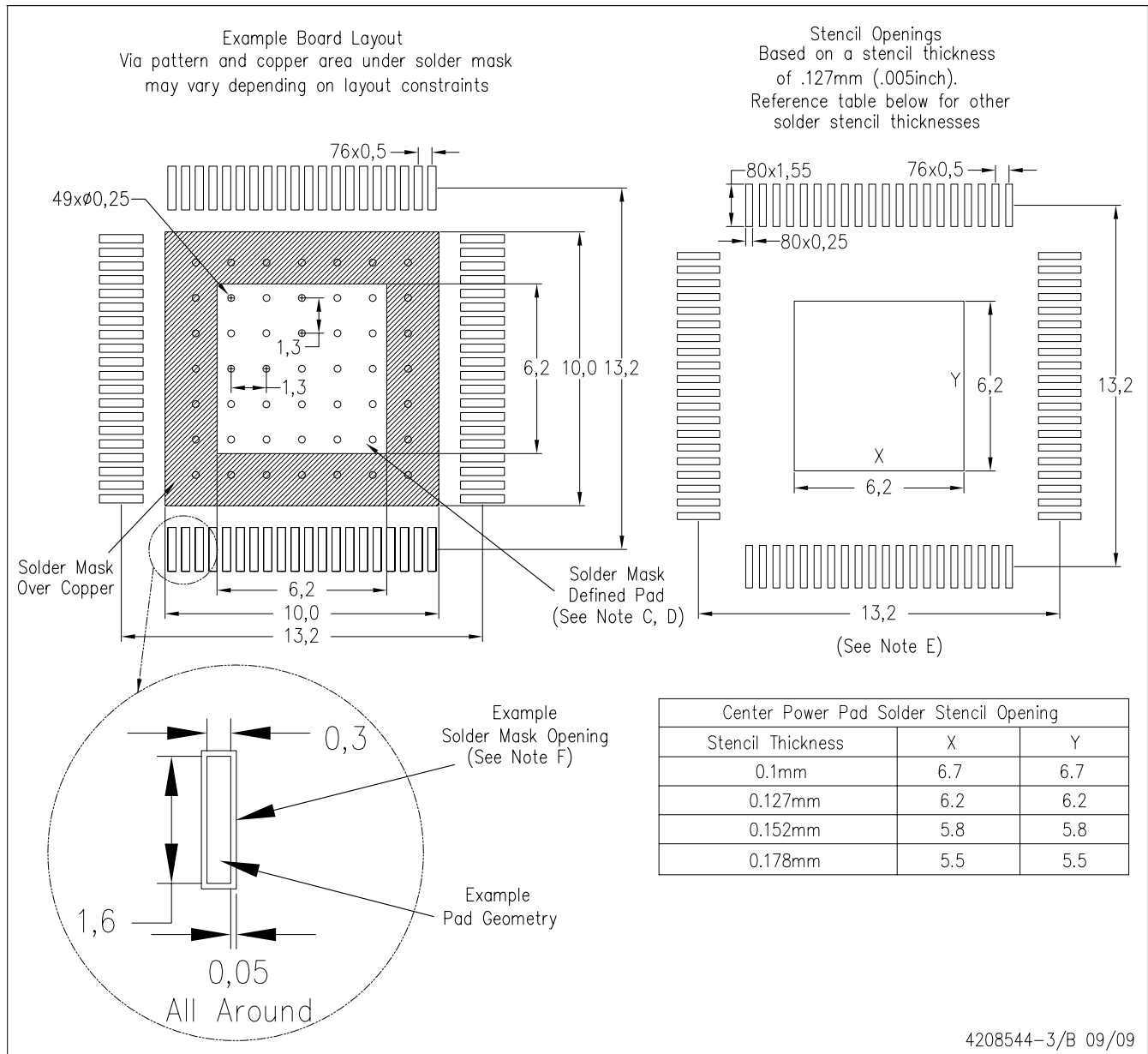

- NOTES:
- All linear dimensions are in millimeters.
 - This drawing is subject to change without notice.
 - Customers should place a note on the circuit board fabrication drawing not to alter the center solder mask defined pad.
 - This package is designed to be soldered to a thermal pad on the board. Refer to Technical Brief, PowerPAD Thermally Enhanced Package, Texas Instruments Literature No. SLMA002, SLMA004, and also the Product Data Sheets for specific thermal information, via requirements, and recommended board layout. These documents are available at www.ti.com <<http://www.ti.com>>. Publication IPC-7351 is recommended for alternate designs.
 - Laser cutting apertures with trapezoidal walls and also rounding corners will offer better paste release. Customers should contact their board assembly site for stencil design recommendations. Example stencil design based on a 50% volumetric metal load solder paste. Refer to IPC-7525 for other stencil recommendations.
 - Customers should contact their board fabrication site for solder mask tolerances between and around signal pads.

PowerPAD is a trademark of Texas Instruments.

IMPORTANT NOTICE

Texas Instruments Incorporated and its subsidiaries (TI) reserve the right to make corrections, modifications, enhancements, improvements, and other changes to its products and services at any time and to discontinue any product or service without notice. Customers should obtain the latest relevant information before placing orders and should verify that such information is current and complete. All products are sold subject to TI's terms and conditions of sale supplied at the time of order acknowledgment.

TI warrants performance of its hardware products to the specifications applicable at the time of sale in accordance with TI's standard warranty. Testing and other quality control techniques are used to the extent TI deems necessary to support this warranty. Except where mandated by government requirements, testing of all parameters of each product is not necessarily performed.

TI assumes no liability for applications assistance or customer product design. Customers are responsible for their products and applications using TI components. To minimize the risks associated with customer products and applications, customers should provide adequate design and operating safeguards.

TI does not warrant or represent that any license, either express or implied, is granted under any TI patent right, copyright, mask work right, or other TI intellectual property right relating to any combination, machine, or process in which TI products or services are used. Information published by TI regarding third-party products or services does not constitute a license from TI to use such products or services or a warranty or endorsement thereof. Use of such information may require a license from a third party under the patents or other intellectual property of the third party, or a license from TI under the patents or other intellectual property of TI.

Reproduction of TI information in TI data books or data sheets is permissible only if reproduction is without alteration and is accompanied by all associated warranties, conditions, limitations, and notices. Reproduction of this information with alteration is an unfair and deceptive business practice. TI is not responsible or liable for such altered documentation. Information of third parties may be subject to additional restrictions.

Resale of TI products or services with statements different from or beyond the parameters stated by TI for that product or service voids all express and any implied warranties for the associated TI product or service and is an unfair and deceptive business practice. TI is not responsible or liable for any such statements.

TI products are not authorized for use in safety-critical applications (such as life support) where a failure of the TI product would reasonably be expected to cause severe personal injury or death, unless officers of the parties have executed an agreement specifically governing such use. Buyers represent that they have all necessary expertise in the safety and regulatory ramifications of their applications, and acknowledge and agree that they are solely responsible for all legal, regulatory and safety-related requirements concerning their products and any use of TI products in such safety-critical applications, notwithstanding any applications-related information or support that may be provided by TI. Further, Buyers must fully indemnify TI and its representatives against any damages arising out of the use of TI products in such safety-critical applications.

TI products are neither designed nor intended for use in military/aerospace applications or environments unless the TI products are specifically designated by TI as military-grade or "enhanced plastic." Only products designated by TI as military-grade meet military specifications. Buyers acknowledge and agree that any such use of TI products which TI has not designated as military-grade is solely at the Buyer's risk, and that they are solely responsible for compliance with all legal and regulatory requirements in connection with such use.

TI products are neither designed nor intended for use in automotive applications or environments unless the specific TI products are designated by TI as compliant with ISO/TS 16949 requirements. Buyers acknowledge and agree that, if they use any non-designated products in automotive applications, TI will not be responsible for any failure to meet such requirements.

Following are URLs where you can obtain information on other Texas Instruments products and application solutions:

Products		Applications	
Amplifiers	amplifier.ti.com	Audio	www.ti.com/audio
Data Converters	dataconverter.ti.com	Automotive	www.ti.com/automotive
DLP® Products	www.dlp.com	Communications and Telecom	www.ti.com/communications
DSP	dsp.ti.com	Computers and Peripherals	www.ti.com/computers
Clocks and Timers	www.ti.com/clocks	Consumer Electronics	www.ti.com/consumer-apps
Interface	interface.ti.com	Energy	www.ti.com/energy
Logic	logic.ti.com	Industrial	www.ti.com/industrial
Power Mgmt	power.ti.com	Medical	www.ti.com/medical
Microcontrollers	microcontroller.ti.com	Security	www.ti.com/security
RFID	www.ti-rfid.com	Space, Avionics & Defense	www.ti.com/space-avionics-defense
RF/IF and ZigBee® Solutions	www.ti.com/lprf	Video and Imaging	www.ti.com/video
		Wireless	www.ti.com/wireless-apps

Mailing Address: Texas Instruments, Post Office Box 655303, Dallas, Texas 75265
Copyright © 2010, Texas Instruments Incorporated