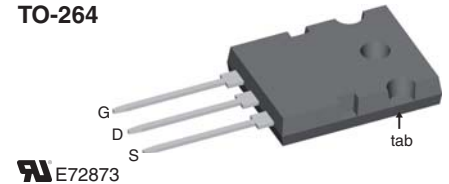

# CoolMOS™ 1) Power MOSFET

Low  $R_{DS(on)}$ , high  $V_{DSS}$   
Superjunction MOSFET

$V_{DSS} = 600\text{ V}$   
 $I_{D25} = 94\text{ A}$   
 $R_{DS(on) \text{ max}} = 36\text{ m}\Omega$

**TO-264**

MOSFET			
Symbol	Conditions	Maximum Ratings	
$V_{DSS}$	$T_{VJ} = 25^\circ\text{C}$	600	V
$V_{GS}$		$\pm 20$	V
$I_{D25}$	$T_C = 25^\circ\text{C}$	85	A
$I_{D100}$	$T_C = 100^\circ\text{C}$	55	A
$E_{AS}$	single pulse $I_D = 10\text{ A}; T_C = 25^\circ\text{C}$	1800	mJ
$E_{AR}$	repetitive $I_D = 20\text{ A}; T_C = 25^\circ\text{C}$	tbd	mJ
$dV/dt$	MOSFET $dV/dt$ ruggedness $V_{DS} = 0 \dots 480\text{ V}$	tbd	V/ns

**Features**

- 3<sup>rd</sup> generation CoolMOS™ 1) power MOSFET
- high blocking capability
- lowest resistance
- avalanche rated for unclamped inductive switching (UIS)
- low thermal resistance due to reduced chip thickness

**Applications**

- Switched mode power supplies (SMPS)
- Uninterruptible power supplies (UPS)
- Power factor correction (PFC)
- Welding
- Inductive heating

Symbol	Conditions	Characteristic Values			
		$(T_{VJ} = 25^\circ\text{C}, \text{ unless otherwise specified})$			
		min.	typ.	max.	
$R_{DS(on)}$	$V_{GS} = 10\text{ V}; I_D = I_{D100}$ ①		30	36	m $\Omega$
$V_{GS(th)}$	$V_{DS} = V_{GS}; I_D = 4\text{ mA}$	2		4	V
$I_{DSS}$	$V_{DS} = V_{DSS}; V_{GS} = 0\text{ V}$			50	$\mu\text{A}$
	$T_{VJ} = 25^\circ\text{C}$			400	$\mu\text{A}$
	$T_{VJ} = 125^\circ\text{C}$				
$I_{GSS}$	$V_{GS} = \pm 20\text{ V}; V_{DS} = 0\text{ V}$			$\pm 200$	nA
$C_{iss}$	} $V_{GS} = 0\text{ V}; V_{DS} = 100\text{ V}$ $f = 1\text{ MHz}$		tbd		pF
$C_{oss}$			tbd		
$Q_g$	} $V_{GS} = 0\text{ to }10\text{ V}; V_{DS} = 350\text{ V}; I_D = 40\text{ A}$		540	650	ns
$Q_{gs}$			60		ns
$Q_{gd}$			220		ns
$t_{d(on)}$	} $V_{GS} = 10\text{ V}; V_{DS} = 380\text{ V}$ $I_D = 60\text{ A}; R_G = 2.2\ \Omega$		20		ns
$t_r$			27		ns
$t_{d(off)}$			14		ns
$t_f$			10		ns
$R_{thJC}$			0.18		K/W

① Pulse test,  $t \leq 300\ \mu\text{s}$ , duty cycle  $d \leq 2\%$

1) CoolMOS™ is a trademark of Infineon Technologies AG.

### Source-Drain Diode

Symbol	Conditions	Characteristic Values		
		min.	typ.	max.
$I_S$	$V_{GS} = 0 V$			A
$V_{SD}$	$I_F = 40 A; V_{GS} = 0 V$			V
$t_{rr}$	$I_F = 40 A; -di_F/dt = 100 A/\mu s; V_R = 640 V$			ns
$Q_{RM}$				$\mu C$
$I_{RM}$				A

( $T_{VJ} = 25^\circ C$ , unless otherwise specified)

### Component

Symbol	Conditions	Maximum Ratings	
$T_{VJ}$	operating	-55...+150	$^\circ C$
$T_{stg}$		-55...+150	$^\circ C$
$M_d$	mounting torque	0.8 ... 1.2	Nm

Symbol	Conditions	Characteristic Values		
		min.	typ.	max.
$R_{thCH}$	with heatsink compound		tbd	K/W
Weight			10	g

### TO-264 Outline

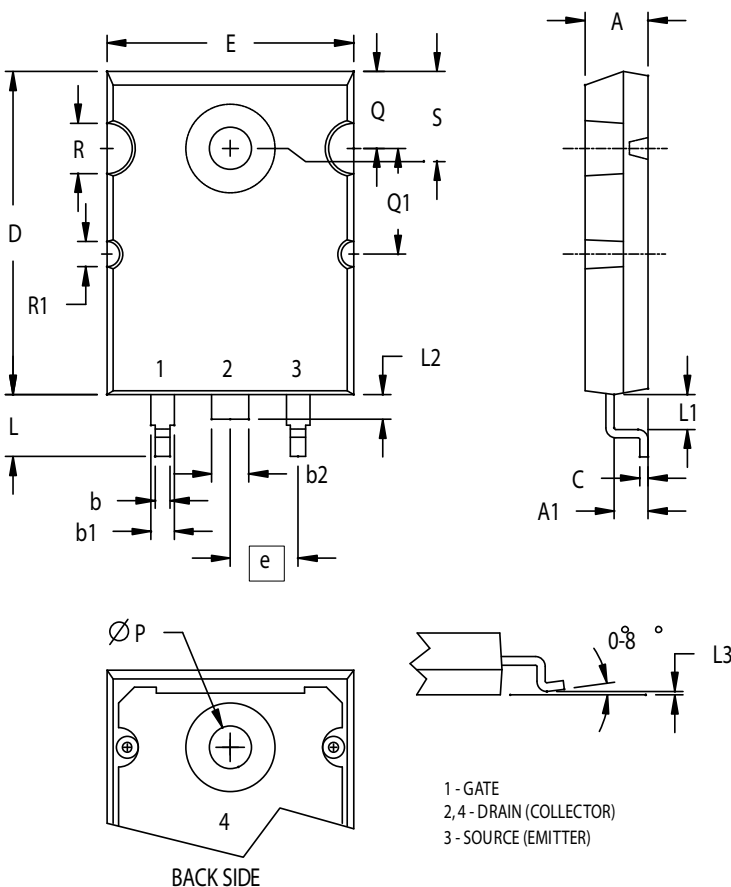

SYM	INCHES		MILLIMETERS	
	MIN	MAX	MIN	MAX
A	.185	.209	4.70	5.31
A1	.102	.118	2.59	3.00
b	.037	.055	0.94	1.40
b1	.087	.102	2.21	2.59
b2	.110	.126	2.79	3.20
C	.017	.029	0.43	0.74
D	1.007	1.047	25.58	26.59
E	.760	.799	19.30	20.29
e	.215 BSC		5.46 BSC	
L	.193	.201	4.90	5.10
L1	.088	.096	2.24	2.44
L2	.075	.083	1.90	2.10
L3	.000	.004	0.00	0.10
$\varnothing P$	.122	.138	3.10	3.51
Q	.240	.256	6.10	6.50
Q1	.330	.346	8.38	8.79
$\varnothing R$	.155	.187	3.94	4.75
$\varnothing R1$	.085	.093	2.16	2.36
S	.243	.253	6.17	6.43

NOTE: 1. This drawing meets all dimensions requirement of JEDEC outlines TO-264AA except L, L1, L2, L3.  
2. All metal surface are solder plated except trimmed area.

**Fig. 1. Output Characteristics @ 25 Deg. C**

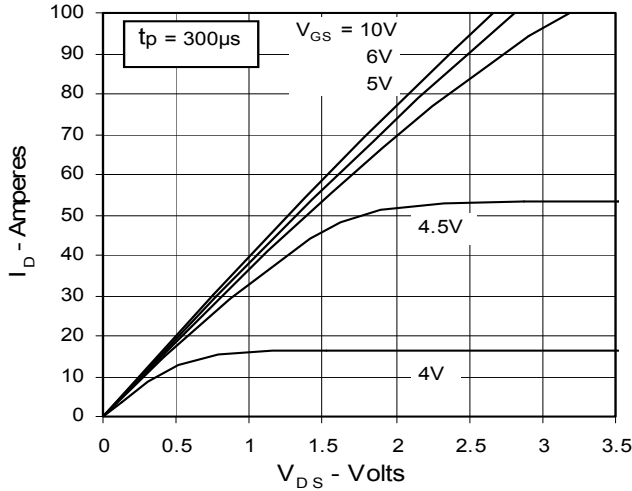

**Fig. 2. Extended Output Characteristics @ 25 deg. C**

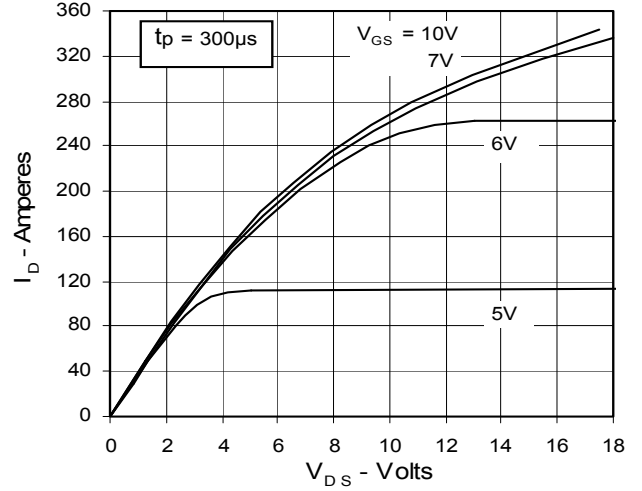

**Fig. 3. Output Characteristics @ 125 Deg. C**

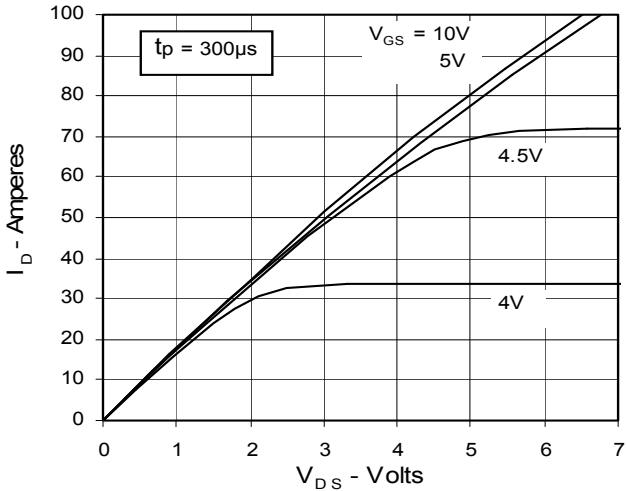

**Fig. 4. R\_DS(on) Normalized to I\_D100 Value vs. Junction Temperature**

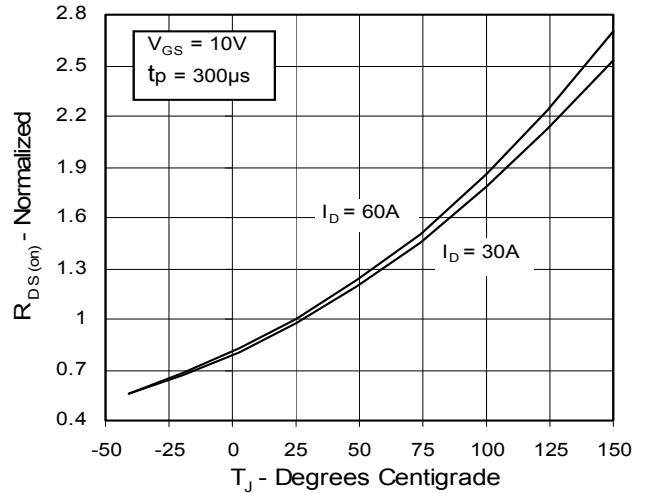

**Fig. 5. R\_DS(on) Normalized to I\_D100 Value vs. I\_D**

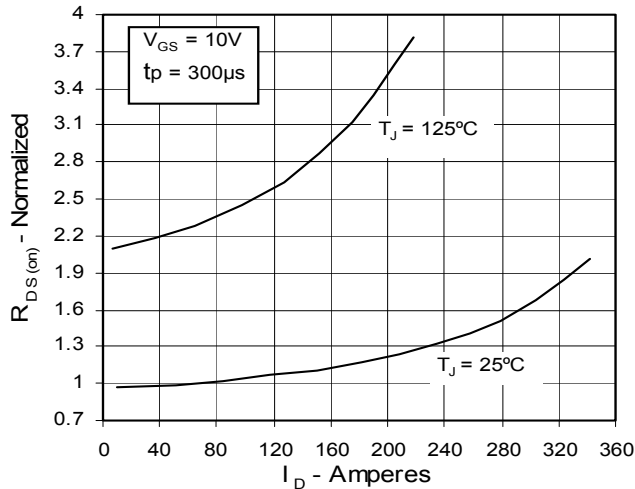

**Fig. 6. Drain Current vs. Case Temperature**

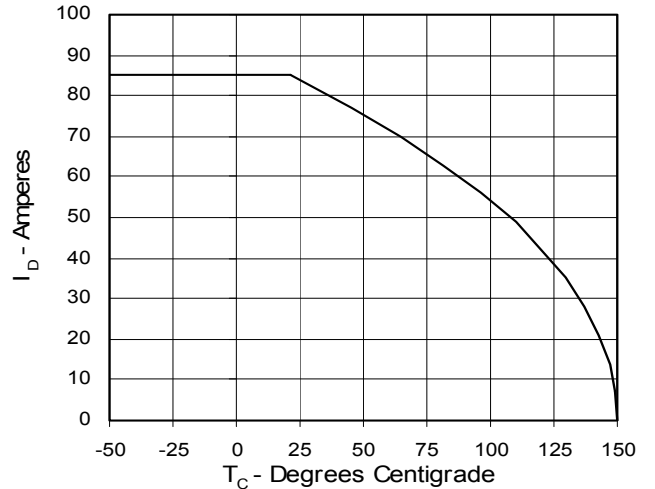

**Fig. 7. Input Admittance**

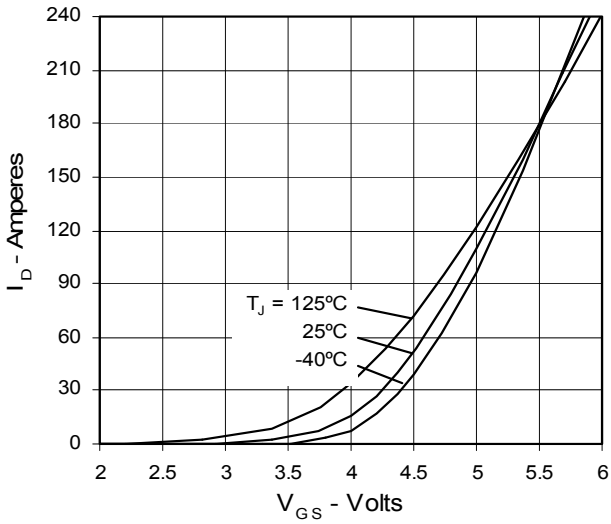

**Fig. 8. Transconductance**

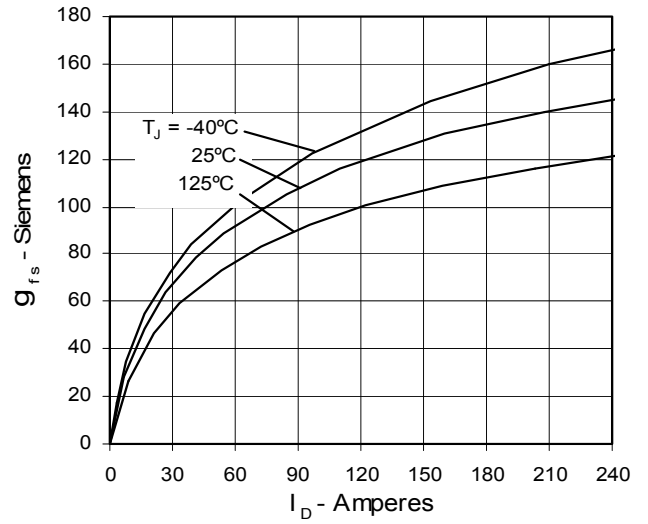

**Fig. 9. Source Current vs. Source-To-Drain Voltage**

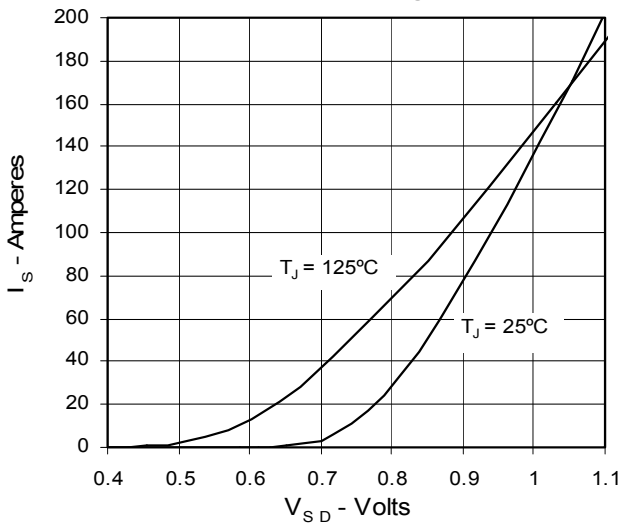

**Fig. 10. Gate Charge**

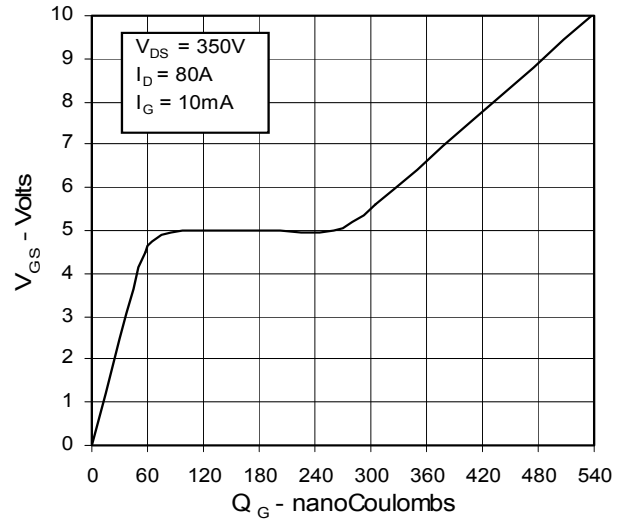

**Fig. 11. Capacitance**

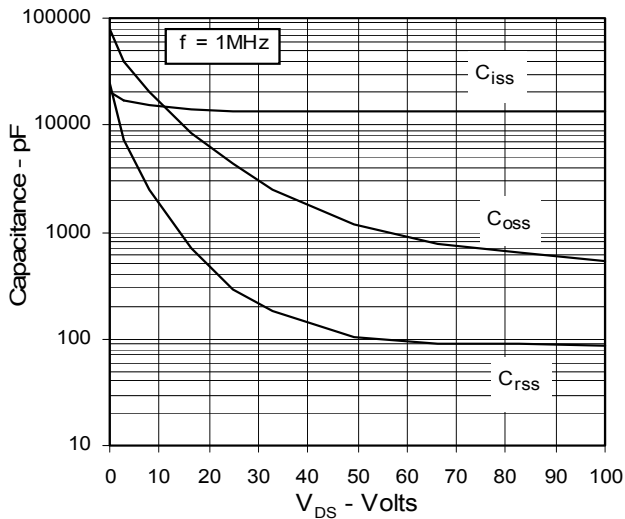

**Fig. 12. Maximum Transient Thermal Resistance**

