

IRF7907PbF

HEXFET[®] Power MOSFET

Applications

- Dual SO-8 MOSFET for POL Converters in Notebook Computers, Servers, Graphics Cards, Game Consoles and Set-Top Box

Benefits

- Very Low $R_{DS(on)}$ at 4.5V V_{GS}
- Low Gate Charge
- Fully Characterized Avalanche Voltage and Current
- 20V V_{GS} Max. Gate Rating
- Improved Body Diode Reverse Recovery
- 100% Tested for R_G
- Lead-Free

| V_{DSS} | $R_{DS(on)}$ max | I_D |
|-----------|------------------------------------|-------|
| 30V | Q1 16.4m Ω @ $V_{GS} = 10V$ | 9.1A |
| | Q2 11.8m Ω @ $V_{GS} = 10V$ | 11A |

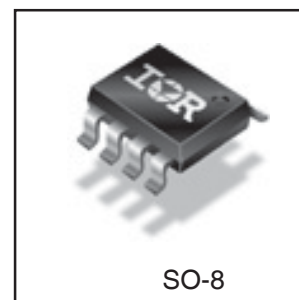
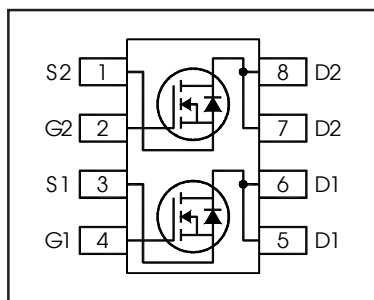

Absolute Maximum Ratings

| | Parameter | Q1 Max. | Q2 Max. | Units |
|--------------------------|--|--------------|---------|---------------|
| V_{DS} | Drain-to-Source Voltage | 30 | | V |
| V_{GS} | Gate-to-Source Voltage | ± 20 | | |
| $I_D @ T_A = 25^\circ C$ | Continuous Drain Current, $V_{GS} @ 10V$ | 9.1 | 11 | A |
| $I_D @ T_A = 70^\circ C$ | Continuous Drain Current, $V_{GS} @ 10V$ | 7.3 | 8.8 | |
| I_{DM} | Pulsed Drain Current ① | 76 | 85 | |
| $P_D @ T_A = 25^\circ C$ | Power Dissipation | 2.0 | 2.0 | W |
| $P_D @ T_A = 70^\circ C$ | Power Dissipation | 1.3 | 1.3 | |
| | Linear Derating Factor | 0.016 | 0.016 | W/ $^\circ C$ |
| T_J | Operating Junction and | -55 to + 150 | | $^\circ C$ |
| T_{STG} | Storage Temperature Range | | | |

Thermal Resistance

| | Parameter | Q1 Max. | Q2 Max. | Units |
|-----------------|--------------------------|---------|---------|--------------|
| $R_{\theta JL}$ | Junction-to-Drain Lead ⑤ | 20 | 20 | $^\circ C/W$ |
| $R_{\theta JA}$ | Junction-to-Ambient ④⑤ | 62.5 | 62.5 | |

IRF7907PbF

Static @ T_J = 25°C (unless otherwise specified)

International
IR Rectifier

| | Parameter | | Min. | Typ. | Max. | Units | Conditions | | |
|---------------------------------------|---|-------|------|-------|------|-------|--|----|---|
| BV _{DSS} | Drain-to-Source Breakdown Voltage | Q1&Q2 | 30 | — | — | V | V _{GS} = 0V, I _D = 250μA | | |
| ΔBV _{DSS} /ΔT _J | Breakdown Voltage Temp. Coefficient | Q1 | — | 0.024 | — | V/°C | Reference to 25°C, I _D = 1mA | | |
| | | Q2 | — | 0.024 | — | | | | |
| R _{DS(on)} | Static Drain-to-Source On-Resistance | Q1 | — | 13.7 | 16.4 | mΩ | V _{GS} = 10V, I _D = 9.1A ③ | | |
| | | | — | 17.1 | 20.5 | | V _{GS} = 4.5V, I _D = 7.3A ③ | | |
| | | Q2 | — | 9.8 | 11.8 | | V _{GS} = 10V, I _D = 11A ③ | | |
| | | | — | 11.5 | 13.7 | | V _{GS} = 4.5V, I _D = 8.8A ③ | | |
| V _{GS(th)} | Gate Threshold Voltage | Q1&Q2 | 1.35 | 1.8 | 2.35 | V | Q1: V _{DS} = V _{GS} , I _D = 25μA Q2: V _{DS} = V _{GS} , I _D = 50μA | | |
| ΔV _{GS(th)} /ΔT _J | Gate Threshold Voltage Coefficient | Q1 | — | -4.6 | — | mV/°C | | | |
| | | Q2 | — | -4.9 | — | | | | |
| I _{DSS} | Drain-to-Source Leakage Current | Q1&Q2 | — | — | 1.0 | μA | V _{DS} = 24V, V _{GS} = 0V | | |
| | | Q1&Q2 | — | — | 150 | | V _{DS} = 24V, V _{GS} = 0V, T _J = 125°C | | |
| I _{GSS} | Gate-to-Source Forward Leakage | Q1&Q2 | — | — | 100 | nA | V _{GS} = 20V | | |
| | Gate-to-Source Reverse Leakage | Q1&Q2 | — | — | -100 | | V _{GS} = -20V | | |
| g _{fs} | Forward Transconductance | Q1 | 19 | — | — | S | V _{DS} = 15V, I _D = 7.0A | | |
| | | Q2 | 24 | — | — | | V _{DS} = 15V, I _D = 8.8A | | |
| Q _g | Total Gate Charge | Q1 | — | 6.7 | 10 | nC | Q1 V _{DS} = 15V V _{GS} = 4.5V, I _D = 7.0A Q2 V _{DS} = 15V V _{GS} = 4.5V, I _D = 8.8A | | |
| | | Q2 | — | 14 | 21 | | | | |
| Q _{gs1} | Pre-V _{th} Gate-to-Source Charge | Q1 | — | 1.3 | — | | | | |
| | | Q2 | — | 3.0 | — | | | | |
| Q _{gs2} | Post-V _{th} Gate-to-Source Charge | Q1 | — | 0.7 | — | | | | |
| | | Q2 | — | 1.3 | — | | | | |
| Q _{gd} | Gate-to-Drain Charge | Q1 | — | 2.5 | — | | | | |
| | | Q2 | — | 4.9 | — | | | | |
| Q _{godr} | Gate Charge Overdrive | Q1 | — | 2.2 | — | | | | |
| | | Q2 | — | 4.8 | — | | | | |
| Q _{sw} | Switch Charge (Q _{gs2} + Q _{gd}) | Q1 | — | 3.2 | — | | | | |
| | | Q2 | — | 6.2 | — | | | | |
| Q _{oss} | Output Charge | Q1 | — | 4.5 | — | nC | V _{DS} = 16V, V _{GS} = 0V | | |
| | | Q2 | — | 9.0 | — | | | | |
| R _G | Gate Resistance | Q1 | — | 2.6 | 4.7 | Ω | | | |
| | | Q2 | — | 3.0 | 5.0 | | | | |
| t _{d(on)} | Turn-On Delay Time | Q1 | — | 6.0 | — | ns | Q1 V _{DD} = 15V, V _{GS} = 4.5V I _D = 7.0A Q2 V _{DD} = 15V, V _{GS} = 4.5V I _D = 8.8A Clamped Inductive Load | | |
| | | Q2 | — | 8.0 | — | | | | |
| t _r | Rise Time | Q1 | — | 9.3 | — | | | | |
| | | Q2 | — | 14 | — | | | | |
| t _{d(off)} | Turn-Off Delay Time | Q1 | — | 8.0 | — | | | | |
| | | Q2 | — | 13 | — | | | | |
| t _f | Fall Time | Q1 | — | 3.4 | — | | | | |
| | | Q2 | — | 5.3 | — | | | | |
| C _{iss} | Input Capacitance | Q1 | — | 850 | — | | | pF | V _{GS} = 0V V _{DS} = 15V f = 1.0MHz |
| | | Q2 | — | 1790 | — | | | | |
| C _{oss} | Output Capacitance | Q1 | — | 190 | — | | | | |
| | | Q2 | — | 390 | — | | | | |
| C _{rss} | Reverse Transfer Capacitance | Q1 | — | 88 | — | | | | |
| | | Q2 | — | 190 | — | | | | |

Avalanche Characteristics

| | Parameter | Typ. | Q1 Max. | Q2 Max. | Units |
|-----------------|---------------------------------|------|---------|---------|-------|
| E _{AS} | Single Pulse Avalanche Energy ② | — | 10 | 15 | mJ |
| I _{AR} | Avalanche Current ① | — | 7.0 | 8.8 | A |

Diode Characteristics

| | Parameter | | Min. | Typ. | Max. | Units | Conditions |
|-----------------|---|----|------|------|------|-------|--|
| I _S | Continuous Source Current (Body Diode) | Q1 | — | — | 2.8 | A | MOSFET symbol showing the integral reverse p-n junction diode. |
| | | Q2 | — | — | 2.8 | | |
| I _{SM} | Pulsed Source Current (Body Diode) ① | Q1 | — | — | 76 | A | |
| | | Q2 | — | — | 85 | | |
| V _{SD} | Diode Forward Voltage | Q1 | — | — | 1.0 | V | T _J = 25°C, I _S = 7.3A, V _{GS} = 0V ③ |
| | | Q2 | — | — | 1.0 | | T _J = 25°C, I _S = 8.8A, V _{GS} = 0V ③ |
| t _{rr} | Reverse Recovery Time | Q1 | — | 12 | 18 | ns | Q1 T _J = 25°C, I _F = 7.0A, V _{DD} = 15V, di/dt = 100A/μs ③ |
| | | Q2 | — | 16 | 24 | | |
| Q _{rr} | Reverse Recovery Charge | Q1 | — | 4.1 | 6.1 | nC | Q2 T _J = 25°C, I _F = 8.8A, V _{DD} = 15V, di/dt = 100A/μs ③ |
| | | Q2 | — | 5.9 | 8.9 | | |

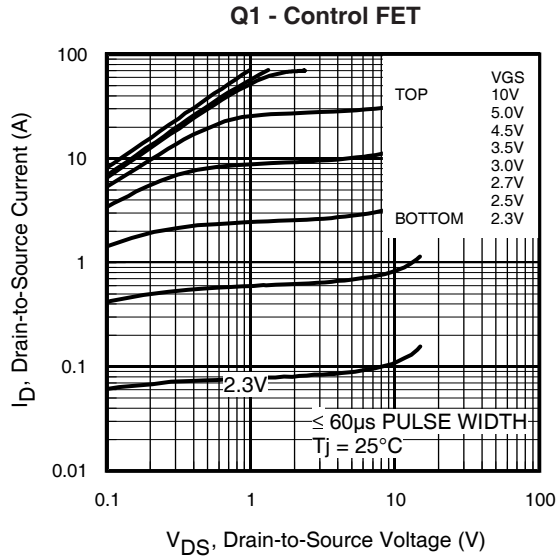

Fig 1. Typical Output Characteristics

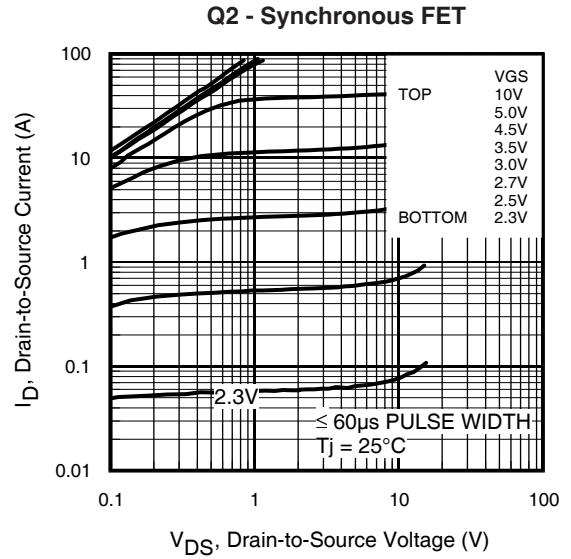

Fig 2. Typical Output Characteristics

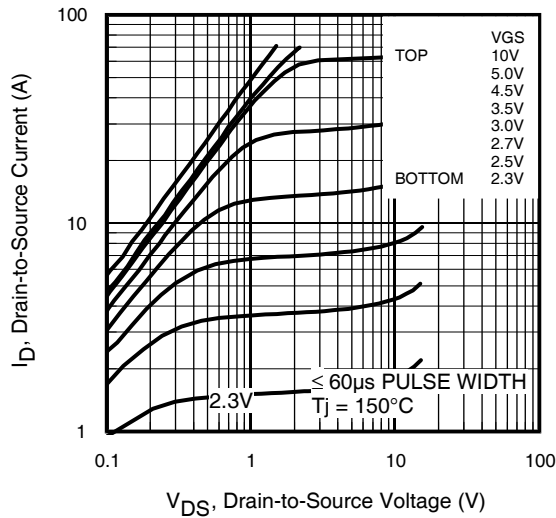

Fig 3. Typical Output Characteristics

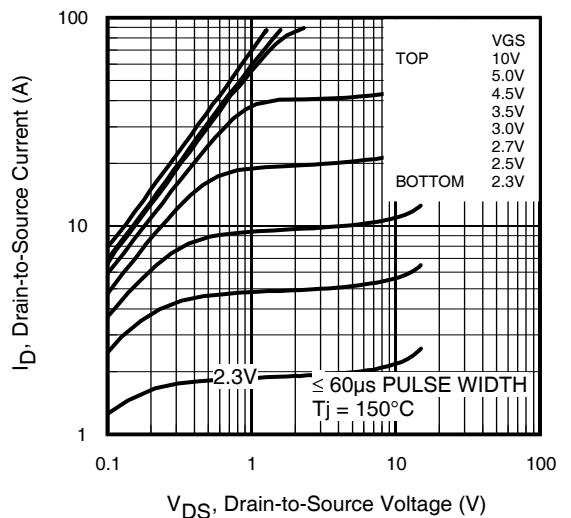

Fig 4. Typical Output Characteristics

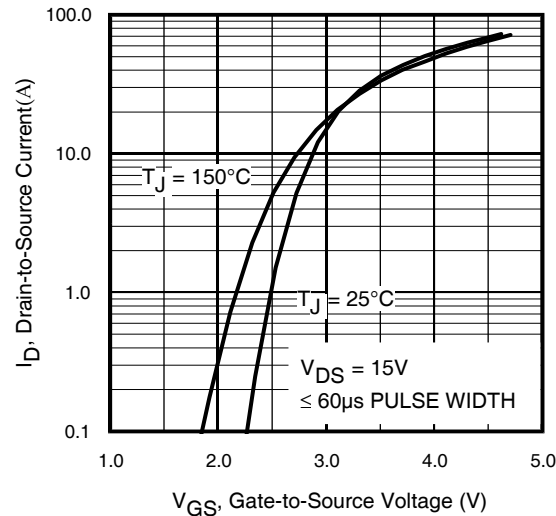

Fig 5. Typical Transfer Characteristics

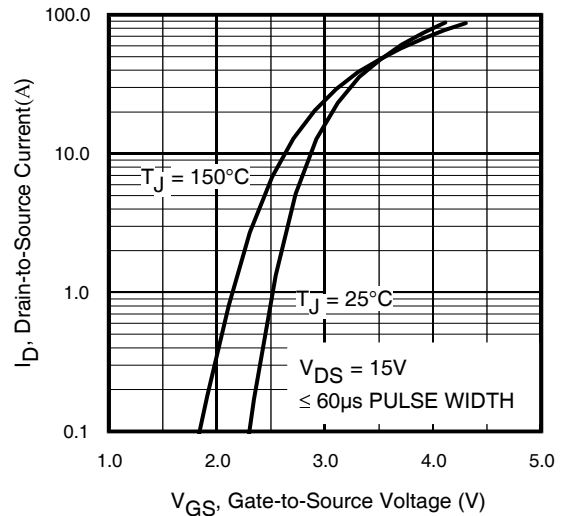

Fig 6. Typical Transfer Characteristics

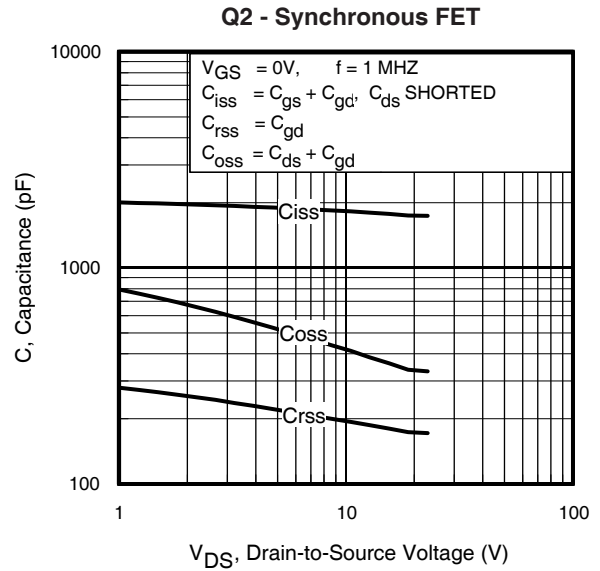
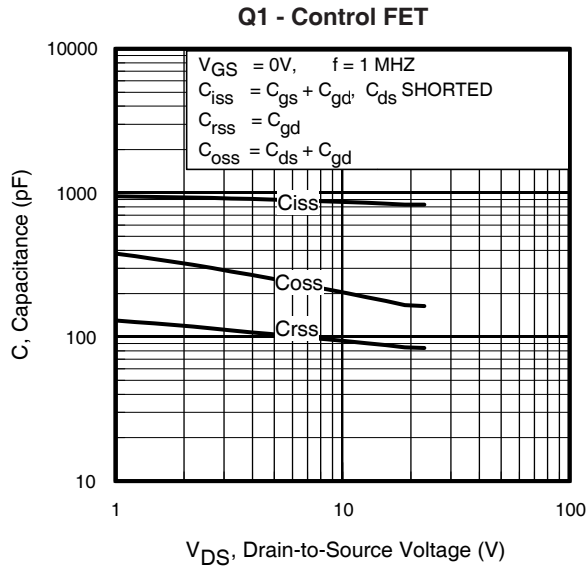

Fig 7. Typical Capacitance vs. Drain-to-Source Voltage **Fig 8.** Typical Capacitance vs. Drain-to-Source Voltage

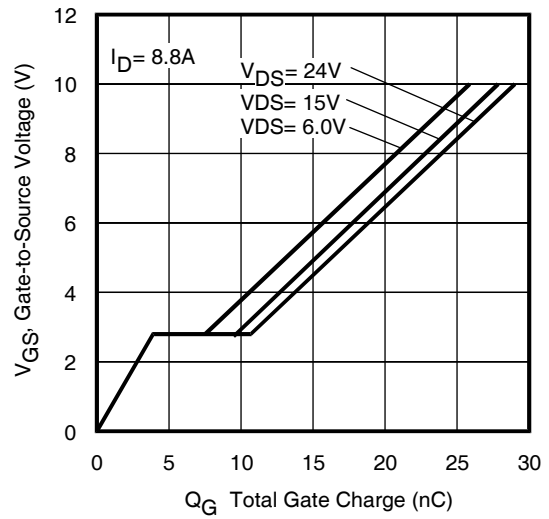
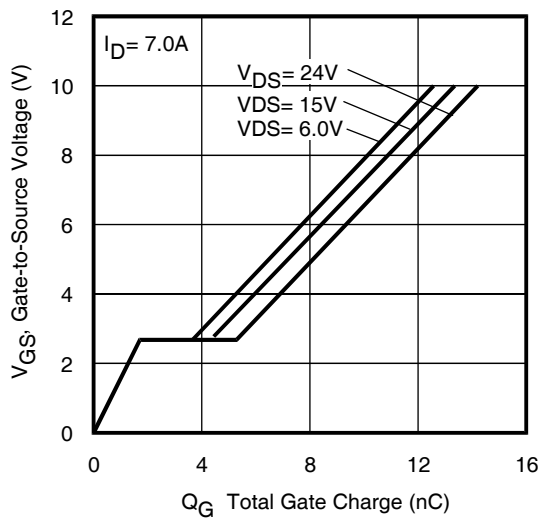

Fig 9. Typical Gate Charge vs. Gate-to-Source Voltage

Fig 10. Typical Gate Charge vs. Gate-to-Source Voltage

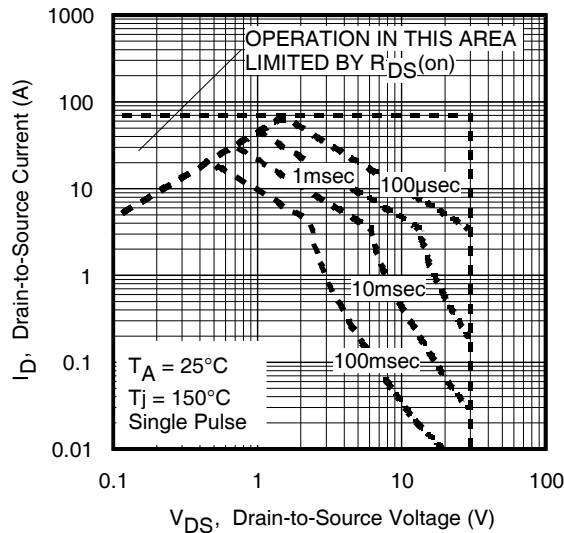

Fig 11. Maximum Safe Operating Area

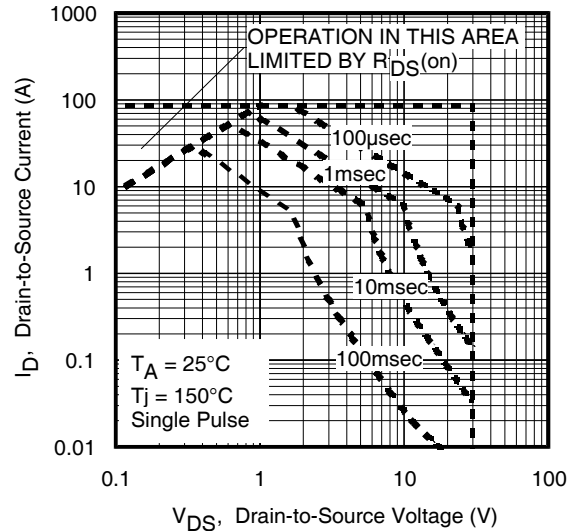

Fig 12. Maximum Safe Operating Area

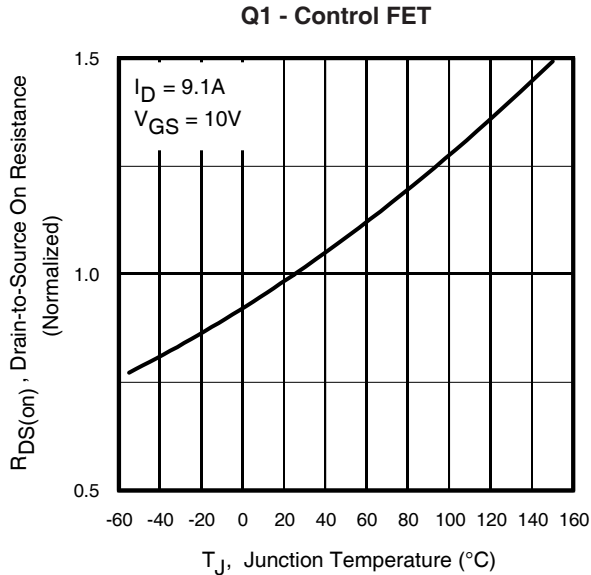

Fig 13. Normalized On-Resistance vs. Temperature

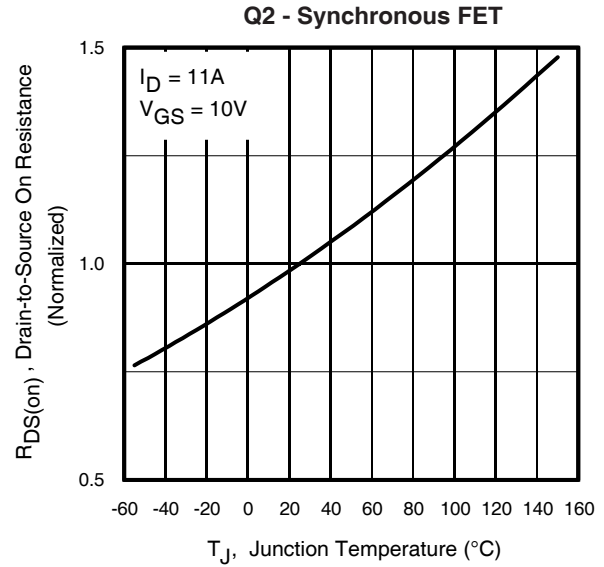

Fig 14. Normalized On-Resistance vs. Temperature

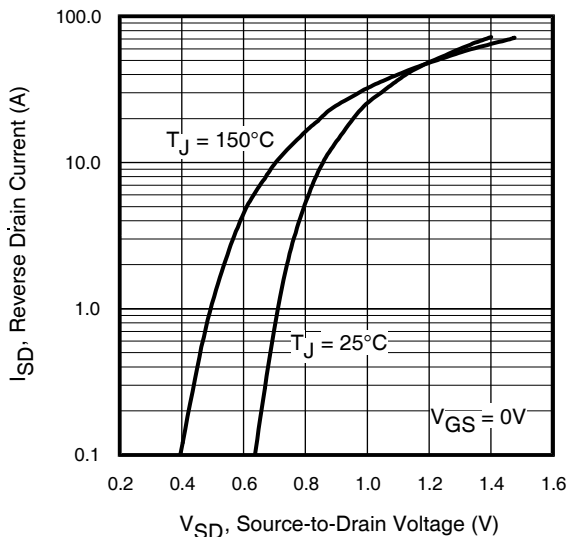

Fig 15. Typical Source-Drain Diode Forward Voltage

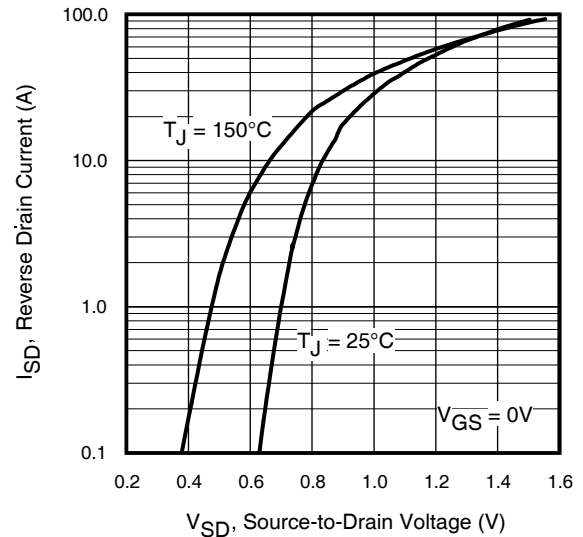

Fig 16. Typical Source-Drain Diode Forward Voltage

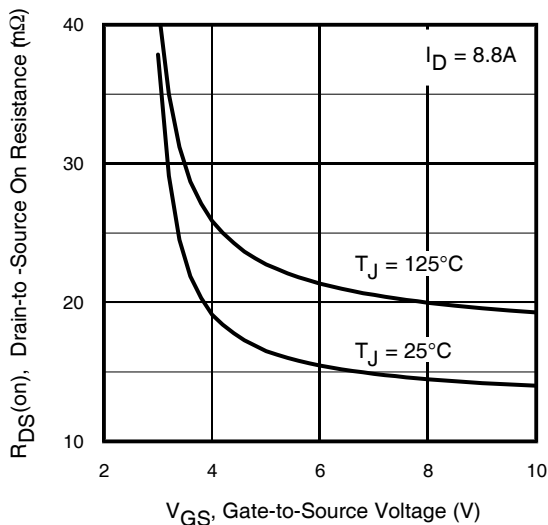

Fig 17. Typical On-Resistance vs. Gate Voltage

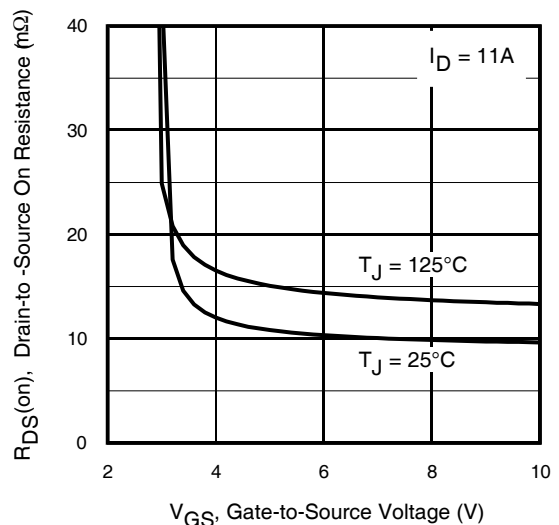

Fig 18. Typical On-Resistance vs. Gate Voltage

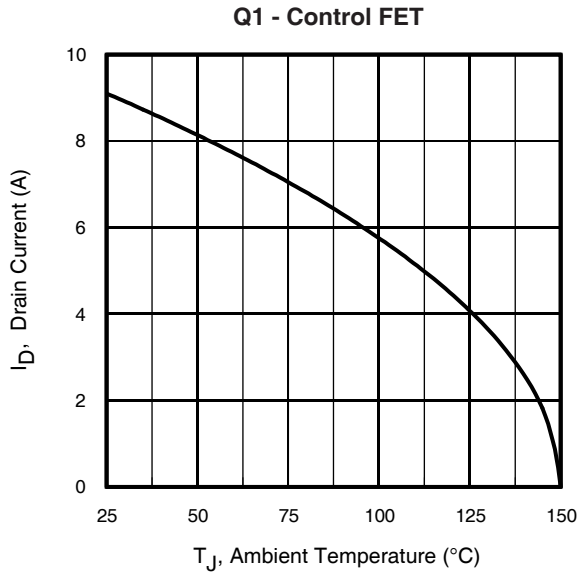

Fig 19. Maximum Drain Current vs. Ambient Temp.

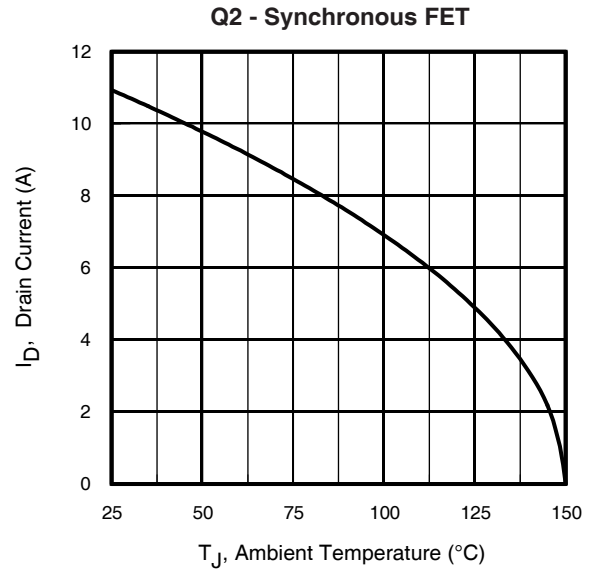

Fig 20. Maximum Drain Current vs. Ambient Temp.

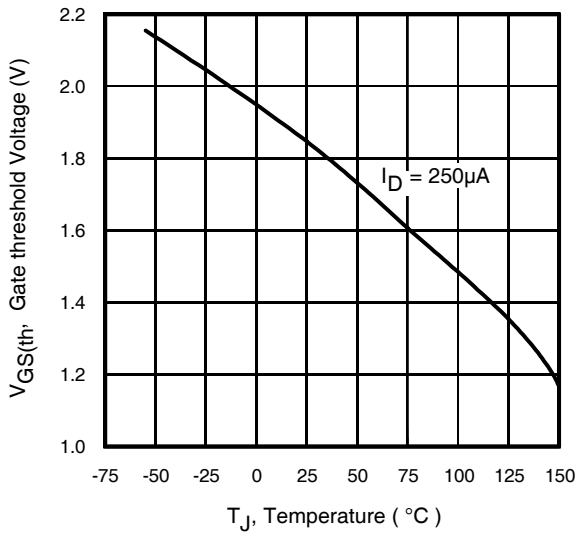

Fig 21. Threshold Voltage vs. Temperature

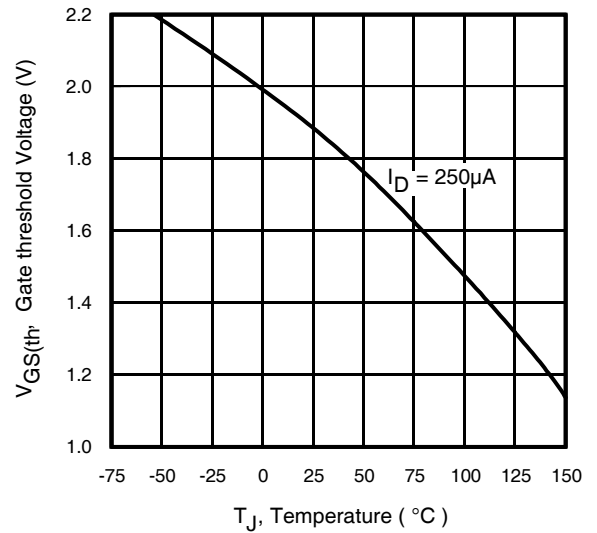

Fig 22. Threshold Voltage vs. Temperature

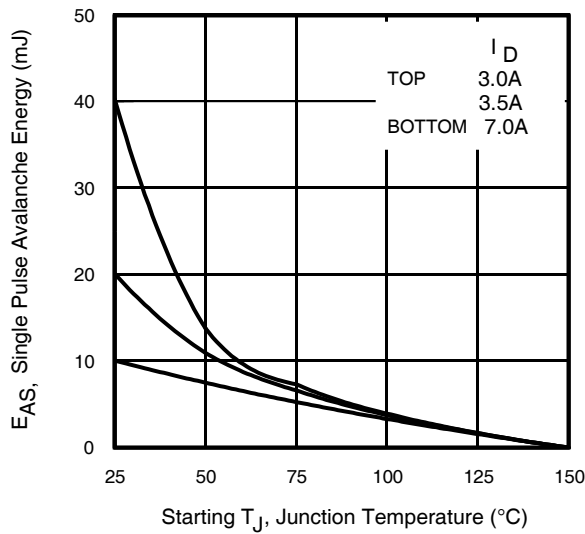

Fig 23. Maximum Avalanche Energy vs. Drain Current

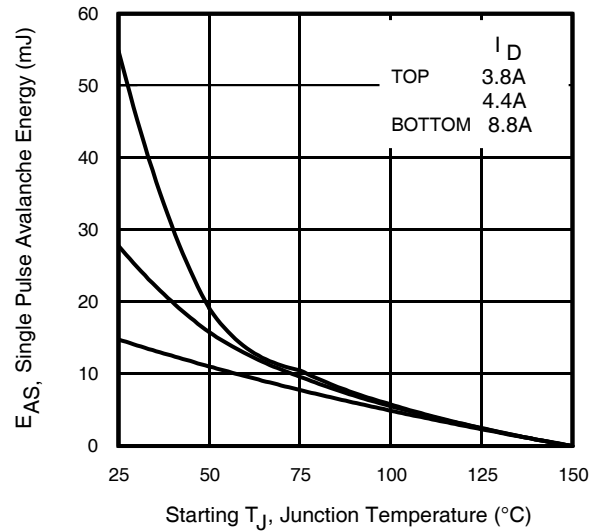

Fig 24. Maximum Avalanche Energy vs. Drain Current

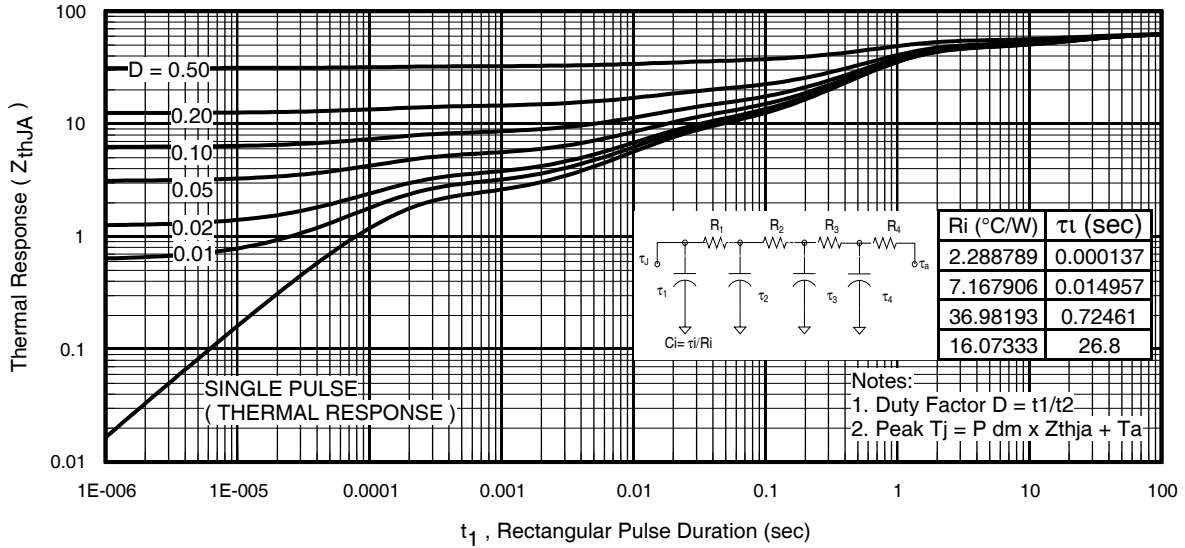

Fig 25. Maximum Effective Transient Thermal Impedance, Junction-to-Ambient (Q1)

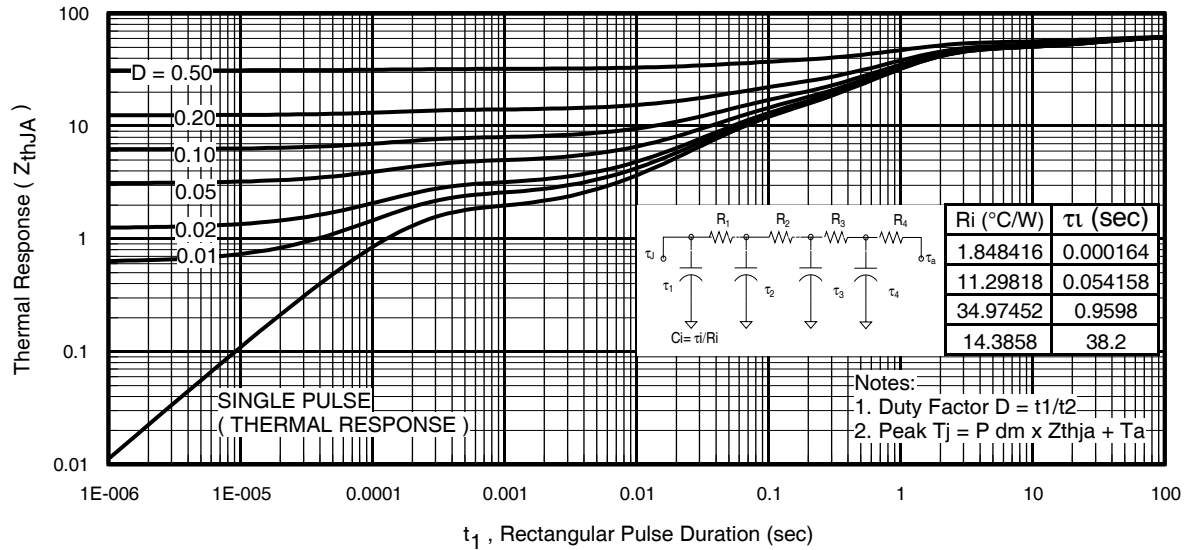

Fig 26. Maximum Effective Transient Thermal Impedance, Junction-to-Ambient (Q2)

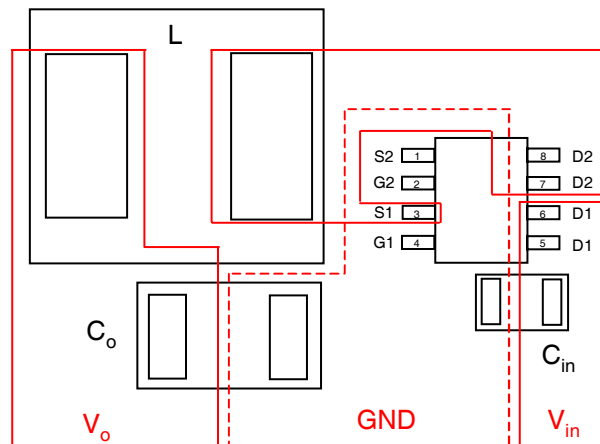

Fig 27. Layout Diagram

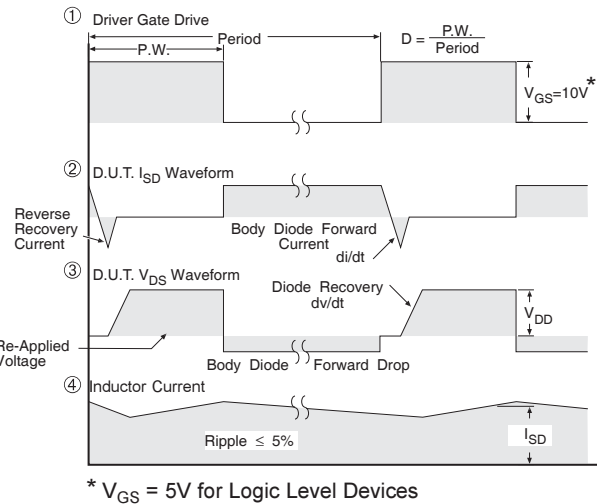
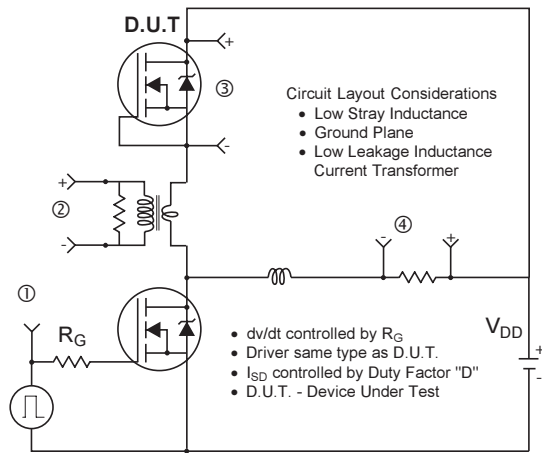

Fig 28. Peak Diode Recovery dv/dt Test Circuit for N-Channel HEXFET[®] Power MOSFETs

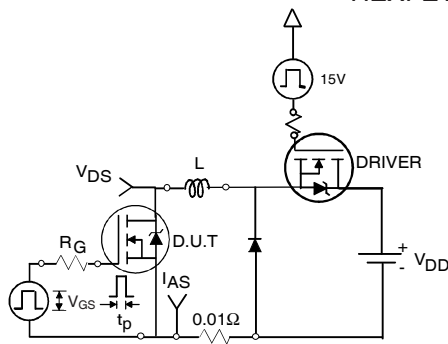

Fig 29a. Unclamped Inductive Test Circuit

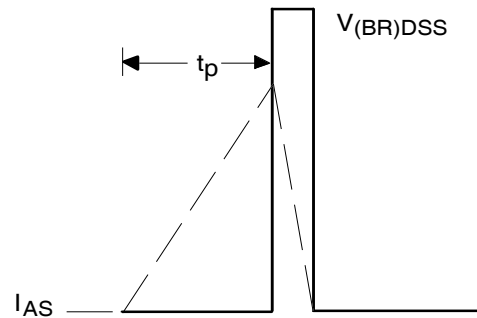

Fig 29b. Unclamped Inductive Waveforms

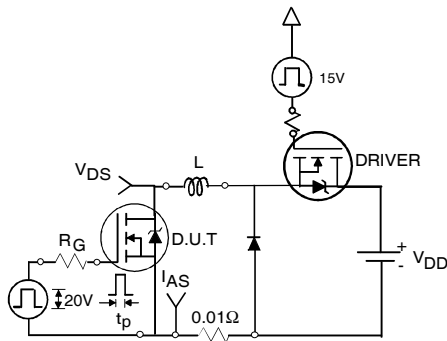

Fig 30a. Switching Time Test Circuit

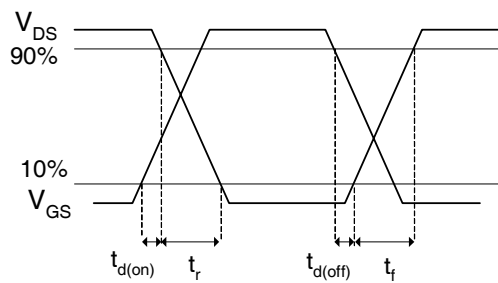

Fig 30b. Switching Time Waveforms

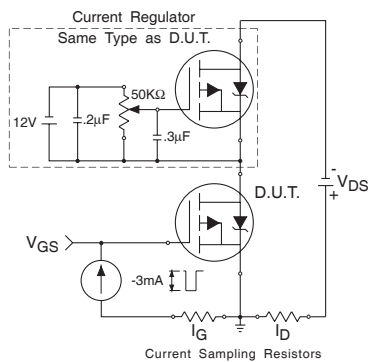

Fig 31a. Gate Charge Test Circuit

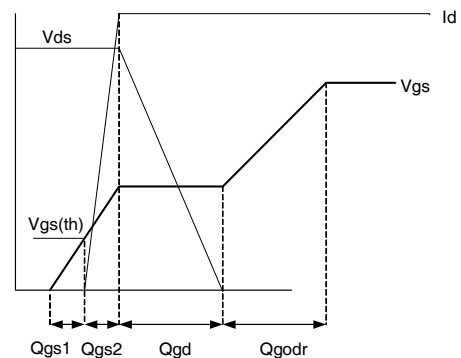
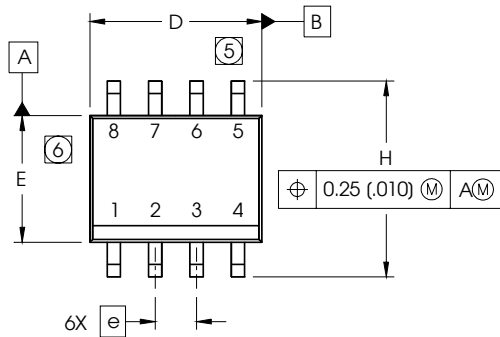
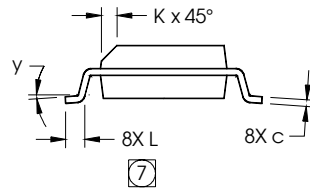
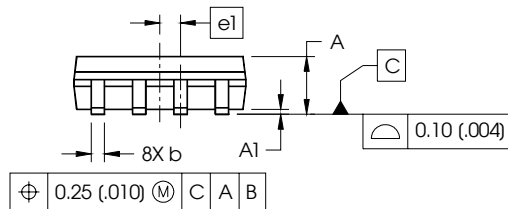

Fig 31b. Gate Charge Waveform

SO-8 Package Details



| DIM | INCHES | | MILLIMETERS | |
|-----|------------|-------|-------------|------|
| | MIN | MAX | MIN | MAX |
| A | .0532 | .0688 | 1.35 | 1.75 |
| A1 | .0040 | .0098 | 0.10 | 0.25 |
| b | .013 | .020 | 0.33 | 0.51 |
| c | .0075 | .0098 | 0.19 | 0.25 |
| D | .189 | .1968 | 4.80 | 5.00 |
| E | .1497 | .1574 | 3.80 | 4.00 |
| e | .050 BASIC | | 1.27 BASIC | |
| e1 | .025 BASIC | | 0.635 BASIC | |
| H | .2284 | .2440 | 5.80 | 6.20 |
| K | .0099 | .0196 | 0.25 | 0.50 |
| L | .016 | .050 | 0.40 | 1.27 |
| y | 0° | 8° | 0° | 8° |



NOTES:

1. DIMENSIONING & TOLERANCING PER ASME Y14.5M-1994.
2. CONTROLLING DIMENSION: MILLIMETER
3. DIMENSIONS ARE SHOWN IN MILLIMETERS (INCHES).
4. OUTLINE CONFORMS TO JEDEC OUTLINE MS-012AA.
- ⑤ DIMENSION DOES NOT INCLUDE MOLD PROTRUSIONS. MOLD PROTRUSIONS NOT TO EXCEED 0.15 (.006).
- ⑥ DIMENSION DOES NOT INCLUDE MOLD PROTRUSIONS. MOLD PROTRUSIONS NOT TO EXCEED 0.25 (.010).
- ⑦ DIMENSION IS THE LENGTH OF LEAD FOR SOLDERING TO A SUBSTRATE.

FOOTPRINT

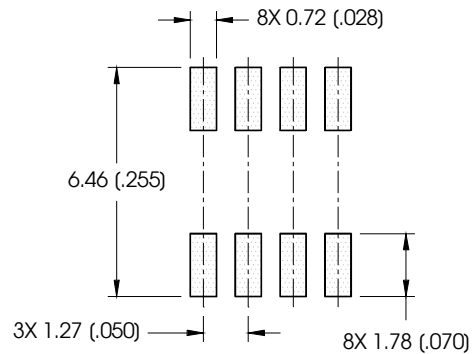

SO-8 Part Marking

EXAMPLE: THIS IS AN IRF7101 (MOSFET)

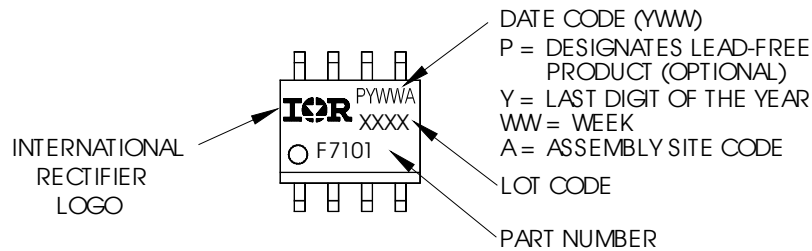

IRF7907PbF

SO-8 Tape and Reel

Dimensions are shown in millimeters (inches)

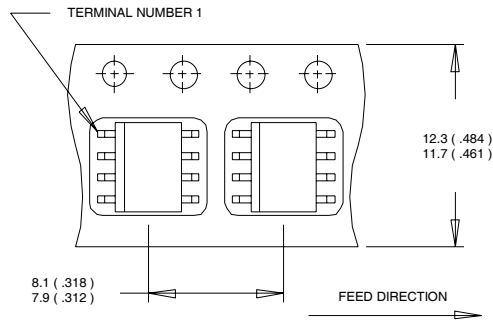

- NOTES:
1. CONTROLLING DIMENSION : MILLIMETER.
 2. ALL DIMENSIONS ARE SHOWN IN MILLIMETERS(INCHES).
 3. OUTLINE CONFORMS TO EIA-481 & EIA-541.

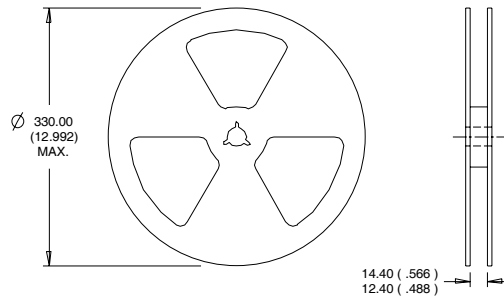

- NOTES :
1. CONTROLLING DIMENSION : MILLIMETER.
 2. OUTLINE CONFORMS TO EIA-481 & EIA-541.

Notes:

- ① Repetitive rating; pulse width limited by max. junction temperature.
- ② Starting $T_J = 25^\circ\text{C}$, Q1: $L = 0.41\text{mH}$, $R_G = 25\Omega$, $I_{AS} = 7.0\text{A}$;
Q2: $L = 0.38\text{mH}$, $R_G = 25\Omega$, $I_{AS} = 8.8\text{A}$.
- ③ Pulse width $\leq 400\mu\text{s}$; duty cycle $\leq 2\%$.
- ④ When mounted on 1 inch square copper board.
- ⑤ R_θ is measured at T_J approximately 90°C .

Data and specifications subject to change without notice.
This product has been designed and qualified for the Consumer market.
Qualification Standards can be found on IR's Web site.