

Features

- Dual N-Channel MOSFET
- Low On-Resistance
- Very Low Gate Threshold Voltage (1.0V max)
- Low Input Capacitance
- Fast Switching Speed
- Low Input/Output Leakage
- Small Surface Mount Package
- **Lead Free By Design/RoHS Compliant (Note 2)**
- **ESD Protected up to 2kV**
- **"Green" Device (Note 4)**
- **Qualified to AEC-Q101 standards for High Reliability**

Mechanical Data

- Case: SOT-26
- Case Material: Molded Plastic, "Green" Molding Compound. UL Flammability Classification Rating 94V-0
- Moisture Sensitivity: Level 1 per J-STD-020C
- Terminal Connections: See Diagram
- Terminals: Finish – Matte Tin annealed over Copper leadframe. Solderable per MIL-STD-202, Method 208
- Marking Information: See Page 4
- Ordering Information: See Page 4
- Weight: 0.015 grams (approximate)



TOP VIEW



BOTTOM VIEW

SOT-26

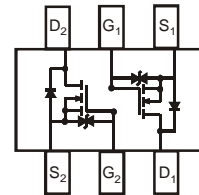
 TOP VIEW
Internal Schematic

Maximum Ratings @ $T_A = 25^\circ\text{C}$ unless otherwise specified

Characteristic	Symbol	Value	Unit
Drain Source Voltage	V_{DSS}	50	V
Gate-Source Voltage	V_{GSS}	± 20	V
Drain Current (Note 1)	I_D	Continuous	305
		Pulsed (Note 3)	800

Thermal Characteristics @ $T_A = 25^\circ\text{C}$ unless otherwise specified

Characteristic	Symbol	Value	Unit
Total Power Dissipation (Note 1)	P_D	400	mW
Thermal Resistance, Junction to Ambient	$R_{\theta JA}$	313	$^\circ\text{C/W}$
Operating and Storage Temperature Range	T_J, T_{STG}	-65 to +150	$^\circ\text{C}$

Electrical Characteristics @ $T_A = 25^\circ\text{C}$ unless otherwise specified

Characteristic	Symbol	Min	Typ	Max	Unit	Test Condition
OFF CHARACTERISTICS (Note 5)						
Drain-Source Breakdown Voltage	BV_{DSS}	50	—	—	V	$V_{GS} = 0V, I_D = 10\mu\text{A}$
Zero Gate Voltage Drain Current @ $T_C = 25^\circ\text{C}$	I_{DSS}	—	—	60	nA	$V_{DS} = 50V, V_{GS} = 0V$
Gate-Body Leakage	I_{GSS}	—	—	1	μA	$V_{GS} = \pm 12V, V_{DS} = 0V$
				500	nA	$V_{GS} = \pm 10V, V_{DS} = 0V$
50	nA	$V_{GS} = \pm 5V, V_{DS} = 0V$				
ON CHARACTERISTICS (Note 5)						
Gate Threshold Voltage	$V_{GS(th)}$	0.49	—	1.0	V	$V_{DS} = V_{GS}, I_D = 250\mu\text{A}$
Static Drain-Source On-Resistance	$R_{DS(ON)}$	—	—	3.0	Ω	$V_{GS} = 1.8V, I_D = 50\text{mA}$
				2.5	Ω	$V_{GS} = 2.5V, I_D = 50\text{mA}$
				2.0	Ω	$V_{GS} = 5.0V, I_D = 50\text{mA}$
On-State Drain Current	$I_{D(ON)}$	0.5	1.4	—	A	$V_{GS} = 10V, V_{DS} = 7.5V$
Forward Transconductance	$ Y_{fs} $	200	—	—	mS	$V_{DS} = 10V, I_D = 0.2A$
Source-Drain Diode Forward Voltage	V_{SD}	0.5	—	1.4	V	$V_{GS} = 0V, I_S = 115\text{mA}$
DYNAMIC CHARACTERISTICS						
Input Capacitance	C_{iss}	—	—	50	pF	$V_{DS} = 25V, V_{GS} = 0V$ $f = 1.0\text{MHz}$
Output Capacitance	C_{oss}	—	—	25	pF	
Reverse Transfer Capacitance	C_{rss}	—	—	5.0	pF	

- Notes:
1. Device mounted on FR-4 PCB.
 2. No purposefully added lead.
 3. Pulse width $\leq 10\mu\text{s}$, Duty Cycle $\leq 1\%$.
 4. Diodes Inc.'s "Green" policy can be found on our website at http://www.diodes.com/products/lead_free/index.php.
 5. Short duration pulse test used to minimize self-heating effect.

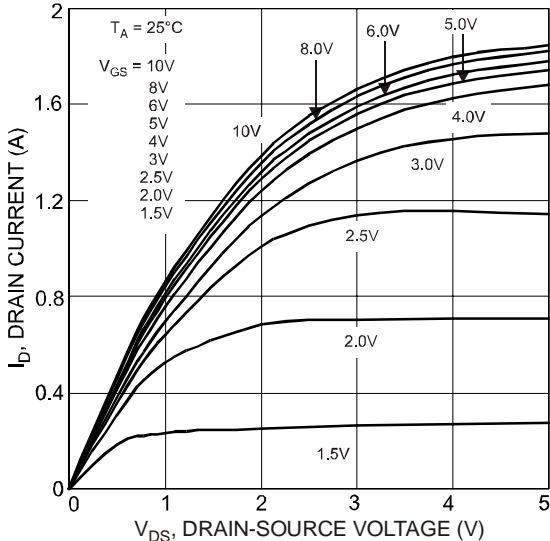

Fig. 1 Typical Output Characteristics

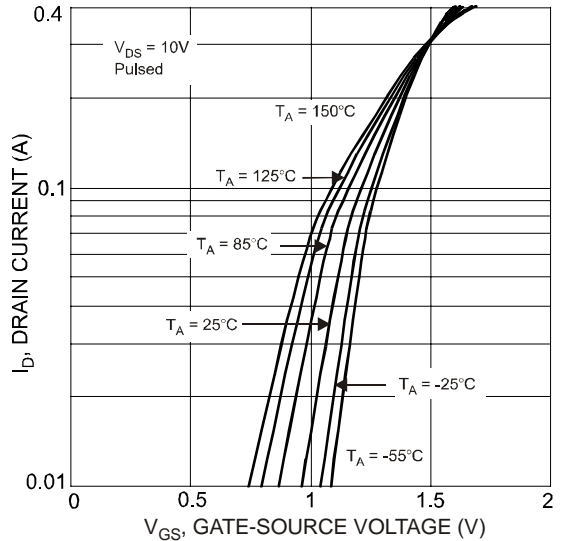

Fig. 2 Typical Transfer Characteristics

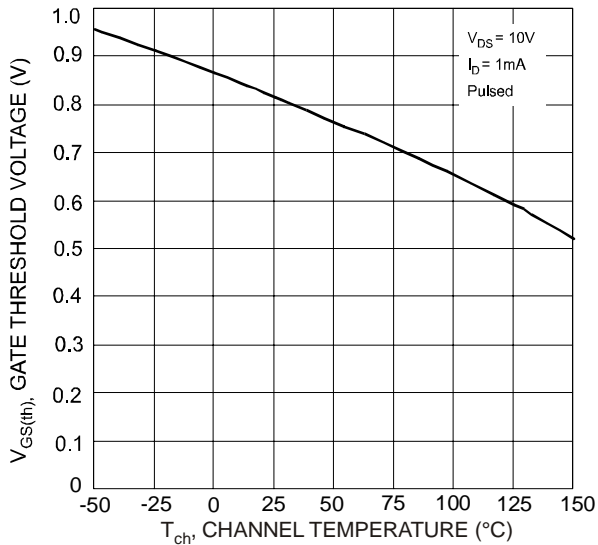

Fig. 3 Gate Threshold Voltage vs. Channel Temperature

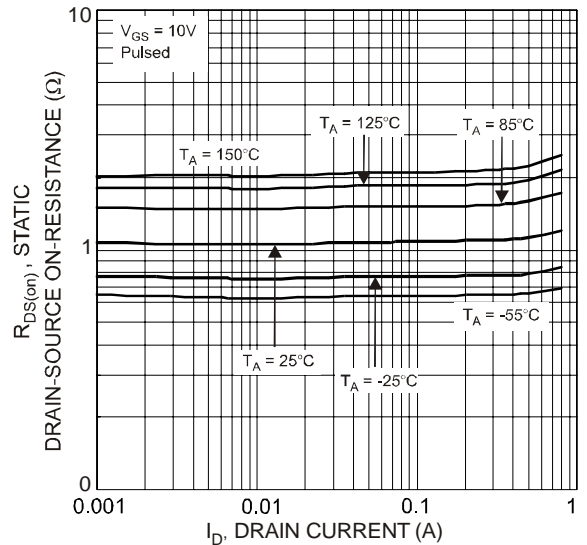

Fig. 4 Static Drain-Source On-Resistance vs. Drain Current

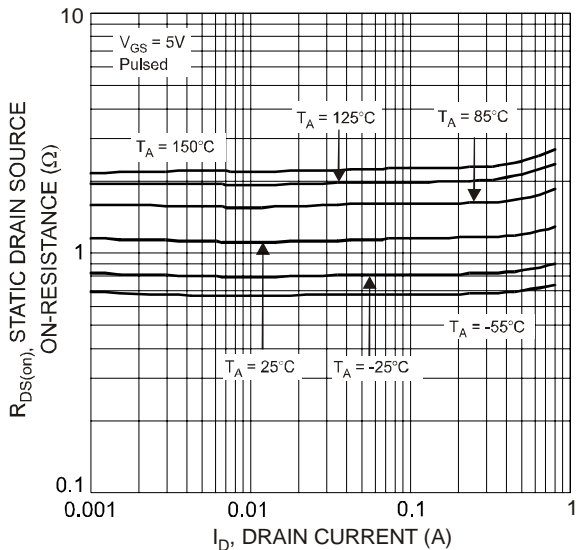

Fig. 5 Static Drain-Source On-Resistance vs. Drain Current

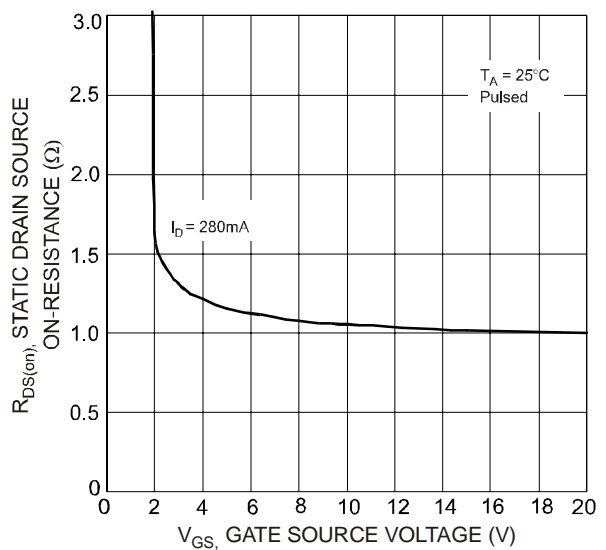

Fig. 6 Static Drain-Source On-Resistance vs. Gate-Source Voltage

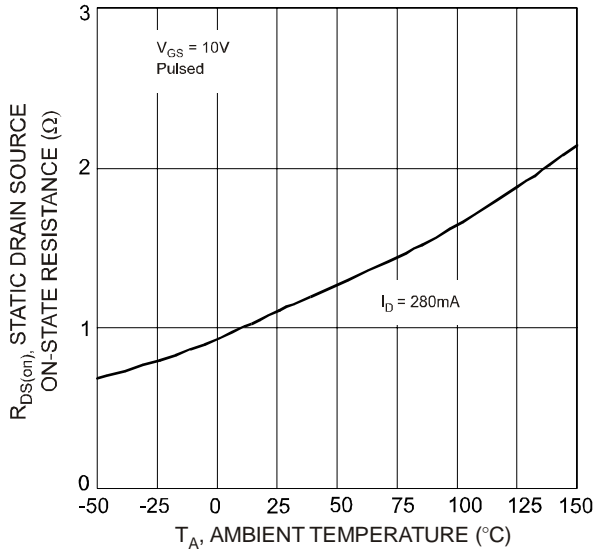

Fig. 7 Static Drain-Source On-State Resistance vs. Ambient Temperature

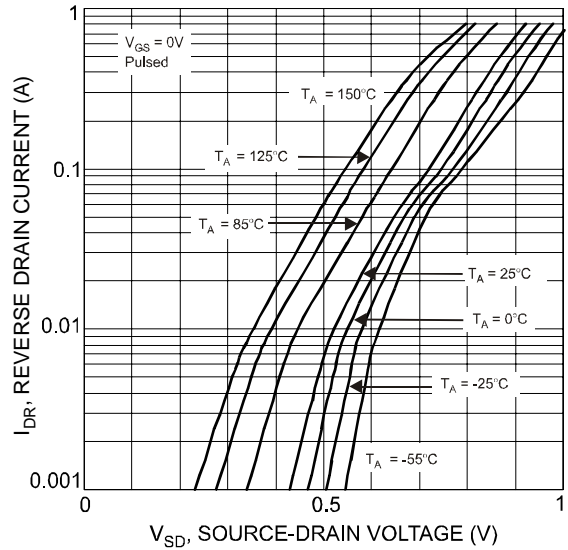

Fig. 8 Reverse Drain Current vs. Source-Drain Voltage

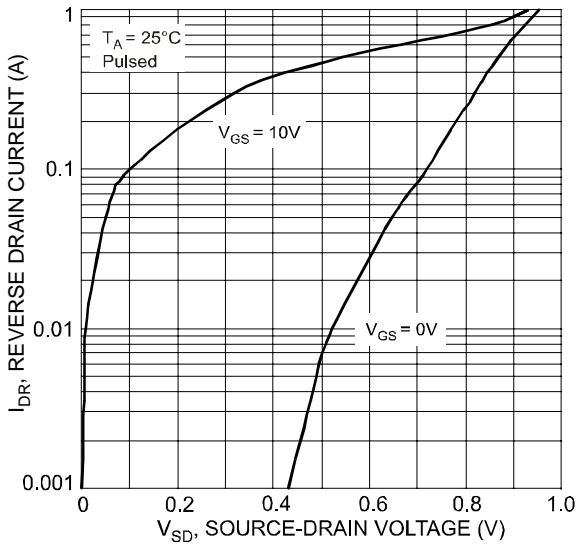

Fig. 9 Reverse Drain Current vs. Source-Drain Voltage

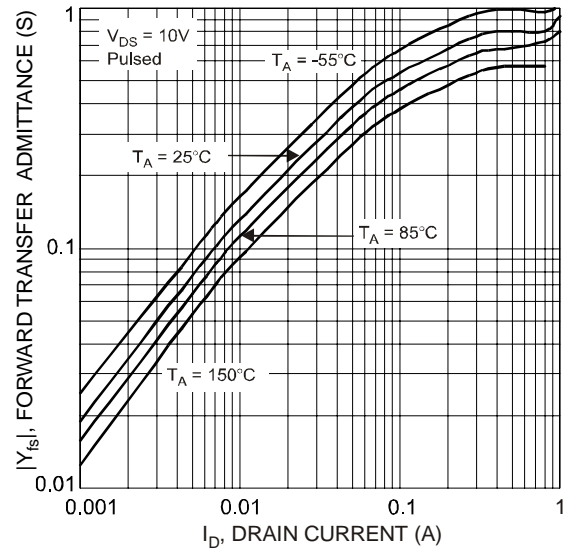

Fig. 10 Forward Transfer Admittance vs. Drain Current

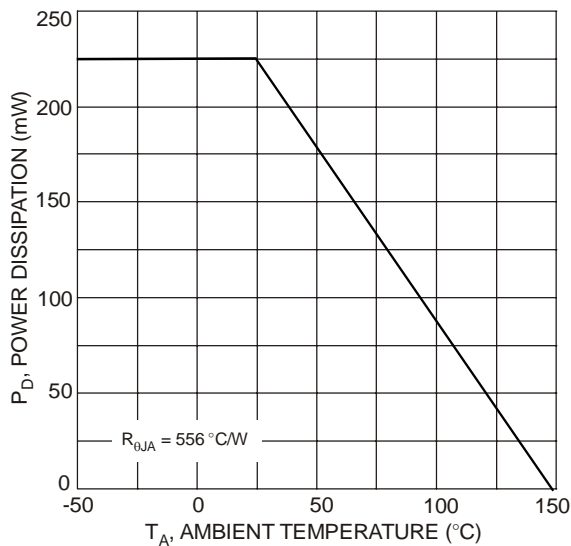

Fig. 11 Derating Curve - Total

Ordering Information (Note 6)

Part Number	Case	Packaging
DMN5L06DMK-7	SOT-26	3000/Tape & Reel

Notes: 6. For packaging details, go to our website at <http://www.diodes.com/datasheets/ap02007.pdf>.

Marking Information

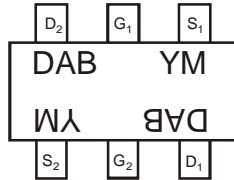

DAB = Marking Code
YM = Date Code Marking
Y = Year ex: T = 2006
M = Month ex: 9 = September

Date Code Key

Year	2006	2007	2008	2009	2010	2011	2012
Code	T	U	V	W	X	Y	Z

Month	Jan	Feb	Mar	Apr	May	Jun	Jul	Aug	Sep	Oct	Nov	Dec
Code	1	2	3	4	5	6	7	8	9	O	N	D

Package Outline Dimensions

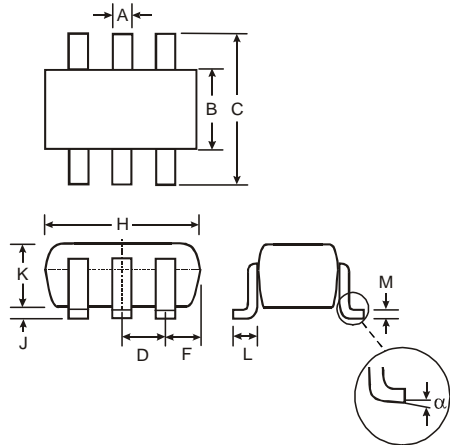

SOT-26			
Dim	Min	Max	Typ
A	0.35	0.50	0.38
B	1.50	1.70	1.60
C	2.70	3.00	2.80
D	-	-	0.95
F	-	-	0.55
H	2.90	3.10	3.00
J	0.013	0.10	0.05
K	1.00	1.30	1.10
L	0.35	0.55	0.40
M	0.10	0.20	0.15
α	0°	8°	-

All Dimensions in mm

Suggested Pad Layout

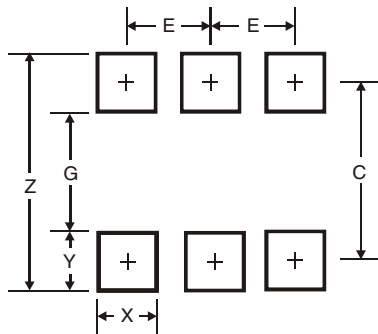

Dimensions	Value (in mm)
Z	3.20
G	1.60
X	0.55
Y	0.80
C	2.40
E	0.95

IMPORTANT NOTICE

Diodes Incorporated and its subsidiaries reserve the right to make modifications, enhancements, improvements, corrections or other changes without further notice to any product herein. Diodes Incorporated does not assume any liability arising out of the application or use of any product described herein; neither does it convey any license under its patent rights, nor the rights of others. The user of products in such applications shall assume all risks of such use and will agree to hold Diodes Incorporated and all the companies whose products are represented on our website, harmless against all damages.

LIFE SUPPORT

Diodes Incorporated products are not authorized for use as critical components in life support devices or systems without the expressed written approval of the President of Diodes Incorporated.