

PRODUCT SPECIFICATION

RoHS Compliance

DATE : 02/12/2008

cosmo ELECTRONICS CORPORATION	SOLID STATE RELAY - MOSFET OUTPUT KAQY217H	NO.60M00016	REV. 2
		SHEET 1 OF 7	

● **OUTSIDE DIMENSION :**

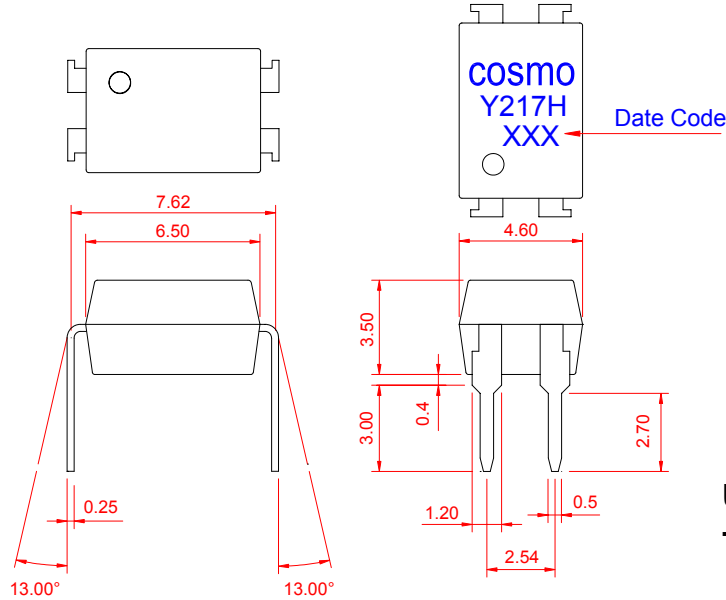

Unit : mm
Tolerance : ±0.2mm

● **Turn On / Turn Off time**

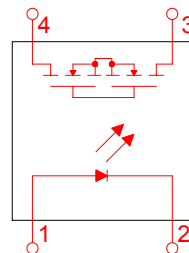
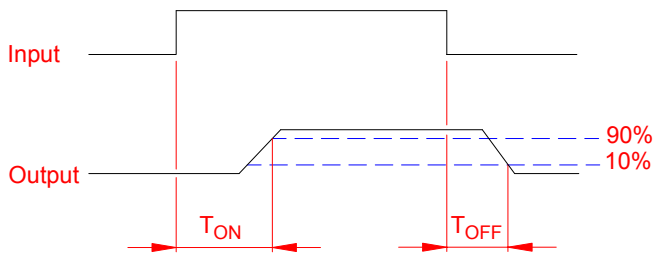

1 FORM A
NORMALLY OPEN

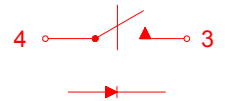

● **Absolute Maximum Ratings**

(Ta=25)

Emitter (Input)	Detector (Output)
Reverse Voltage 5.0V	Output Breakdown Voltage ± 200V
Continuous Forward Current 50mA	Continuous Load Current ± 180mA
Peak Forward Current 1A	Power Dissipation 500mW
Power Dissipation 100mW	
Derate Linearly from 25 1.3mW/	
General Characteristics	
Isolation Test Voltage 5000VACrms	Storage Temperature Range -40 to +125
Isolation Resistance	Operating Temperature Range ... -40 to +85
Vio=500V , Ta=25 10 ¹⁰ Ω	Junction Temperature 100
Total Power Dissipation 550mW	Soldering Temperature ,
Derate Linearly from 25 2.5mW/	2mm from case , 10 sec 260

PRODUCT SPECIFICATION

RoHS Compliance

DATE : 02/12/2008

cosmo ELECTRONICS CORPORATION	SOLID STATE RELAY - MOSFET OUTPUT KAQY217H	NO.60M00016	REV.
		SHEET 2 OF 7	2

● Electro-optical Characteristics

(Ta=25)

Parameter	Symbol	Conditions	Min.	Typ.	Max.	Unit.
Emitter (Input)						
Forward Voltage	V_F	$I_F=10\text{mA}$		1.2	1.5	V
Operation Input Current	$I_{F\text{ON}}$	$V_L=\pm 20\text{V}$, $I_L=100\text{mA}$, $t=10\text{ms}$			5.0	mA
Recovery Input Current	$I_{F\text{OFF}}$	$V_L=\pm 20\text{V}$, $I_L=5\mu\text{A}$	0.2			mA
Detector (Output)						
Output Breakdown Voltage	V_B	$I_B=50\mu\text{A}$	200			V
Output Off-State Leakage	$I_{T\text{OFF}}$	$V_T=200\text{V}$, $I_F=0\text{mA}$		0.2	1	μA
I/O Capacitance	C_{ISO}	$I_F=0$, $f=1\text{MHz}$		6		pF
ON Resistance	R_{ON}	$I_L=100\text{mA}$, $I_F=10\text{mA}$		6	15	
Turn-On Time	T_{ON}	$I_F=10\text{mA}$, $V_L=\pm 20\text{V}$ $t=10\text{ms}$, $I_L=\pm 100\text{mA}$		0.4	1.0	ms
Turn-Off Time	T_{OFF}			0.3	1.0	ms

● Schematic and Wiring Diagrams

Schematic	Output Configuration	Load	Connection	Wiring Diagrams
	1a	AC/DC	-	

PRODUCT SPECIFICATION

RoHS Compliance

DATE : 02/12/2008

cosmo ELECTRONICS CORPORATION	SOLID STATE RELAY - MOSFET OUTPUT KAQY217H	NO.60M00016	REV. 2
		SHEET 3 OF 7	

● Data Curve

Load current vs. ambient temperature
 Allowable ambient Temperature :
 -40 to +85

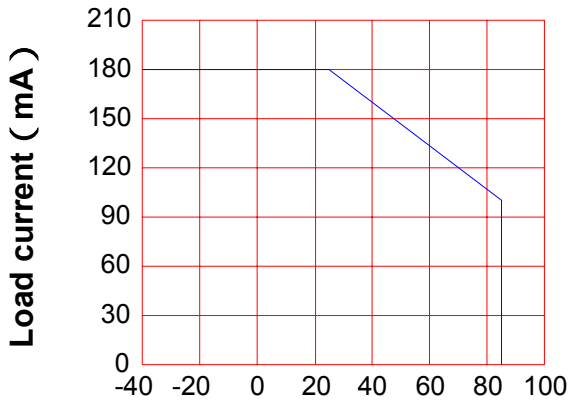

Ambient temperature Ta (°)

On resistance vs. ambient temperature
 across terminals 3 and 4 pin
 LED current : 5mA
 Continuous load current : 180mA (DC)

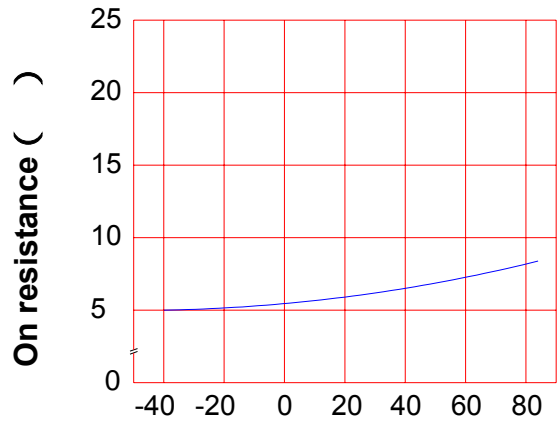

Ambient temperature Ta (°)

Turn On Time vs. ambient temperature
 Load voltage 200V (DC)
 LED current : 5mA
 Continuous load current : 180mA (DC)

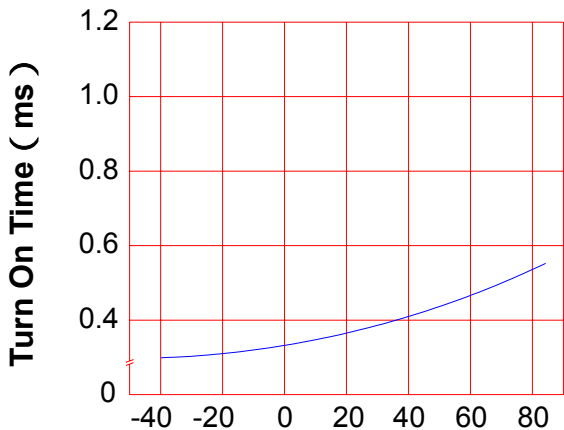

Ambient temperature Ta (°)

Turn Off Time vs. ambient temperature
 Load voltage 200V (DC)
 LED current : 5mA
 Continuous load current : 180mA (DC)

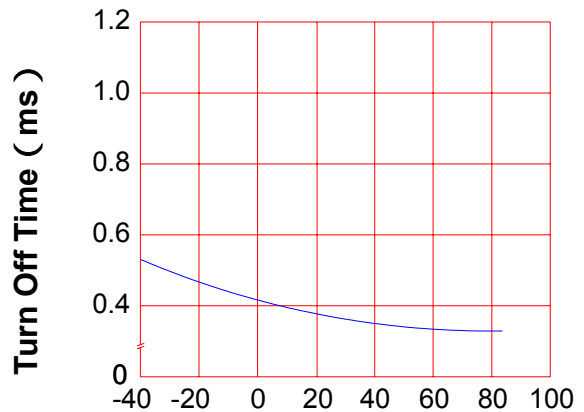

Ambient temperature Ta (°)

PRODUCT SPECIFICATION

RoHS Compliance

DATE : 02/12/2008

cosmo ELECTRONICS CORPORATION	SOLID STATE RELAY - MOSFET OUTPUT KAQY217H	NO.60M00016	REV. 2
		SHEET 4 OF 7	

LED operate current vs.
ambient temperature

Load Voltage : 200V (DC)

Continuous load current : 180mA (DC)

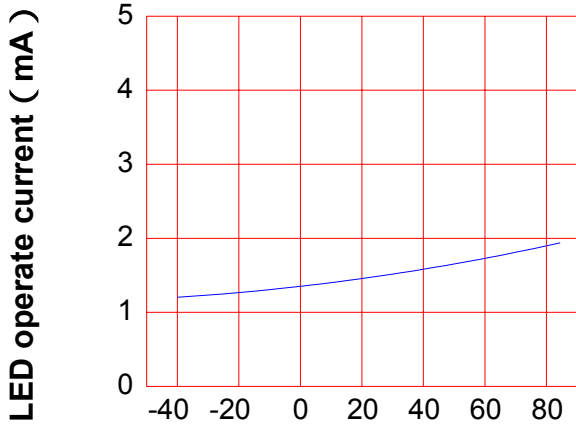

Ambient temperature Ta ()

LED Turn Off current vs.
ambient temperature

Load Voltage : 200V (DC)

Continuous load current : 180mA (DC)

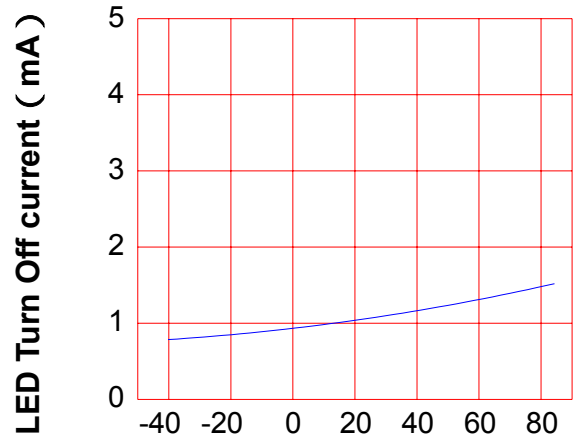

Ambient temperature Ta ()

LED dropout voltage vs.
ambient temperature

LED current : 5 to 50mA

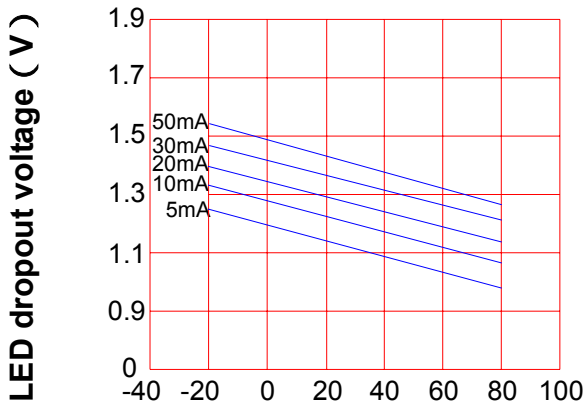

Ambient temperature Ta ()

Voltage vs. current characteristics
of output at MOSFET portion

Measured portion : across terminals
3 and 4 pin

Ambient temperature : 25

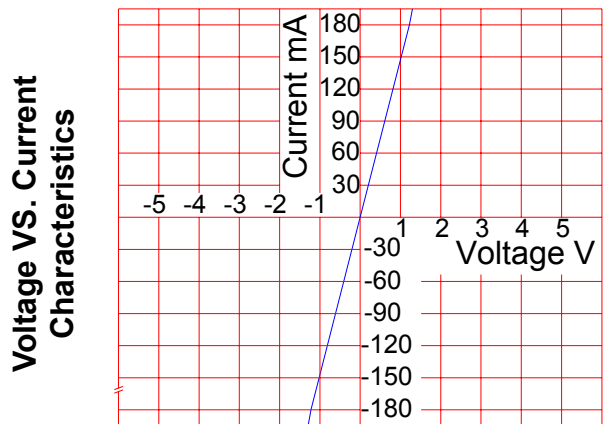

Ambient temperature : 25

PRODUCT SPECIFICATION

RoHS Compliance

DATE : 02/12/2008

cosmo ELECTRONICS CORPORATION	SOLID STATE RELAY - MOSFET OUTPUT KAQY217H	NO.60M00016	REV. 2
		SHEET 5 OF 7	

LED forward current vs. Turn On Time

Across terminals 3 and 4pin

Load voltage : 200V (DC)

Continuous load current : 180mA (DC)

Ambient temperature : 25

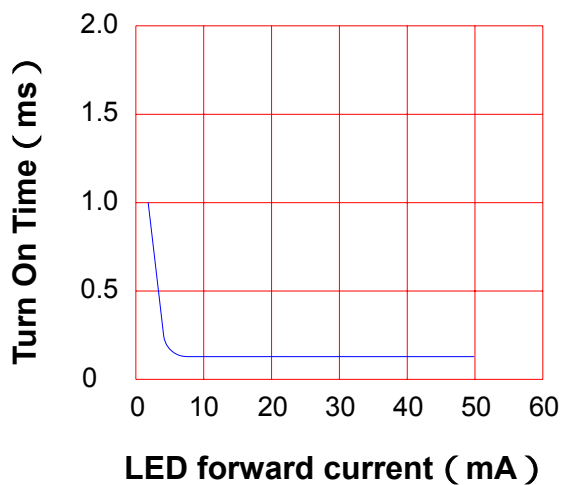

Off state leakage current

Across terminals 3 and 4 pin

Ambient temperature : 25

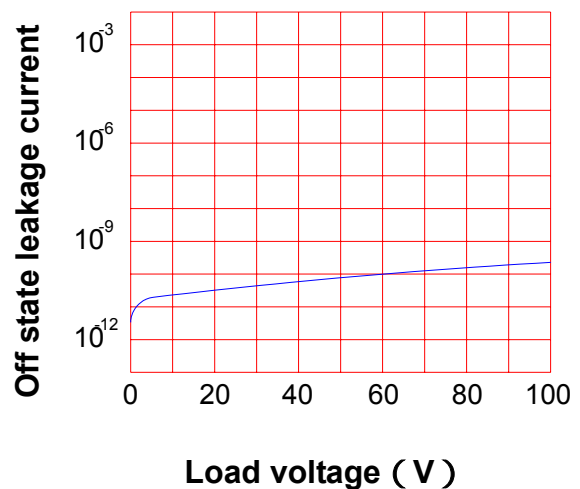

LED forward current vs. Turn Off Time

Across terminals 3 and 4 pin

Load voltage : 200V (DC)

Continuous load current : 180mA (DC)

Ambient temperature : 25

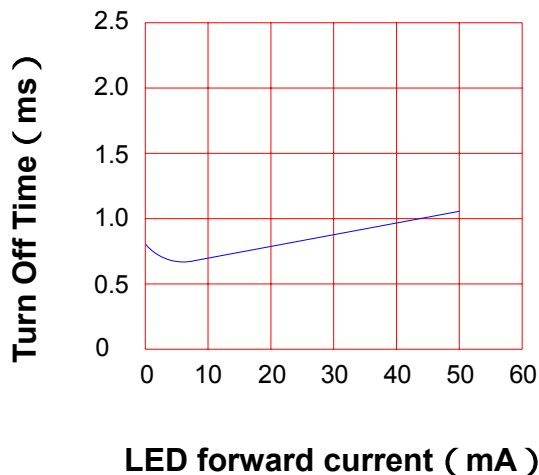

Applied voltage vs. output capacitance

Across terminals 3 and 4 pin

Frequency : 1MHz

Ambient temperature : 25

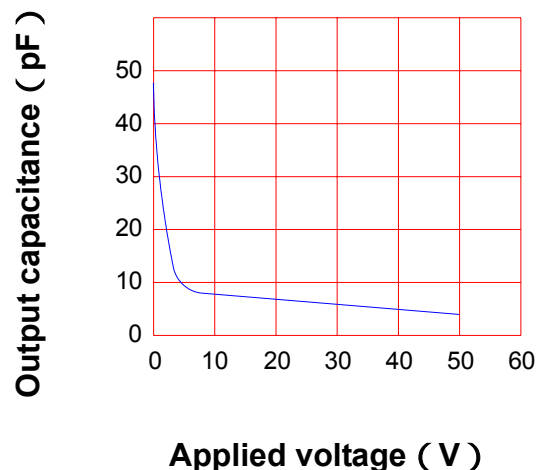

PRODUCT SPECIFICATION

RoHS Compliance

DATE : 02/12/2008

cosmo ELECTRONICS CORPORATION	SOLID STATE RELAY - MOSFET OUTPUT KAQY217H	NO.60M00016	REV. 2
		SHEET 6 OF 7	

● USING METHODS

Examples of resistance value to control LED forward current (I_F)

SSR-MOSFET OUTPUT

($I_F=5\text{mA}$)

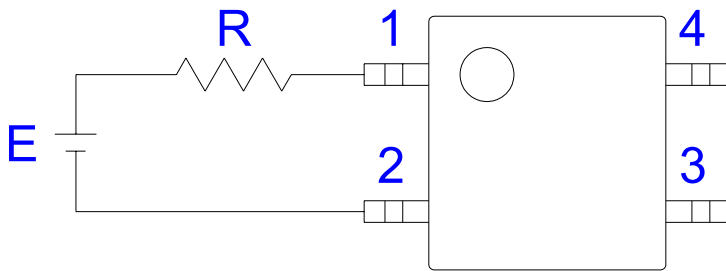

E	R
3.3V	Approx. 330 Ω
5V	Approx. 640 Ω
12V	Approx. 1.9K Ω
15V	Approx. 2.5K Ω
24V	Approx. 4.1K Ω

- (1) LED forward current must be more than 5mA , at E min.
- (2) LED forward current must be less than 50mA , at E max.

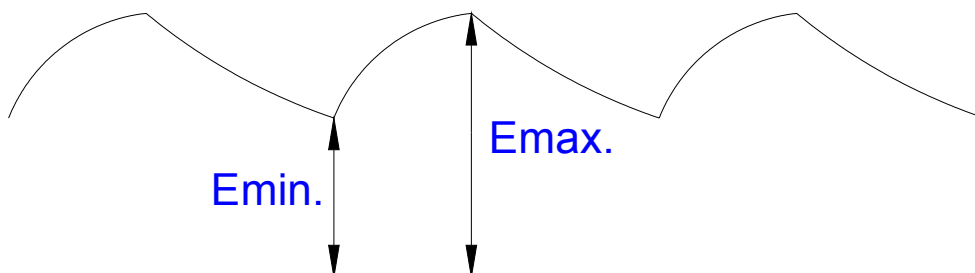

PRODUCT SPECIFICATION

RoHS Compliance

DATE : 02/12/2008

cosmo ELECTRONICS CORPORATION	SOLID STATE RELAY - MOSFET OUTPUT KAQY217H	NO.60M00016	REV. 2
		SHEET 7 OF 7	

● USING METHODS

Regulate the spike voltage generated on the inductive load as follows :

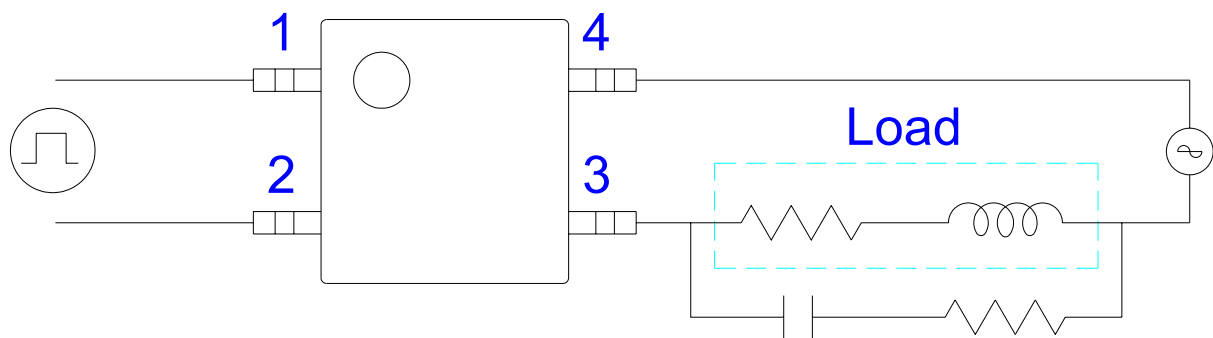
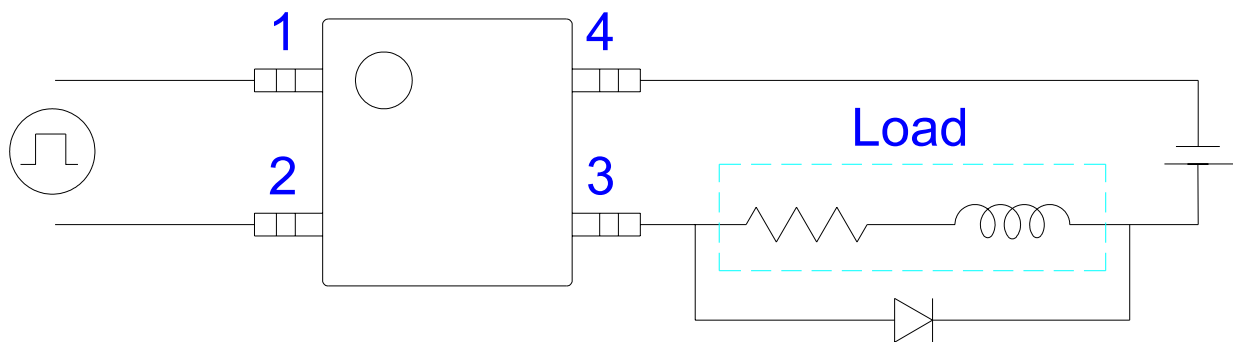

R-C Snubber