

BMA140

Triaxial, analog acceleration sensor

Data sheet

Bosch Sensortec



BOSCH

Invented for life



BMA140 Data sheet

Order code 0 273 141 024

Package type 12-pin LGA

Data sheet version 1.1

Release date 04 April 2008

Notes Specifications are subject to change without notice.
Product photos are for illustration purposes only and may differ from the real product appearance.

 BOSCH	<p style="text-align: center;">BMA140 Data sheet Triaxial, analog acceleration sensor</p>	<p style="text-align: center;">Bosch Sensortec</p>
--	---	--

BMA140 - triaxial $\pm 4g$ analog accelerometer

Key features

- Triaxial, $\pm 4g$ full scale accelerometer
- Standard LGA package with 3mm x 3mm footprint, 0.9mm height
- 2 operation modes: Stand-by- and normal mode
- Ultra-low power consumption:
 - 200 μ A in operation mode
 - 0.9 μ A in stand-by mode
- Only 1 ms turn-on time form stand-by mode to operation mode
- Analog output signals: 3 parallel (X, Y, Z) plus 1 serial (multiplexed X, Y, Z)
- Internal 1.5kHz 1st-order low-pass analog filter
- Customizable corner frequency
- On-chip gain and offset compensation, calibrated on factory level.
- Trigger-able self-test capability of MEMS sensor element and ASIC
- RoHS compliant and Pb-free
- Based on automotive-proven Bosch MEMS wafer-fabrication technology & processes

Typical applications

Tilt, motion and vibration sensing in

- Gaming
- Virtual reality
- Sports- and life style wear
- Cell-phones
- Handhelds, PDAs, PNDs
- Healthcare
- Patient monitoring
- Navigation
- Electronic compass compensation
- Computer peripherals
- Man-machine interfaces

 BOSCH	<p style="text-align: center;">BMA140 Data sheet Triaxial, analog acceleration sensor</p>	<p style="text-align: right;">Bosch Sensortec</p>
--	---	---

The BMA140 in general

The BMA140 is a triaxial low-g acceleration sensor for consumer market applications, available in a standard SMD LGA package with a footprint of 3x3mm² and a height of only 0.9mm. It allows measurements of static as well as dynamic accelerations. Due to its three perpendicular axes it gives the absolute orientation in a gravity field and enables free fall detection. As all other Bosch inertial sensors, the BMA140 is a two-chip arrangement, which combines an application-specific integrated circuit (ASIC) with a three-channel silicon accelerometer, to form a true micro electro mechanical system (MEMS).

The ASIC evaluates the output of the acceleration-sensing element, corresponding to the differential capacitance principle. The underlying MEMS technology processes have proven their capability according to the strictest automotive standards in more than 100 million Bosch inertial sensors a year so far.

The BMA140 provides 3 parallel analog output signals in a $\pm 4g$ acceleration range. All acceleration signals are permanently available on 3 independent analog pads through 33k Ω resistors on each pad. This allows the user defining the signal bandwidth by the mean of external capacitors connected between each channel output and ground. Additional to the parallel X, Y and Z output signals there is the option to multiplex any axis to one supplementary output pin in a freely customized manner. This allows the user to connect the triaxial BMA140 to an economical single channel AD converter without loss of axis information.

For each axis, an independent analog 1.5 kHz 1st-order low-pass filter is included to provide preconditioning of the measured acceleration signal. The corner frequency of this filter can easily be customized. Additional signal preconditioning steps are performed by a digital to analog converter for offset and gain correction purposes with a subsequent signal amplification. The output signals are ratiometric. In the $\pm 4g$ acceleration range the sensor is offering a sensitivity of 300mV/g at 3.0 V supply voltage ($V_{DD} / 10$) and 220 $\mu g/\sqrt{Hz}$ as a typical noise level.

The typical current consumption is 200 μA in operation. Furthermore, the sensor can be switched into a standby mode via supplementary selection pins. In standby mode the sensor module features an ultra low current consumption of typically 0.7 μA . The return from standby mode to full performance conditions is performed in less than 1ms wake up time.

The BMA140 sensor module is ready to use due to test and calibration at factory level. All calibration parameters, e.g. for offset and sensitivity, are stored in an internal EEPROM. The sensor also features full self-test capability for all three axes. It is activated via a single self test activation pin which results in a physical deflection of the seismic mass in the sensing element due to electrostatic forces. Thus, it provides contact and functional testing of the complete signal evaluation path including the MEMS acceleration-sensing element and the evaluation ASIC.

 BOSCH	<p style="text-align: center;">BMA140 Data sheet Triaxial, analog acceleration sensor</p>	<p style="text-align: right;">Bosch Sensortec</p>
--	---	---

CONTENT

1	SPECIFICATION	5
2	ABSOLUTE MAXIMUM RATINGS	7
3	BMA140 FEATURES	8
3.1	GENERAL DESCRIPTION	8
3.2	CHANNEL MULTIPLEXER	9
4	OPERATION	10
4.1	POWER-ON RESET AND POWER-UP SEQUENCE	10
4.2	OPERATION MODE SELECTION	10
4.3	CHANNEL MULTIPLEXER OUTPUT SELECTION	10
4.4	ANALOG OUTPUT ON AX, AY AND AZ	11
4.5	SELF TEST	11
4.6	POLARITY OF THE ACCELERATION OUTPUT	13
4.7	PIN CONFIGURATION (TOP VIEW)	14
4.8	CONNECTING DIAGRAM	15
4.9	HANDLING INSTRUCTIONS	15
5	PACKAGE	16
5.1	OUTLINE DIMENSIONS	16
5.2	PRINTED CIRCUIT BOARD (PCB) DESIGN	17
5.3	MARKING	18
5.4	MOISTURE SENSITIVITY LEVEL AND SOLDERING	19
5.5	TAPE AND REEL	20
5.6	ROHS COMPLIANCY	22
6	LEGAL DISCLAIMER	23
6.1	ENGINEERING SAMPLES	23
6.2	PRODUCT USE	23
6.3	APPLICATION EXAMPLES AND HINTS	23
7	DOCUMENT HISTORY AND MODIFICATION	24

 BOSCH	BMA140 Data sheet Triaxial, analog acceleration sensor	Bosch Sensortec
--	---	-----------------

1 Specification

If not stated otherwise, the given values are maximum values over lifetime and are valid for the specified temperature and voltage ranges.

OPERATING RANGE

Parameter	Symbol	Condition	Min	Typ	Max	Units
Acceleration range	g_{FS4g}	$\pm 4g$		± 4		g
Supply voltage	V_{DD}		1.8	3.0	3.5	V
Digital input low level	VIL	for TEST, ST, SEL.0 and SEL.1			$0.2 * V_{DD}$	V
Digital input high level	VIH	for TEST, ST, SEL.0 and SEL.1	$0.8 * V_{DD}$			V
Supply current in normal mode	I_{DD}	analog and digital		200	290	μA
Supply current in stand-by mode	I_{DDsbm}	analog and digital		0.7		μA
Operating temperature	T_A	full performance	-40		+85	$^{\circ}C$

OUTPUT SIGNAL

Unless stated otherwise output signals are for operation at $V_{DD} = 3.0 V$ and $T = 25^{\circ}C$.

Parameter	Symbol	Condition	Min	Typ	Max	Units
Zero-g voltage	Off	$V_{DD} = 3.0V$	1.455	1.500	1.545	V
			-150	0	+150	mg
		$1.8V \leq V_{DD} \leq 3.5V$		$V_{DD} / 2$		V
Zero-g voltage temperature drift	TCO	$-40^{\circ}C \leq T_A \leq +85^{\circ}C$		± 1		mg/K
Sensitivity	S	$V_{DD} = 3.0V$	0.288	0.300	0.312	V/g
		$1.8V \leq V_{DD} \leq 3.5V$	-4%	$V_{DD} / 10$	+4%	
Bandwidth 1 st order filter	$f_{.3dB}$	with 1nF connected to Ax, Ay, Az		1.500		kHz
Nonlinearity	NL	best fit straight line		± 0.5		%FS
Self test response	TST	triggerable via ST pin		0.65		g
Output noise	n_{rms}	rms		220		$\mu g / \sqrt{Hz}$

 BOSCH	BMA140 Data sheet Triaxial, analog acceleration sensor	Bosch Sensortec
--	---	-----------------

SENSOR PERFORMANCE AND OPERATING CONDITIONS

Parameter	Symbol	Condition	Min	Typ.	Max	Units
Start-up time ¹	T_{st_up}	with 1nF connected to Ax, Ay, Az		3		ms
Wake-up time ²	T_{w_up}	with 1nF connected to Ax, Ay, Az		1		ms
Output resistance	R_x, R_y, R_z	On chip		33		k Ω
Pull-down resistance	$R_{pull\downarrow}$	on ST and TEST pad		20		k Ω
Maximal load on AMUX	C_L				25	pF

MECHANICAL TRAIT

Parameter	Symbol	Condition	Min	Typ	Max	Units
Cross axis sensitivity	\bar{S}	relative contribution between 3 axes		0.2		FS%
Alignment error	δ_a	relative to package outline		± 0.5		°

¹ The start-up time is the total duration between application of the voltage supply and obtaining analog signals on the three channels with less than 1% (of full scale) error between signal and respective asymptotic values.

² The wake-up time is the total duration between transiting from stand-by to normal mode and obtaining analog signals on the three channels with less than 1% (of full scale) error between signal and respective asymptotic values.

 BOSCH	<p style="text-align: center;">BMA140 Data sheet Triaxial, analog acceleration sensor</p>	<p style="text-align: right;">Bosch Sensortec</p>
--	---	---

2 Absolute maximum ratings

Parameter	Condition / Symbol	Min	Max	Units
Extended supply voltage	V_{DD_ext} 0°C to 85°C	1.72	3.55	V
Supply voltage limit	V_{DD_Limit}	-0.3	3.60	V
Pad voltage	V_{pad}	$V_{ss}-0.3$	$V_{dd}+0.3$	V
Storage temperature	T_{store}	-50	+150	°C
Mechanical shock	duration $\leq 100\mu s$		10,000	g
	duration $\leq 500\mu s$		5,000	g
	duration $\leq 1.0ms$		3,000	g
	free fall onto hard surfaces		1.5	m
ESD	HBM at any pin		2.0	kV
	CDM		500	V

 BOSCH	BMA140 Data sheet Triaxial, analog acceleration sensor	Bosch Sensortec
--	---	-----------------

3 BMA140 features

3.1 General description

The BMA140 is a fully calibrated, triaxial low-g analog acceleration sensor. It allows measurements of static as well as dynamic accelerations in all three dimensions. Due to its three perpendicular axes it gives the absolute orientation in a gravity field and enables free-fall detection. The sensor is set up as a two-chip arrangement consisting of a three-channel capacity differential MEMS acceleration-sensing element and an application specific integrated circuit (ASIC). Both parts are embedded in a standard, surface mountable land grid array (LGA) package. In the following, the LGA packed two-chip arrangement is defined as sensor module.

The accelerometer features a low-pass characteristic, with a bandwidth limited to 1.5 kHz (nominal value). This value can further be reduced using external capacitors to improve or customize noise level. It is advised to reduce bandwidth to minimum value required in the application.

The bandwidth of all output pins can be selected by the value of the capacitors connected to the AX, AY and AZ output. Each channel behaves like an independent low-pass RC filter, given by the internal 33kΩ resistor and the external capacitor. The resulting RC low pass filter on AX, AY and AZ is also valid for the multiplexer output pin. Do not connect an additional external capacitor on the multiplexer output pin. Refer to chapter 4.8 for details.

3.1.1 MEMS element

The production of the sensing element is based on standard semiconductor- and standard MEMS processes. The main steps are layer deposition, layer masking and layer structuring in a technology cycle, similar to the standard semiconductor manufacturing. In detail, the process cycle starts with the deposition of a thick epitaxial layer on a sacrificial oxide. The large thickness allows the design of working capacitances of up to 1pF. The poly-layer is patterned by deep reactive ion etching in an inductively coupled plasma (DRIE-ICP, the so-called Bosch process). A large aspect ratio and a very high anisotropy is achieved by periodic passivation of the side walls in between the etch intervals. Afterwards the sacrificial layer is removed. The sensing element is hermetically sealed by a bulk micro-machined cap to prevent damages of the structure by dicing, packaging and operation of the device.

3.1.2 ASIC

The ASIC is produced in a standard CMOS process. It evaluates, corrects and amplifies the output signal of the MEMS acceleration-sensing element. Simplified considered, the ASIC consists mainly out of 3 capacity voltage converters and 3 signal conditioners, a channel multiplexer, a digital to analog converter an EEPROM memory and an internal RC oscillator. For customized testing an electrostatic force to the sensor electrodes can be induced and compared with a nominal condition. Thus, a general statement about the functional capability of the sensor module can be made at any time.

 BOSCH	BMA140 Data sheet Triaxial, analog acceleration sensor	Bosch Sensortec
--	--	-----------------

3.2 Channel multiplexer

On the Ax, Ay, and Az output pin there is always the possibility to grip the continuous analog output signals of the corresponding axis. Additional to these continuously available signals, there is the possibility to multiplex any of the 3 axis fully customized to one separate AMUX output pin via an internal channel multiplexer. This e.g. enables the option to read out all three axes at only one output pin.

Which of the acceleration signal of the 3 axis is actually multiplexed to the AMUX output pin – or in which sequence – can be selected through the corresponding SEL.0 and SEL.1 pins of the sensor module (see chapter 4.3). Do not connect any external capacitor on the AMUX output pin.

 BOSCH	<p style="text-align: center;">BMA140 Data sheet Triaxial, analog acceleration sensor</p>	<p style="text-align: right;">Bosch Sensortec</p>
--	---	---

4 Operation

4.1 Power-on reset and power-up sequence

An internal power-on reset (POR) is implemented to ensure proper reset during power-up. The POR is active during 100µs (typical value). For this application the power on sequence only occurs when a battery or an external supply is connected to VDD. Normally GND is connected first. There should be a coupling capacitor connected between VDD and GND as shown in chapter 4.8. Low resistance connections are required between decoupling capacitor and sensor pads (< 100Ohms).

4.2 Operation mode selection

Two operation modes can be selected: NORMAL and STAND-BY mode. The operation modes are selected by setting SEL1 and SEL0 according to the table given below.

SEL.1	SEL.0	Operation Mode	Operation feature	Current Consumption	Description
0	0	NORMAL	full performance	200 µA (typical)	Acceleration measurements of all axes (Ax, Ay, Az plus AMUX) are performed. All sensor features are enabled.
0	1				
1	0				
1	1	STAND-BY	current saving	0.7 µA (typical)	Acceleration measurements are stopped, Ax, Ay, Az and AMUX signals are driven to GND through 110kΩ resistors.

When stand-by mode is activated, all sensor electrodes are connected to Vss. No electrostatic forces are generated to the electrodes. Power consumption is drastically reduced in this mode. All blocks are disabled except some bias generation and power-on reset generation. This feature enables ultra low power mode operation if the sensor module is turned into stand-by mode e.g. between each acceleration measurement.

4.3 Channel multiplexer output selection

Using the channel multiplexer, it is possible to choose specific axis output signals on the AMUX pin. This allows the user to connect the triaxial BMA140 to an economical single channel AD converter without loss of axis information. The channel selection on AMUX is performed by setting SEL.0 and SEL.1 according to the following table. By setting both, SEL.0 and SEL.1 to 1, the sensor module is set to stand-by mode.

SEL.1	SEL.0	Operation Mode	Output signal on channel multiplexer serial output pin (AMUX)
0	0	NORMAL	Ax, Ay, Az plus AMUX = Ax
0	1	NORMAL	Ax, Ay, Az plus AMUX = Ay
1	0	NORMAL	Ax, Ay, Az plus AMUX = Az
1	1	STAND-BY	Sensor module set to stand-by mode, no signal on X, Y, Z and AMUX

IMPORTANT NOTE: SEL.0 and SEL.1 transitions must be synchronous within a 20ns tolerance to avoid the ASIC to switch to an unwanted state at transitions (valid for the four possible transitions where the two signals SEL.0 and SEL.1 have to change simultaneously). See also the figure given below.

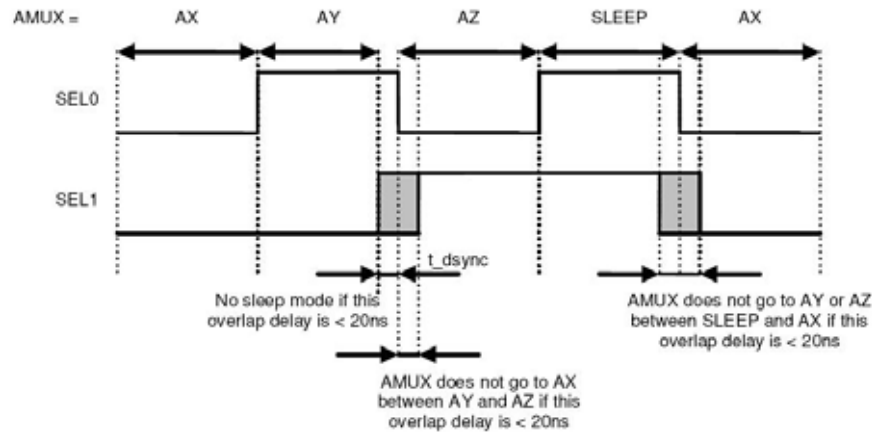

4.4 Analog output on Ax, Ay and Az

By selecting the operation mode to “Normal” all 3 axis provide acceleration measurement signals simultaneously on the Ax, Ay and Az pins according to the following equation.

$$A_x = \left(\frac{V_{DD}}{2} + S \cdot a_x \right) \quad A_y = \left(\frac{V_{DD}}{2} + S \cdot a_y \right) \quad A_z = \left(\frac{V_{DD}}{2} + S \cdot a_z \right)$$

Ax, Ay and Az are the vector components of the acting acceleration. According to chapter 1 the sensitivity in the $\pm 4g$ range corresponds to $V_{DD}/10$ given in V/g. This means, the maximal default acceleration range is $\pm 4g$.

4.5 Self test

The sensor features an on-chip self-test which can be activated by using the corresponding self test input pin. The self test is realized by a physical deflection of the seismic mass due to an electrostatic force. Thus, it provides contact and functional testing of the complete signal evaluation path including the MEMS acceleration-sensing element and the evaluation ASIC.

The self test is activated by setting the self test activation input pin to logic 1. The test acts on all three channels simultaneously. The typical change in output will be a static offset of approximately +0.65g for x-, y- and for z-axis (nominal value). For the $\pm 4g$ acceleration range this corresponds to an nominal output signal delta of $\Delta U_{out, nom} [v] = (V_{DD} [v] / 10) \times 0.65$, to be added as a static voltage offset to the current output signal Xout, Yout and Zout. The self test

response remains as a static offset on the XYZ and AMUX output as long as the self test activation input pin is not set back to logic 0.

Simplified, while the self test is activated, any acceleration or gravitational force applied to the sensor will be observed in the output signal as a superposition of both acceleration and self test signal.

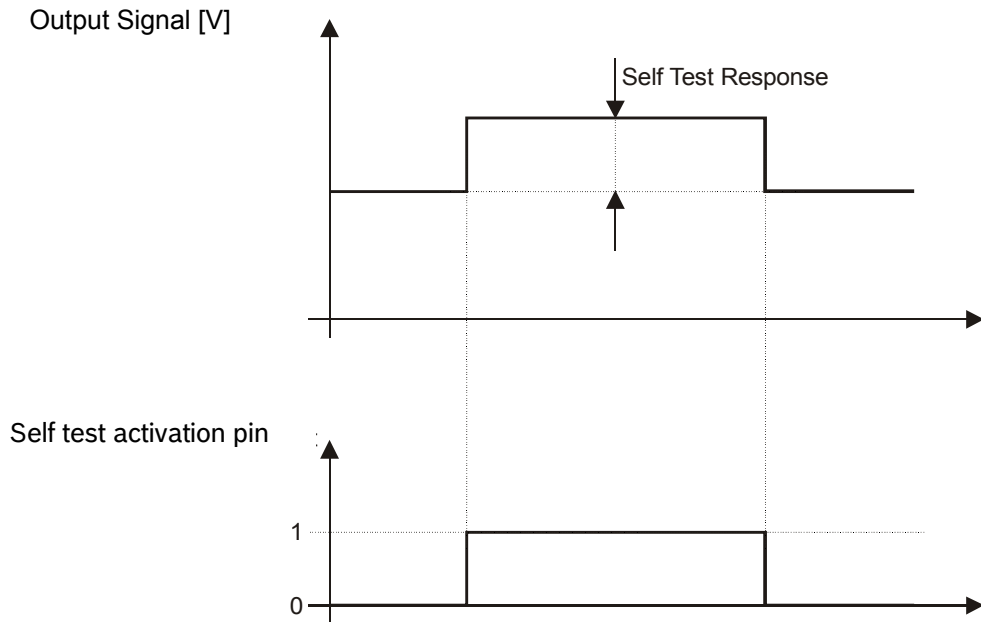

4.6 Polarity of the acceleration output





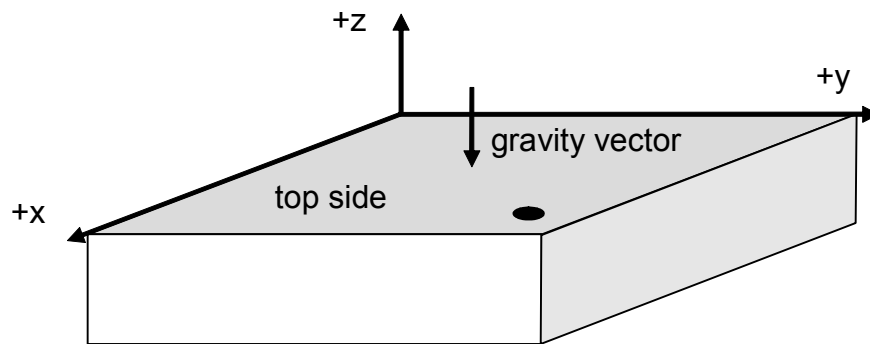

If the sensor is accelerated into the indicated directions, the corresponding channels will deliver a positive acceleration signal (dynamic acceleration).

Example: If the sensor is at rest or at uniform motion in a gravity field according to the figure given below, the output signals are:

- $\pm 0g$ for the x channel
- $\pm 0g$ for the y channel
- $+ 1g$ for the z channel



The following table lists all corresponding output signals on Ax, Ay, and Az while the sensor is at rest or at uniform motion in a gravity field under assumption of a top down gravity vector as shown above.

Sensor Orientation (gravity vector ↓)						
Output Signal Ax	0g / 1.5V	+1g / 1.8V	0g / 1.5V	-1g / 1.2V	0g / 1.5V	0g / 1.5V
Output Signal Ay	-1g / 1.2V	0g / 1.5V	+1g / 1.8V	0g / 1.5V	0g / 1.5V	0g / 1.5V
Output Signal Az	0g / 1.5V	0g / 1.5V	0g / 1.5V	0g / 1.5V	+1g / 1.8V	-1g / 1.2V

4.7 Pin configuration (top view)

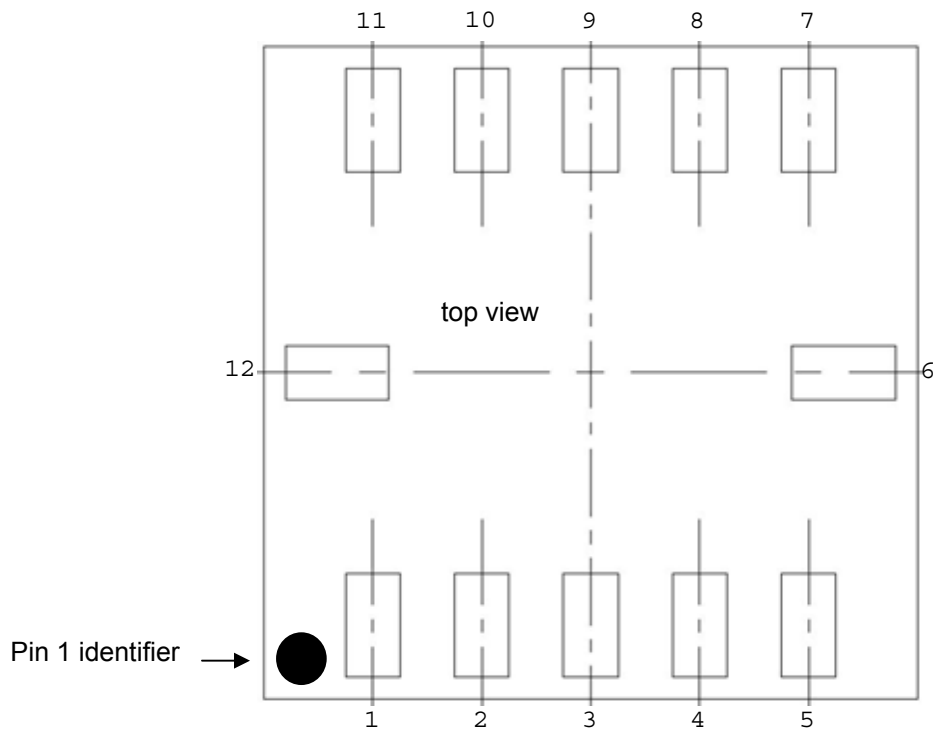

Pin	Name	Digital Analog	Description
01	VDD1	A in	Supply Voltage Connection Pin 1
02	VDD2	A in	Supply Voltage Connection Pin 2
03	GND1	A	Ground Connection Pin 1
04	GND2	A	Ground Connection Pin 2
05	ST	D in	Self Test Activation Pin
06	SEL.1	D in	Channel Multiplexer Selection Pin 2 ¹⁾
07	TEST	D in/out	Do not connect! Pin used for factory trimming and calibration!
08	AZ	A out	Z Acceleration Parallel Output Pin
09	AY	A out	Y Acceleration Parallel Output Pin
10	AX	A out	X Acceleration Parallel Output Pin
11	AMUX	A out	Channel Multiplexer Serial Output Pin
12	SEL.0	D in	Channel Multiplexer Selection Pin 1

¹⁾ Connect to GND if Standby mode and multiplexed outputs will not be used.

4.8 Connecting diagram

The following external components (C_1 and C_2) are recommended to decouple the power source.

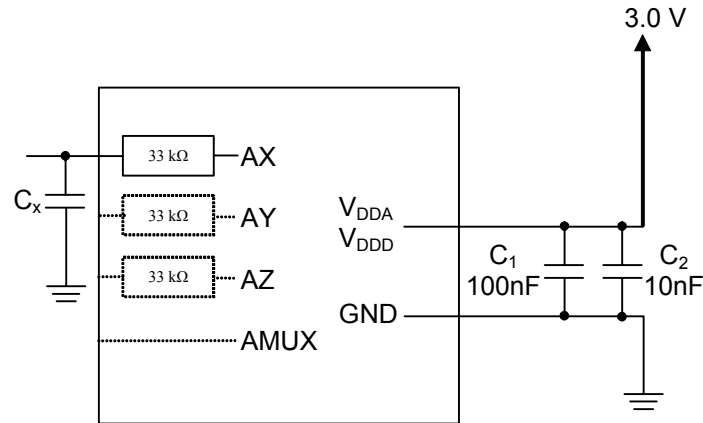

The typical bandwidth of the sensor module without subsequent RC low pass filtering is 1.5kHz. According to the following equation a customized cut-off frequency can be realized by a simple dimension of C_x (C_y , C_z) to create a RC low pass filter. The below given equation corresponds to the x-axis but it is also representative for the y- and z-axis. The AMUX cut-off frequency output behavior is directly linked up to C_x , C_y & C_z . Do not connect an additional external capacitor on the multiplexer output pin.

$$f_{c_x} = \frac{1}{2\pi \cdot 33k\Omega \cdot c_x}$$

4.9 Handling instructions

Micromechanical sensors are designed to sense acceleration with high accuracy even at low amplitudes and contain highly sensitive structures inside the sensor element. The MEMS sensor can tolerate mechanical shocks up to several thousand g's. However, these limits might be exceeded in conditions with extreme shock loads such as e.g. hammer blow on or next to the sensor, dropping of the sensor onto hard surfaces etc.

We strongly recommend to avoid g-forces beyond the specified limits (see section 2) during transport, handling and mounting of the sensors in a defined and qualified installation process.

This device has built-in protections against high electrostatic discharges or electric fields (e.g. 2kV HBM); however, anti-static precautions should be taken as for any other CMOS component. Unless otherwise specified, proper operation can only occur when all terminal voltages are kept within the supply voltage range. Unused inputs must always be tied to a defined logic voltage level. Please refer to the separately available document "Handling, soldering & mounting instructions" for the BMA140.

5 Package

5.1 Outline dimensions

The sensor housing is a standard LGA package. It is compliant with JEDEC Standard MO-229 Type VGGD-3. Its dimensions are the following:

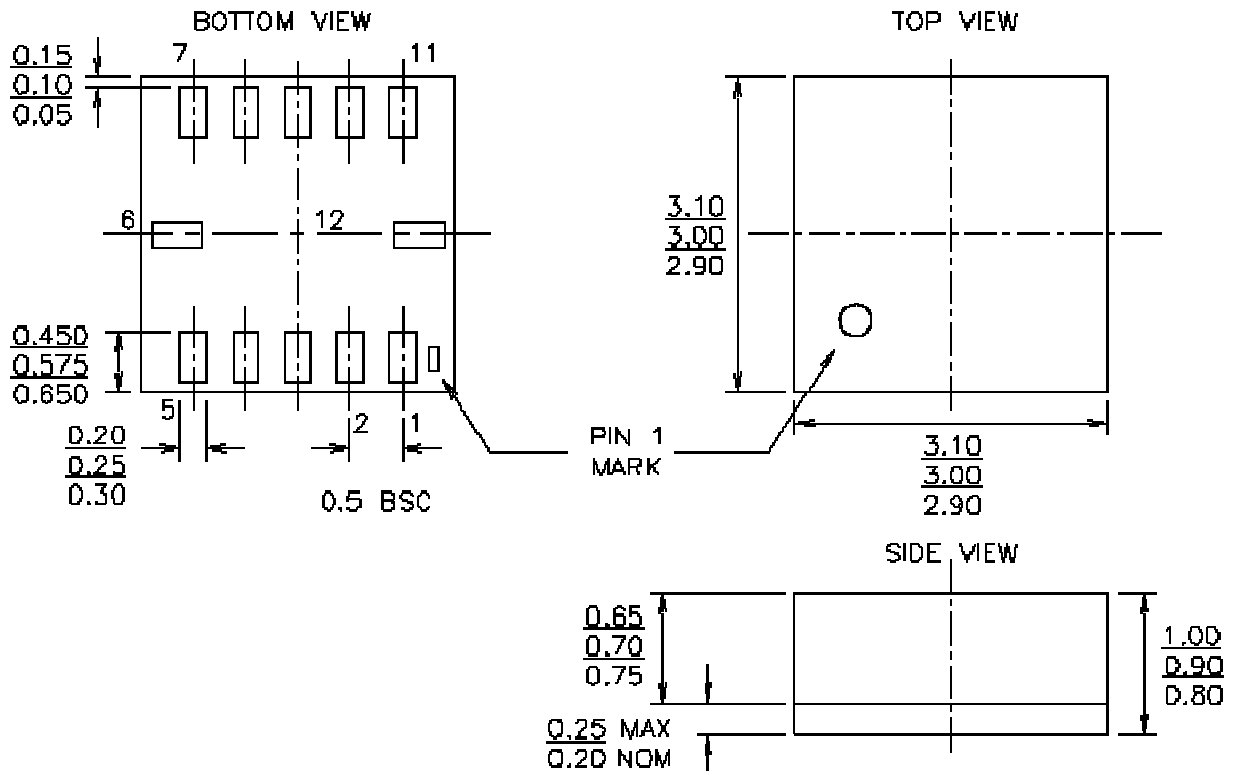

5.2 Printed circuit board (PCB) design

The following PCB design is recommended in order to minimize solder voids and stress acting on the sensing element. All dimensions are given in mm.

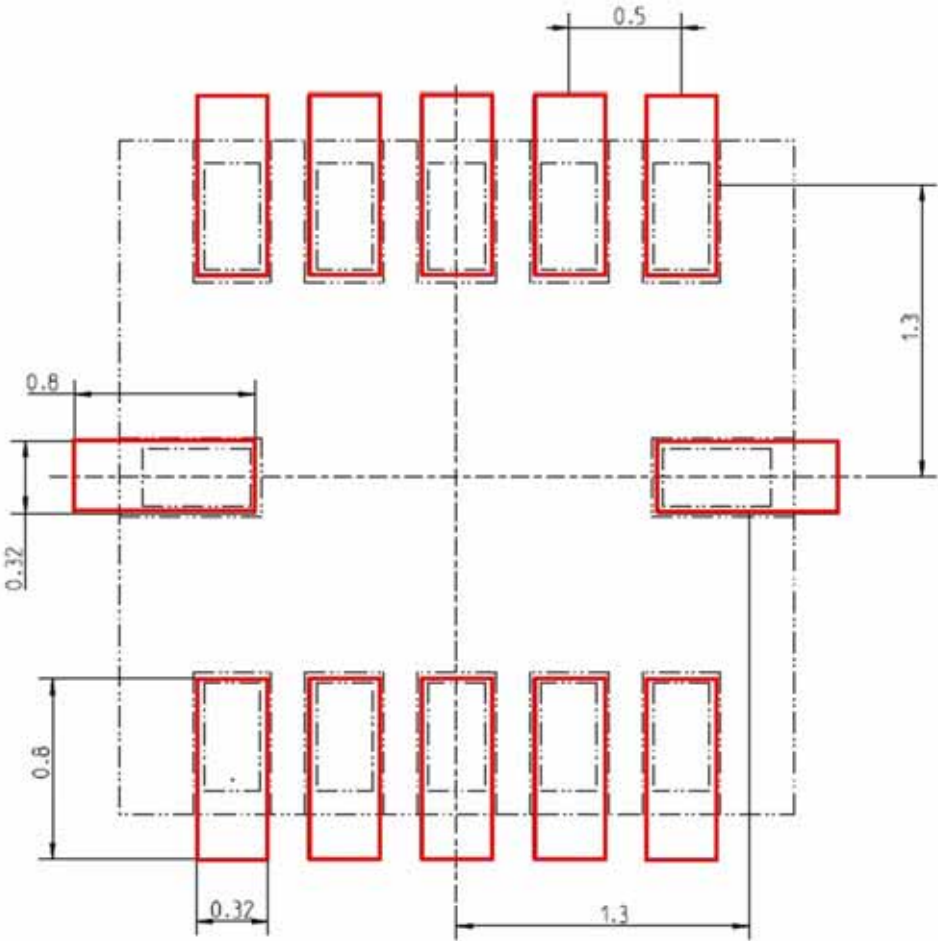

 BOSCH	<p style="text-align: center;">BMA140 Data sheet Triaxial, analog acceleration sensor</p>	<p style="text-align: right;">Bosch Sensortec</p>
--	---	---

5.3 Marking

5.3.1 Mass production samples

Labeling	Name	Symbol	Remark
<div style="border: 1px solid black; padding: 10px; text-align: center;"> <p>024</p> <p>AYWW</p> <p>● CCC</p> </div>	Product number	024	
	Sub-con ID	A	Coded alphanumerically
	Date code	YWW	Y: year, alpha-numerical 9=2009, A=2010, ... WW: Calendar week, numerical
	Lot counter	CCC	
	Pin 1 identifier	•	

5.3.2 Engineering samples

Labeling	Name	Symbol	Remark
<div style="border: 1px solid black; padding: 10px; text-align: center;"> <p>140e</p> <p>AYWW</p> <p>● 0Cn</p> </div>	Product name	140	BMA140
	Eng. Sample ID	e	Engineering samples are marked with an “e”
	Sub-con ID	A	Coded alphanumerically
	Date code	YWW	Y: year, alpha-numerical ..,9=2009, A=2010,.. WW: Working week, numerical
	Lot counter	0Cn	e.g. n = 1 → = C1-Sample
	Pin 1 identifier	•	

5.4 Moisture sensitivity level and soldering

The moisture sensitivity level of the BMA140 sensors corresponds to JEDEC Level 1, see also

- IPC/JEDEC J-STD-020C “Joint Industry Standard: Moisture/Reflow Sensitivity Classification for non-hermetic Solid State Surface Mount Devices”
- IPC/JEDEC J-STD-033A “Joint Industry Standard: Handling, Packing, Shipping and Use of Moisture/Reflow Sensitive Surface Mount Devices”.

The sensor fulfils the lead-free soldering requirements of the above-mentioned IPC/JEDEC standard, i.e. reflow soldering with a peak temperature up to 260°C.

Profile Feature	Pb-Free Assembly
Average Ramp-Up Rate ($T_{S_{max}}$ to T_p)	3° C/second max.
Preheat	
- Temperature Min ($T_{S_{min}}$)	150 °C
- Temperature Max ($T_{S_{max}}$)	200 °C
- Time ($t_{S_{min}}$ to $t_{S_{max}}$)	60-180 seconds
Time maintained above:	
- Temperature (T_L)	217 °C
- Time (t_L)	60-150 seconds
Peak/Classification Temperature (T_p)	260 °C
Time within 5 °C of actual Peak Temperature (t_p)	20-40 seconds
Ramp-Down Rate	6 °C/second max.
Time 25 °C to Peak Temperature	8 minutes max.

Note 1: All temperatures refer to topside of the package, measured on the package body surface.

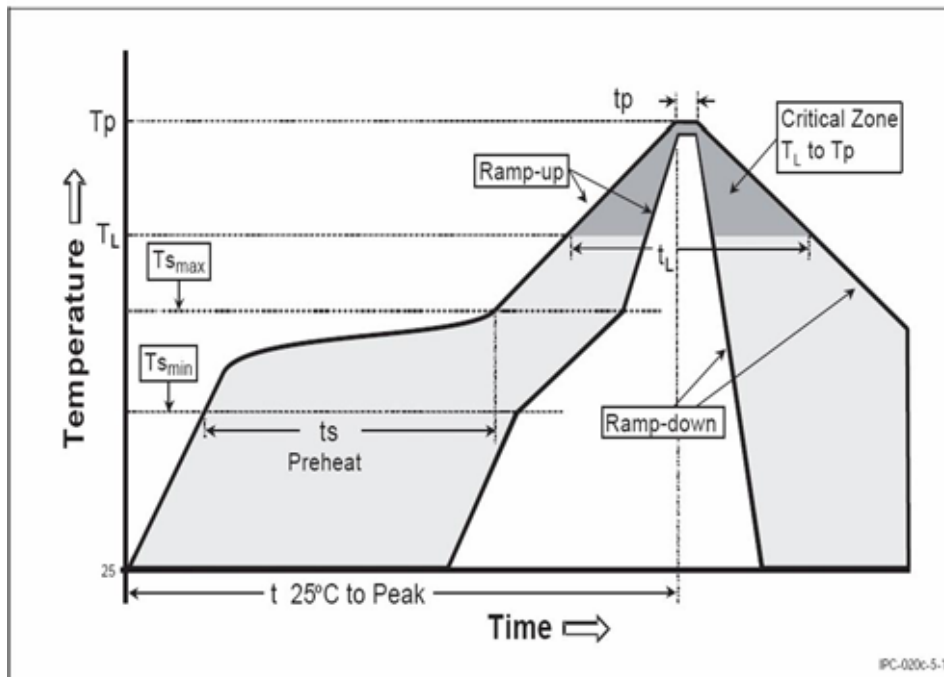

5.5 Tape and reel

The BMA140 is shipped in a standard cardboard box. The box dimensions for one reel are 35cm(L) x 35cm(W) x 6cm(H). One reel contains 5,000 pieces of the BMA140.

The following picture describes the dimensions of the tape used for shipping the BMA140 sensor device. The material of the tape is conductive polysterene (IV).

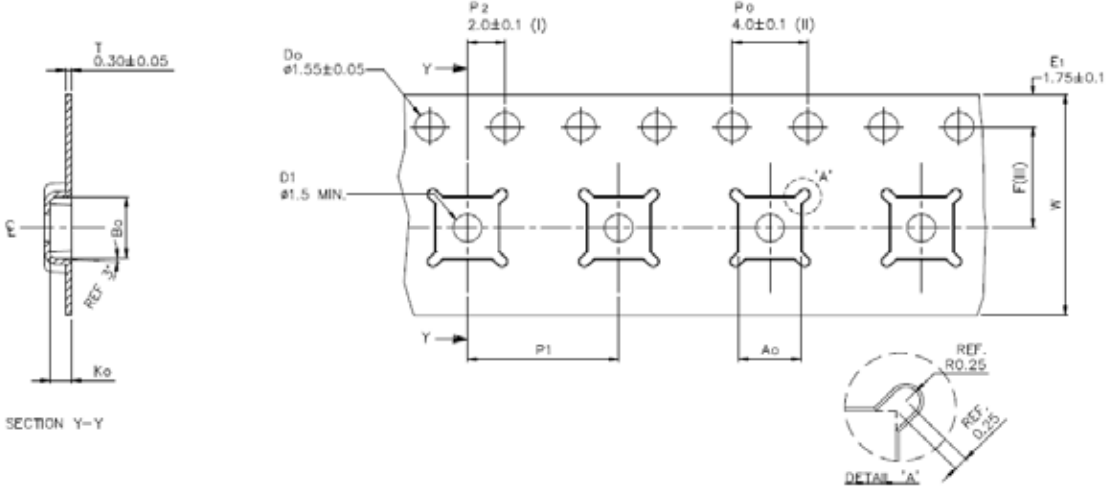



Ao	3.30 +/- 0.1
Bo	3.30 +/- 0.1
Ko	1.10 +/- 0.1
F	5.50 +/- 0.1
P1	8.00 +/- 0.1
W	12.00 +/- 0.3

- (I) Measured from centreline of sprocket hole to centreline of pocket.
- (F) Cumulative tolerance of 10 sprocket holes is ± 0.20.
- (II) Measured from centreline of sprocket hole to centreline of pocket.
- (IV) Other material available.

ALL DIMENSIONS IN MILLIMETRES UNLESS OTHERWISE STATED.

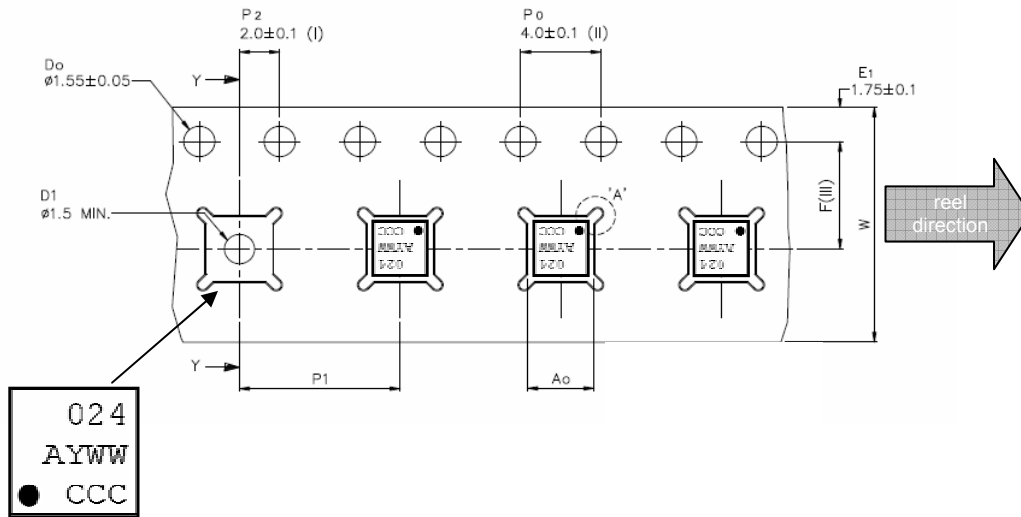
The following figure shows the orientation of the BMA140 devices relative to the tape:



 BOSCH	BMA140 Data sheet Triaxial, analog acceleration sensor	Bosch Sensortec
--	---	-----------------

5.6 RoHS compliancy

The BMA140 sensor meets the requirements of the EC restriction of hazardous substances (RoHS) directive, see also:

Directive 2002/95/EC of the European Parliament and of the Council of 27 January 2003 on the restriction of the use of certain hazardous substances in electrical and electronic equipment.

5.6.1 Note on the internal package structure

Within the scope of Bosch Sensortec's ambition to improve its products and secure the product supply during mass production, Bosch Sensortec qualifies additional sources for the LGA package of the BMA140.

While Bosch Sensortec takes care that all of the technical packages parameters are described above are 100% identical for both sources, there can be differences in the chemical content and the internal structural between the different package sources.

However, as secured by the extensive product qualification process of Bosch Sensortec, this has no impact to the usage or to the quality of the BMA140 product.

 BOSCH	BMA140 Data sheet Triaxial, analog acceleration sensor	Bosch Sensortec
--	---	-----------------

6 Legal disclaimer

6.1 Engineering samples

Engineering Samples are marked with an asterisk (*) or (e). Samples may vary from the valid technical specifications of the product series contained in this data sheet. They are therefore not intended or fit for resale to third parties or for use in end products. Their sole purpose is internal client testing. The testing of an engineering sample may in no way replace the testing of a product series. Bosch Sensortec assumes no liability for the use of engineering samples. The Purchaser shall indemnify Bosch Sensortec from all claims arising from the use of engineering samples.

6.2 Product use

Bosch Sensortec products are developed for the consumer goods industry. They may only be used within the parameters of this product data sheet. They are not fit for use in life-sustaining or security sensitive systems. Security sensitive systems are those for which a malfunction is expected to lead to bodily harm or significant property damage. In addition, they are not fit for use in products which interact with motor vehicle systems.

The resale and/or use of products are at the purchaser's own risk and his own responsibility. The examination of fitness for the intended use is the sole responsibility of the Purchaser.

The purchaser shall indemnify Bosch Sensortec from all third party claims arising from any product use not covered by the parameters of this product data sheet or not approved by Bosch Sensortec and reimburse Bosch Sensortec for all costs in connection with such claims.

The purchaser must monitor the market for the purchased products, particularly with regard to product safety, and inform Bosch Sensortec without delay of all security relevant incidents.

6.3 Application examples and hints

With respect to any examples or hints given herein, any typical values stated herein and/or any information regarding the application of the device, Bosch Sensortec hereby disclaims any and all warranties and liabilities of any kind, including without limitation warranties of non-infringement of intellectual property rights or copyrights of any third party. The information given in this document shall in no event be regarded as a guarantee of conditions or characteristics. They are provided for illustrative purposes only and no evaluation regarding infringement of intellectual property rights or copyrights or regarding functionality, performance or error has been made.

 BOSCH	<p style="text-align: center;">BMA140 Data sheet Triaxial, analog acceleration sensor</p>	<p style="text-align: right;">Bosch Sensortec</p>
--	---	---

7 Document history and modification

Rev.	Chapter	Description of modifications and changes	Date
1.0		Document creation	04-Feb-2008
1.1	1	Update output signal table	04-Apr-2008
	2	Update absolute maximum ratings table	04-Apr-2008